

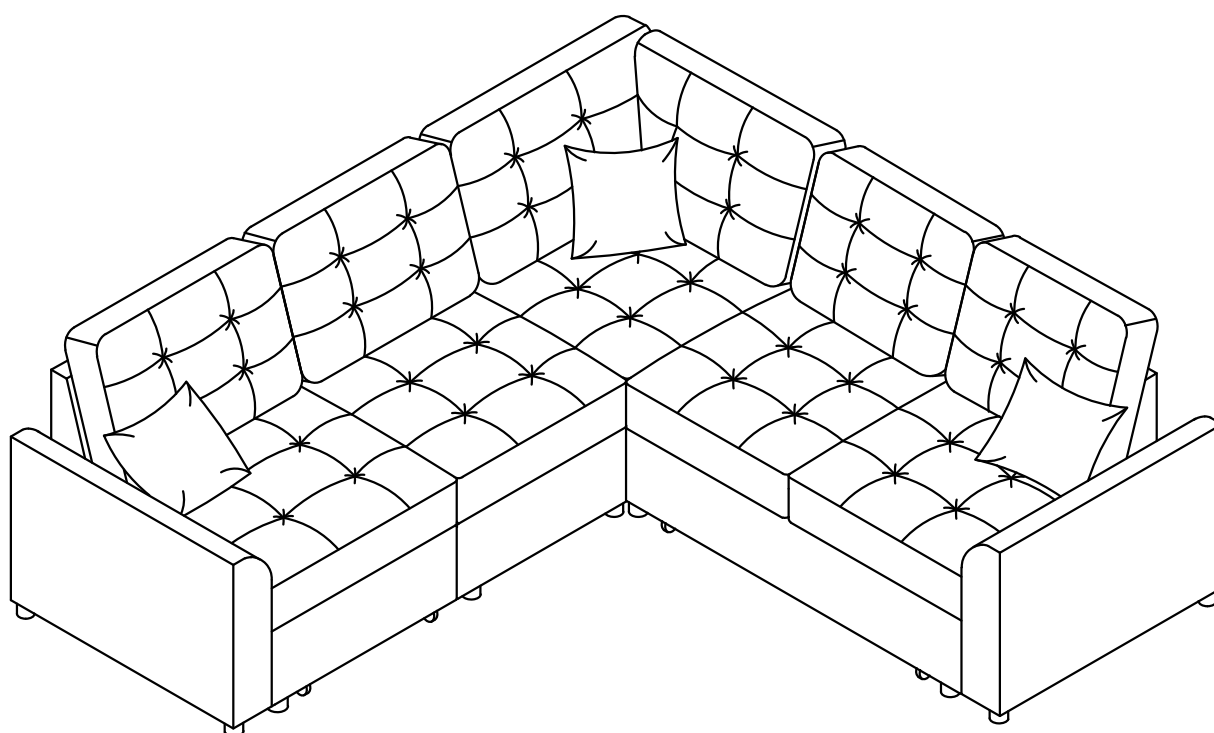

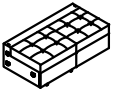

ASSEMBLY INSTRUCTION





ITEM NO.: WF311428-WF311429-WF311430-WF311431





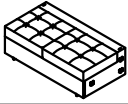



WF311428-COMPONENT LIST

NO.	DRAWING	QTY	DESCRIPTION
B		1	Loveseat Body
E		1	Corner short Back Frame
I		5	Round legs
K		3	Back Cushion

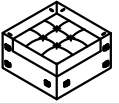

WF311429-COMPONENT LIST

G		1	Chair Body
C		1	Loveseat Back Frame
J		1	Chair Back Frame
N		3	Pillow
I		4	Round legs

WF311430-COMPONENT LIST

D		1	Corner Frame
F		1	Corner Long Back Frame
K		1	Back Cushion
L		1	Corner Long Back Cushion
M		1	Corner Short Back Cushion
I		8	Round legs 4pcs Corner/Arm 4 pcs

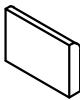
WF311431-COMPONENT LIST

A		1	Left Arm
H		1	Right Arm

PARTS LIST

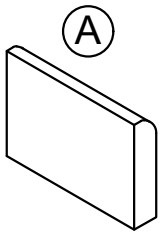
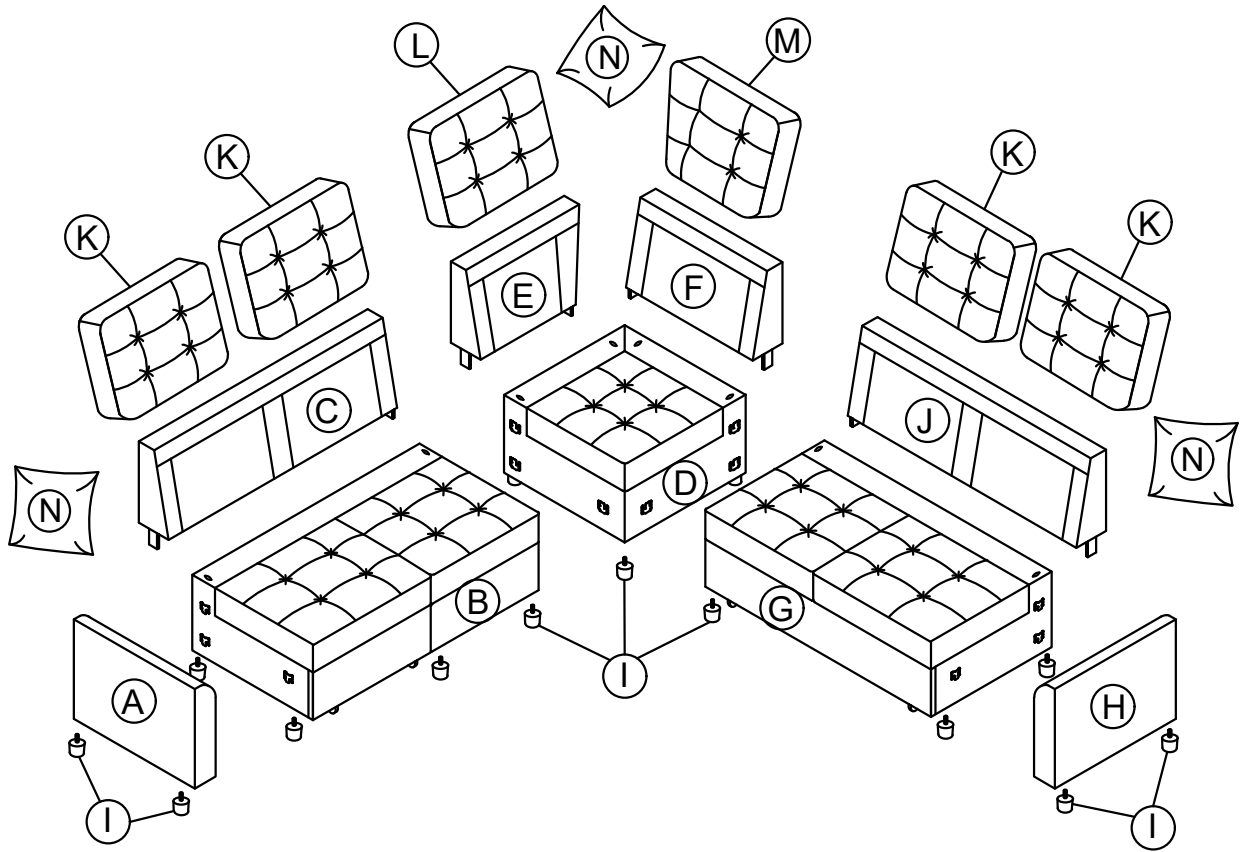

A
Left Arm
X 1PC

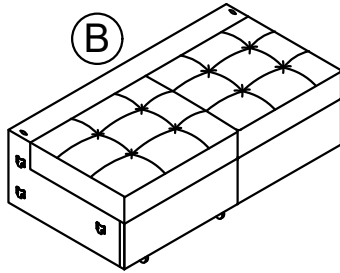

B
Loveseat Body
X 1PC

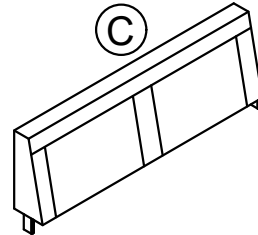

C
Loveseat Backrest
X 1PC

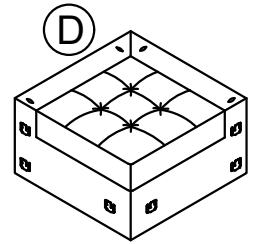

D
Corner Body
X 1PC

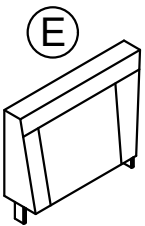

E
Corner Short Backrest
Frame X 1PC

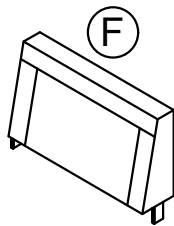

F
Corner Long Backrest
Frame X 1PC

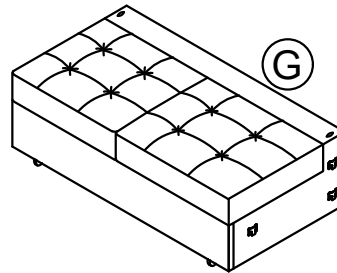

G
Chaise Body
X 1PC

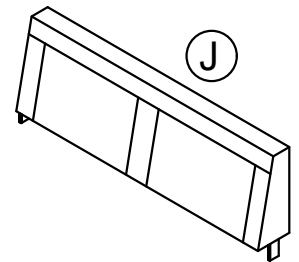

J
Chaise Backrest
X 1PC

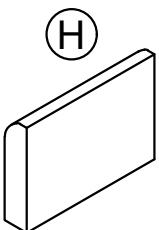

H
Right Arm
X 1PC

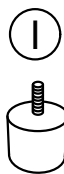

I
Round Leg
X 17 PCS

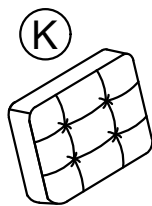

K
Back Cushion
X 4PCS

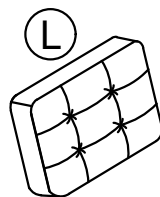

L
Corner Long
Back Cushion
X 1PC



M
Corner Short
Back Cushion
X 1PC

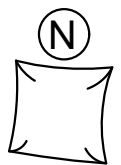

N
Pillow
X 3PCS

STEP 1:

1.1 Attach I x4 to A x1 with Hx1

STEP 3:

3.1 Attach I x4 to D x1

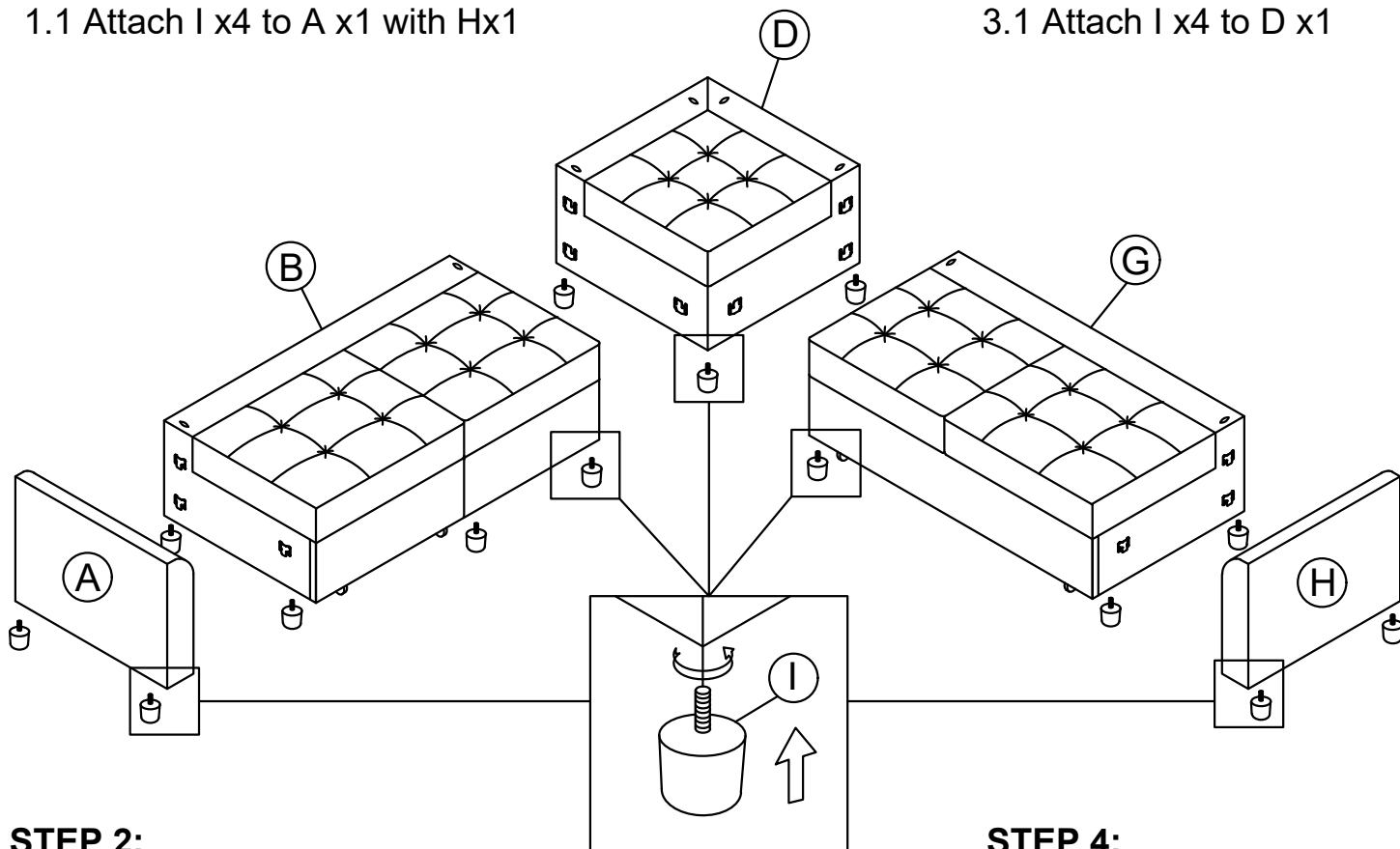

STEP 2:

2.1 Attach I x5 to B x1

STEP 4:

4.1 Attach I x4 to G x1.

STEP 5:

5.1 Attach C x1 to B x1

5.2 Attach E x1 with F x1 to D x1

5.3 Attach J x1 to G x1.

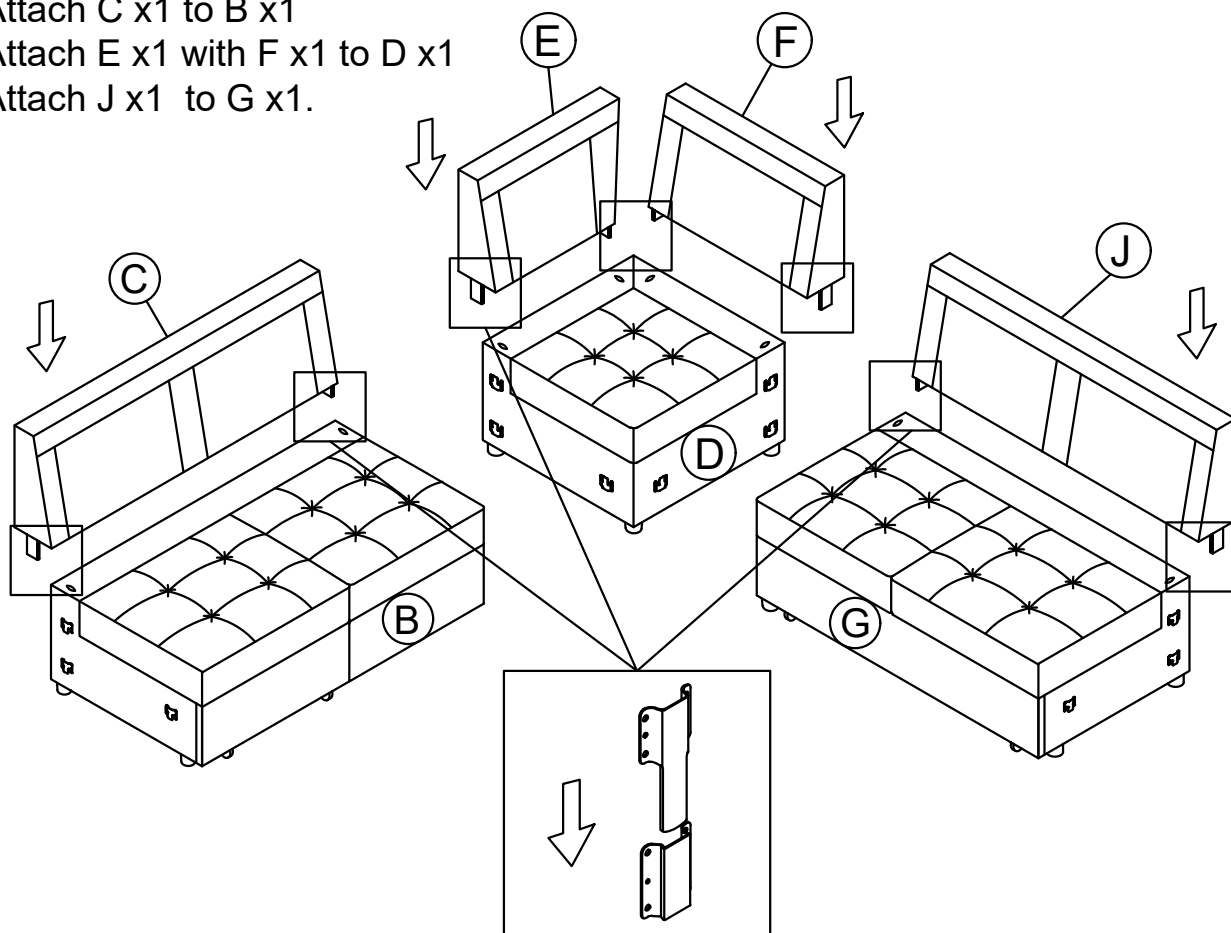

STEP 6:

- 6.1 Attach B x1 to A x1 with D x1
- 6.2 Attach G x1 to H x1 with D x1.

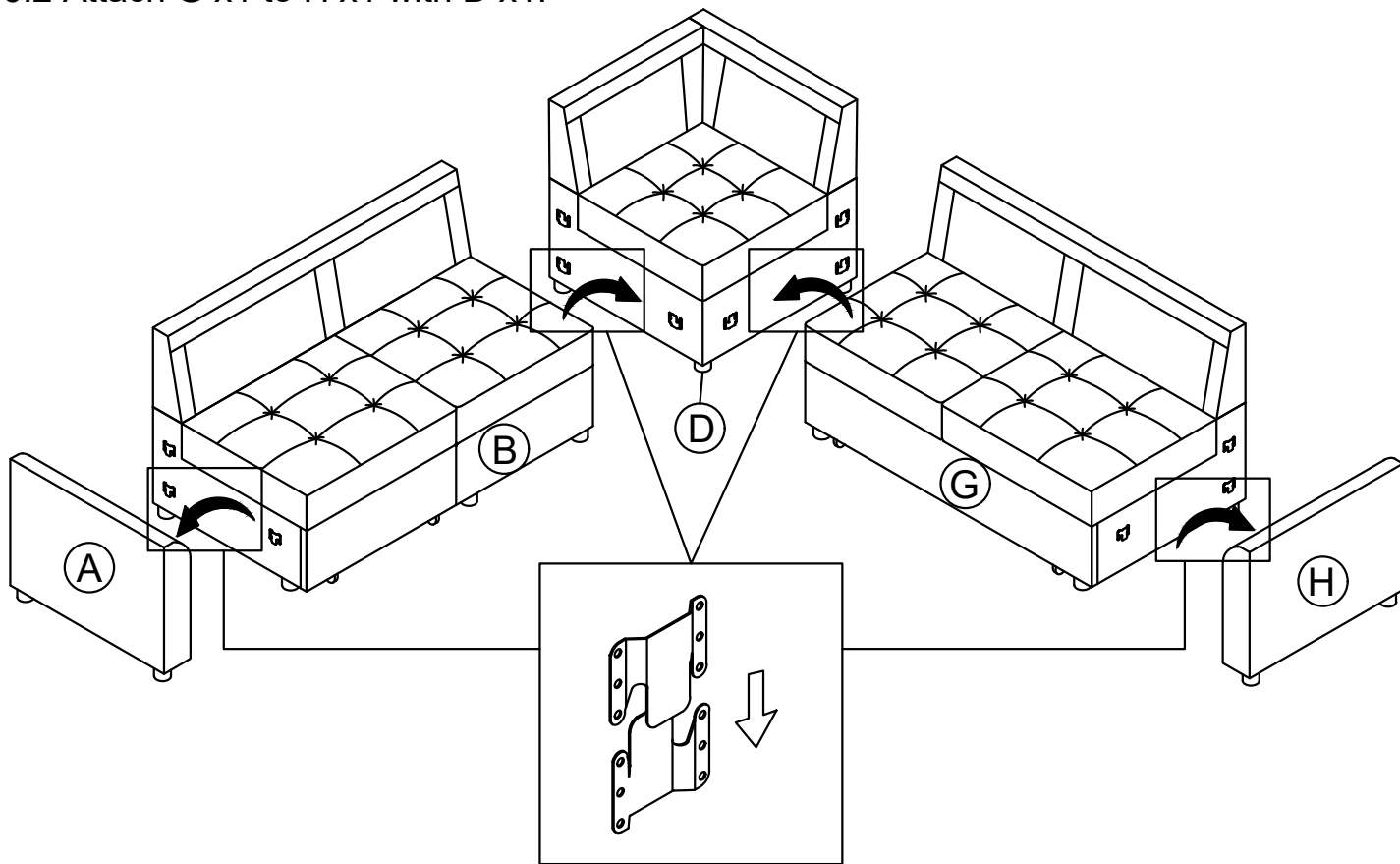

STEP 7:

- 7.1 Attach K x4 to C x1 with J x1
- 7.2 Attach L x1 to E & M with F.

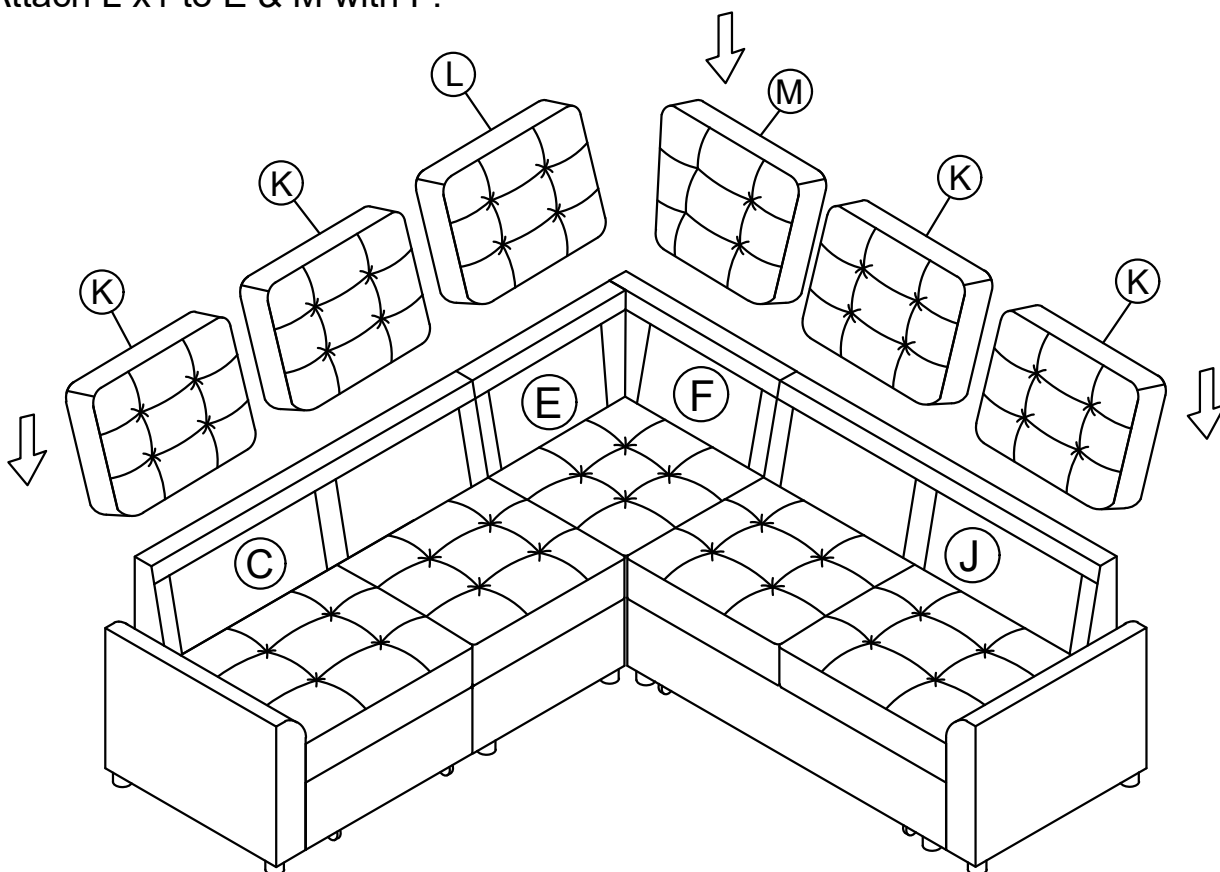

STEP 8:

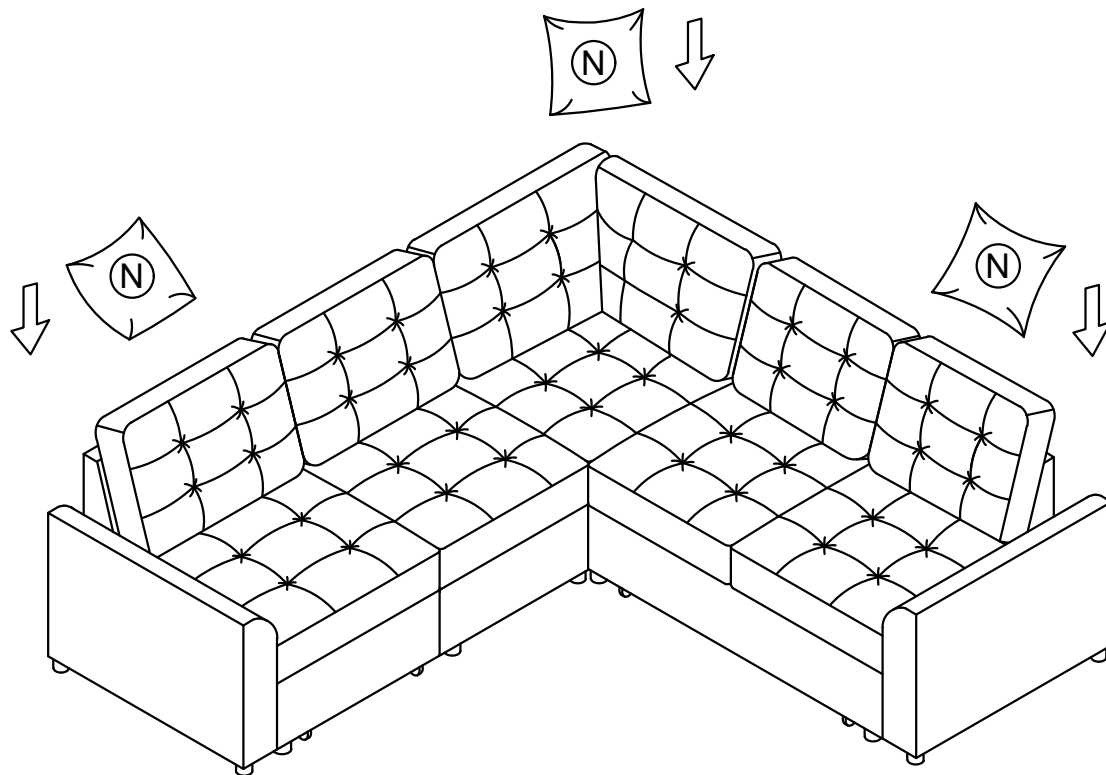

Helpful Hints

- Sectional sofa can transform into a sleeper
- Move your new furniture carefully, with two people lifting and carrying the unit to its new location.
- Your furniture can be disassembled and reassembled to move.
- Clean the product with a soft damp cloth. DO NOT use harsh chemicals or abrasive cleaners.

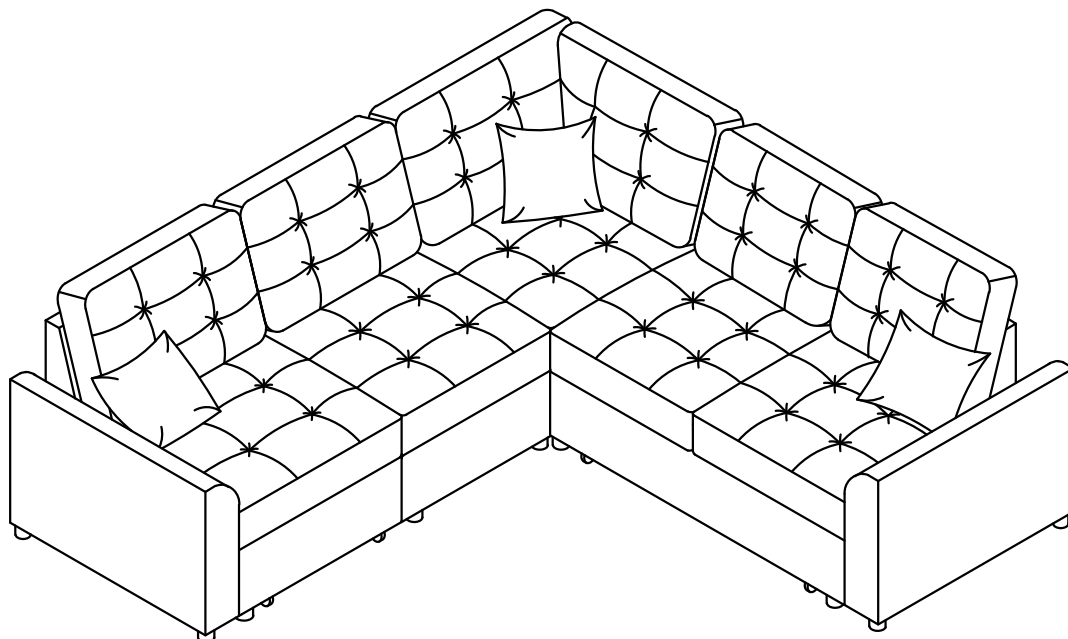

COMPLETE

