

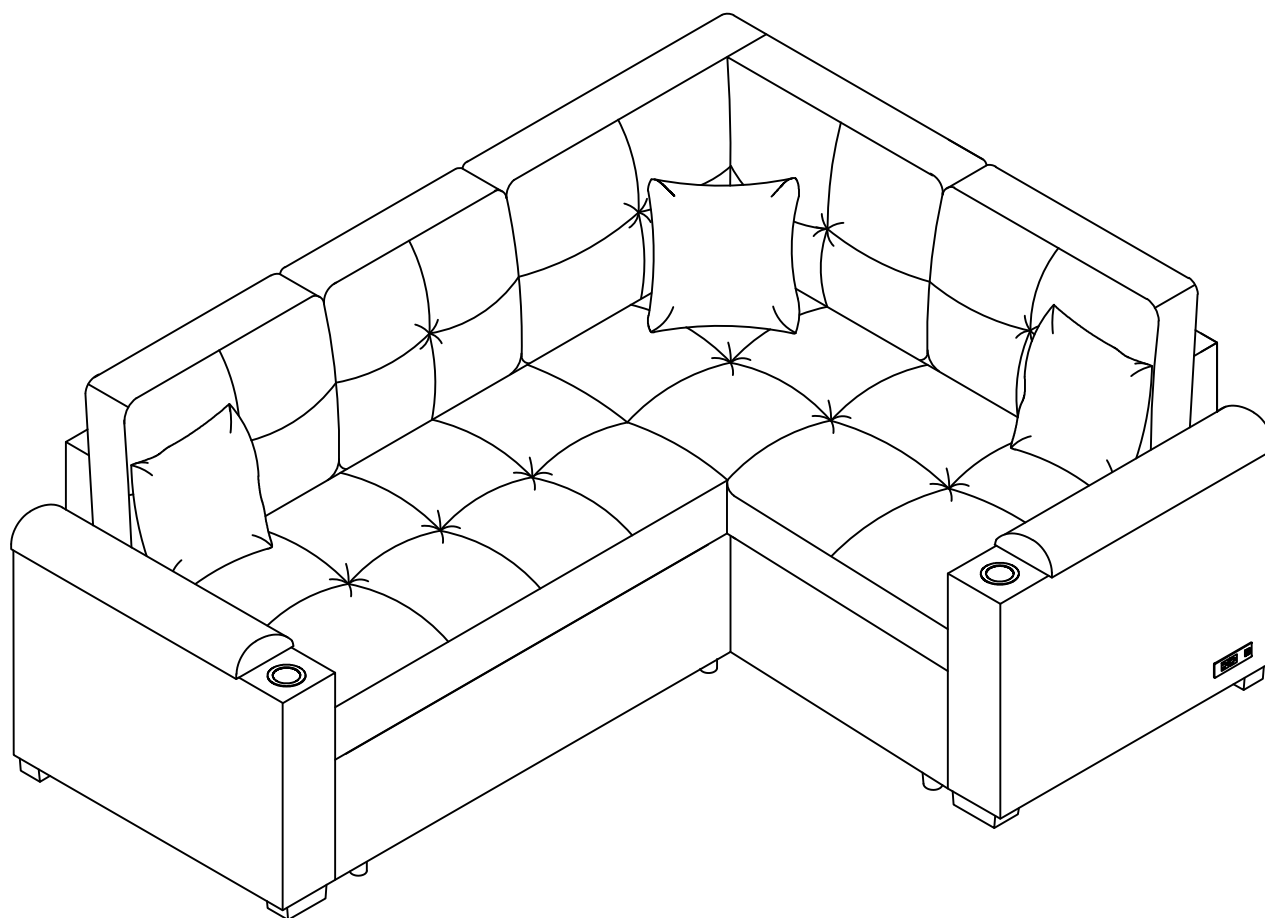

# ASSEMBLY INSTRUCTION

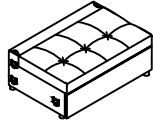





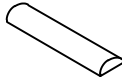



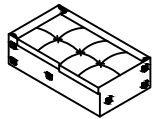

ITEM NO.: WF314536-WF314537-WF314538





**WF314537-COMPONENT LIST**

NO.	DRAWING	QTY	DESCRIPTION
B		1	Loveseat Body
J		2	Pillows
H		2	Loveseat Back Cushion
O		2	Topper of Arms

**WF314536-COMPONENT LIST**

NO.	DRAWING	QTY	DESCRIPTION
D		1	Chaise Body
C		1	Loveseat Backrest
E		1	Short Backrest
F		1	Chaise Backrest
I		1	Short Back Cushion
K		1	Long Back Cushion
H		1	Loveseat Back Cushion
L		4	Legs
J		1	Pillows
M		4	Arm Legs
N		8	Bolt
P		1	Allen key

**WF314538-COMPONENT LIST**

A		1	Left Arm
G		1	Right Arm

# PARTS LIST

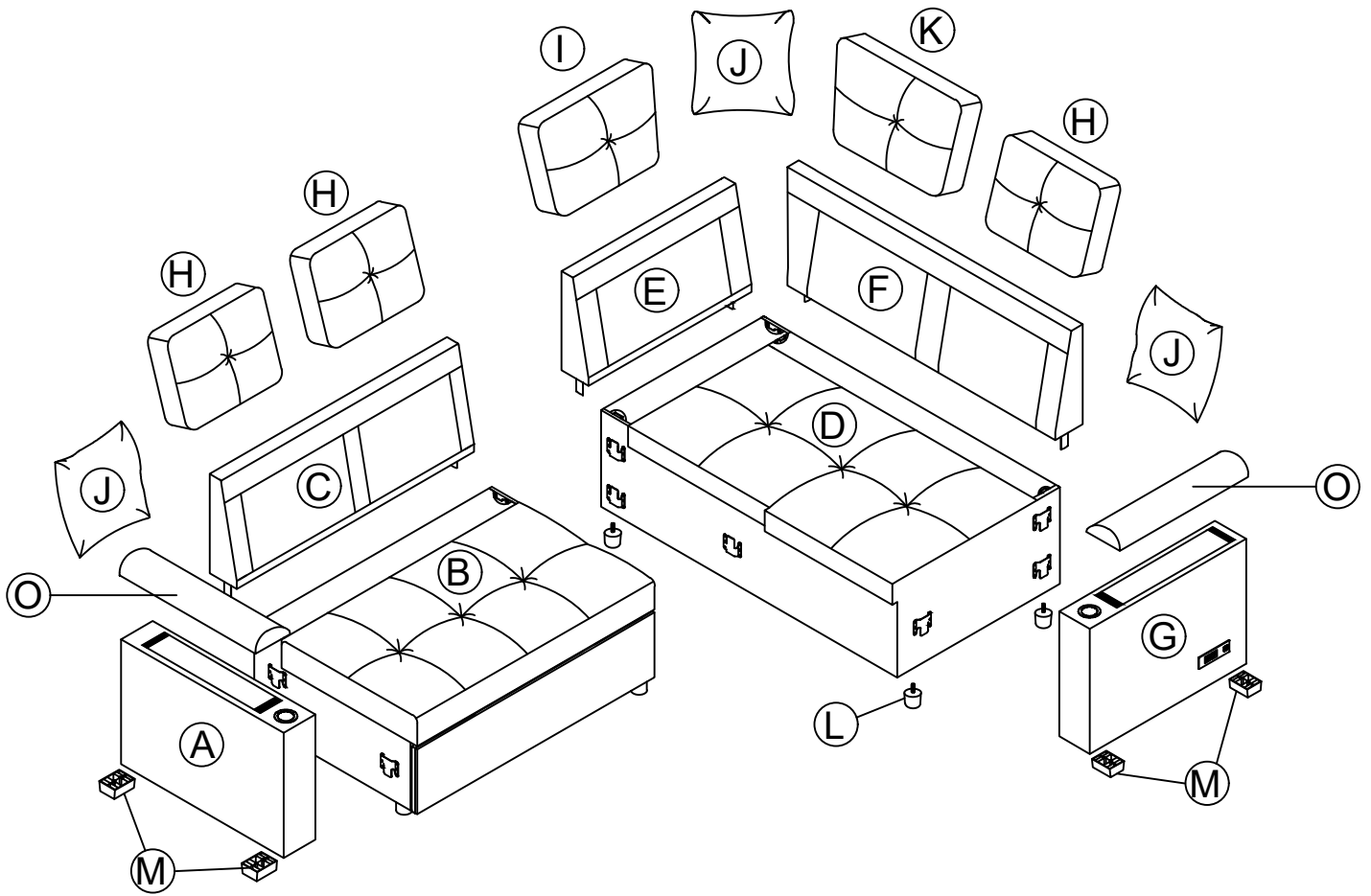

(A)

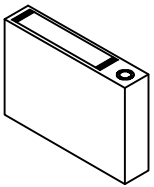

Left Arm  
X 1PC

(B)

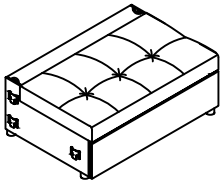

Loveseat Body  
X 1PC

(C)

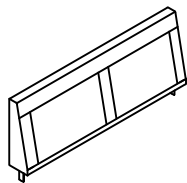

Loveseat Back Frame  
X 1PC

(D)

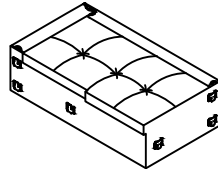

Chair Body  
X 1PC

(E)

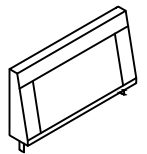

Short Back Frame  
X 1PC

(F)

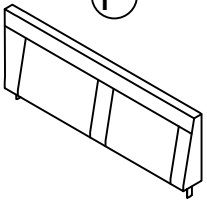

Chair Back Frame  
X 1PC

(G)

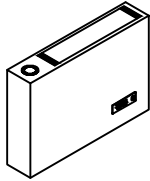

Right Arm  
X 1PC

(J)

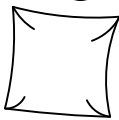

Pillows  
X 3PCS

(H)

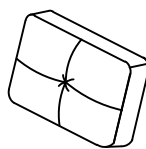

Loveseat Back Cushion  
X 3PCS

(I)

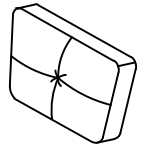

Short Back Cushion  
X 1PC

(K)

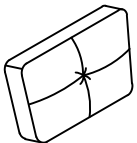

Long Back Cushion  
X 1PC

(L)

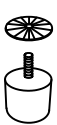

Legs  
X 4PCS

(M)

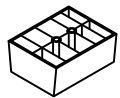

Square Leg  
X 4PCS

(N)



Bolt 5/16"X50mm  
X 8PCS

(P)



Allen key  
1PC

(O)

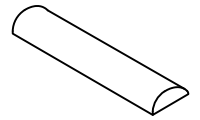

Topper of Arms  
2PCS

**STEP 1:**

- 1.1 Attach M x2 with N x4 to A x1
- 1.2 Attach M x2 with N x4 to G x1.
- 1.3 Attach O x2 to Ax1 and G x1.

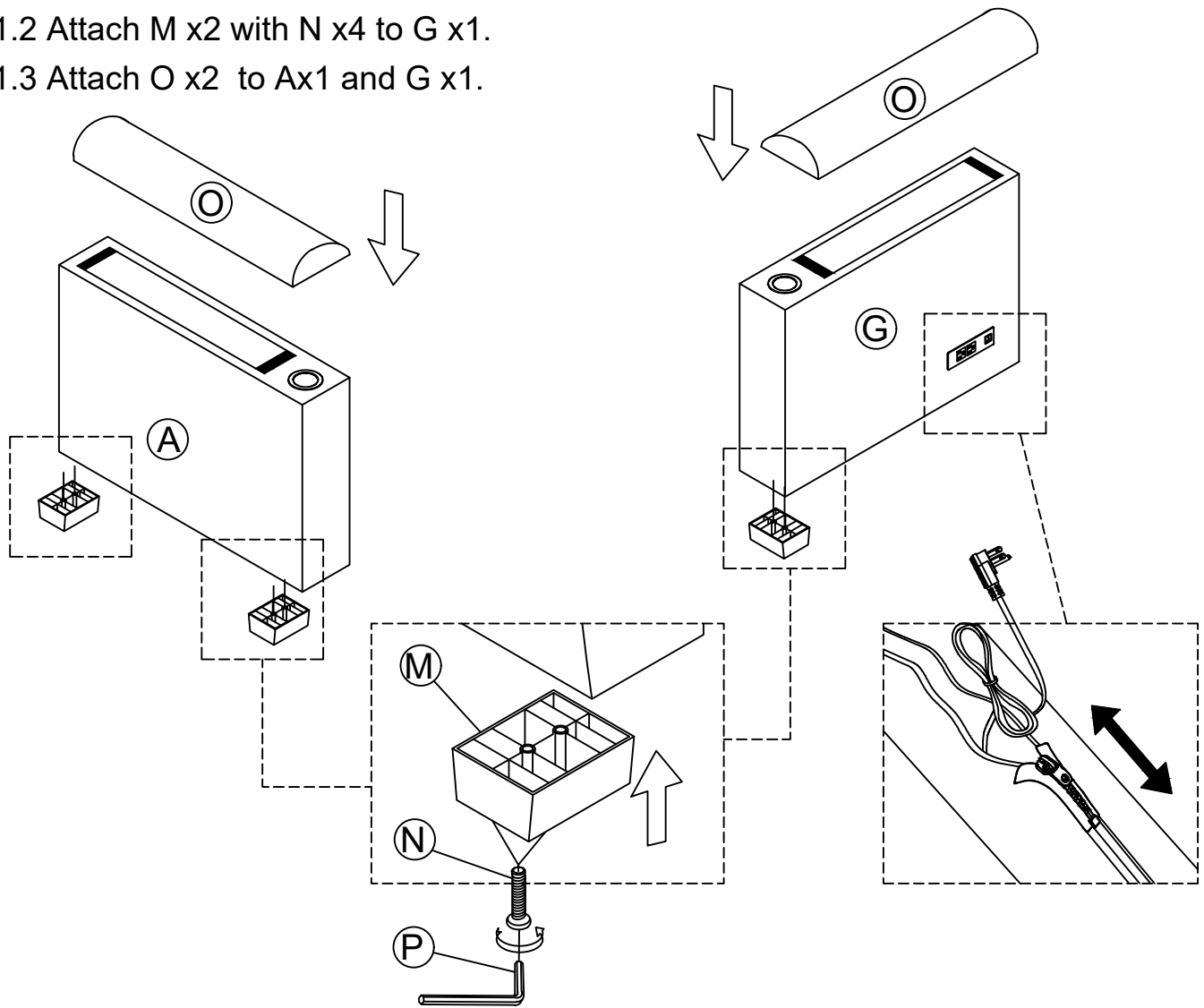

**STEP 2:**

- 2.1 Attach L x4 to D x1.

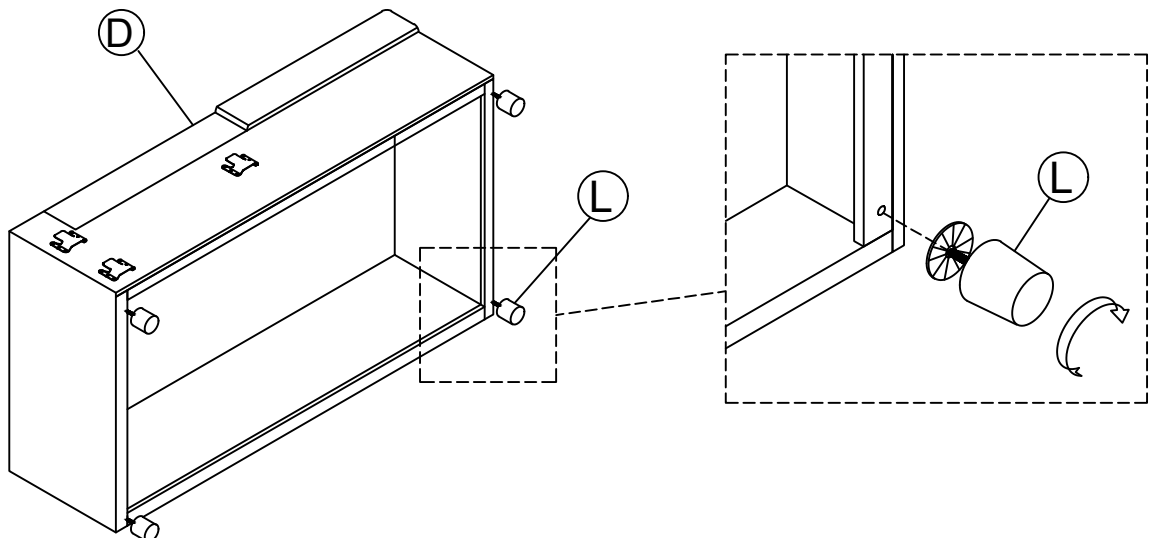

**STEP 3:**

- 3.1 Attach B x1 to A x1
- 3.2 Attach D x1 to G x1
- 3.3 Attach B x1 to D x1.

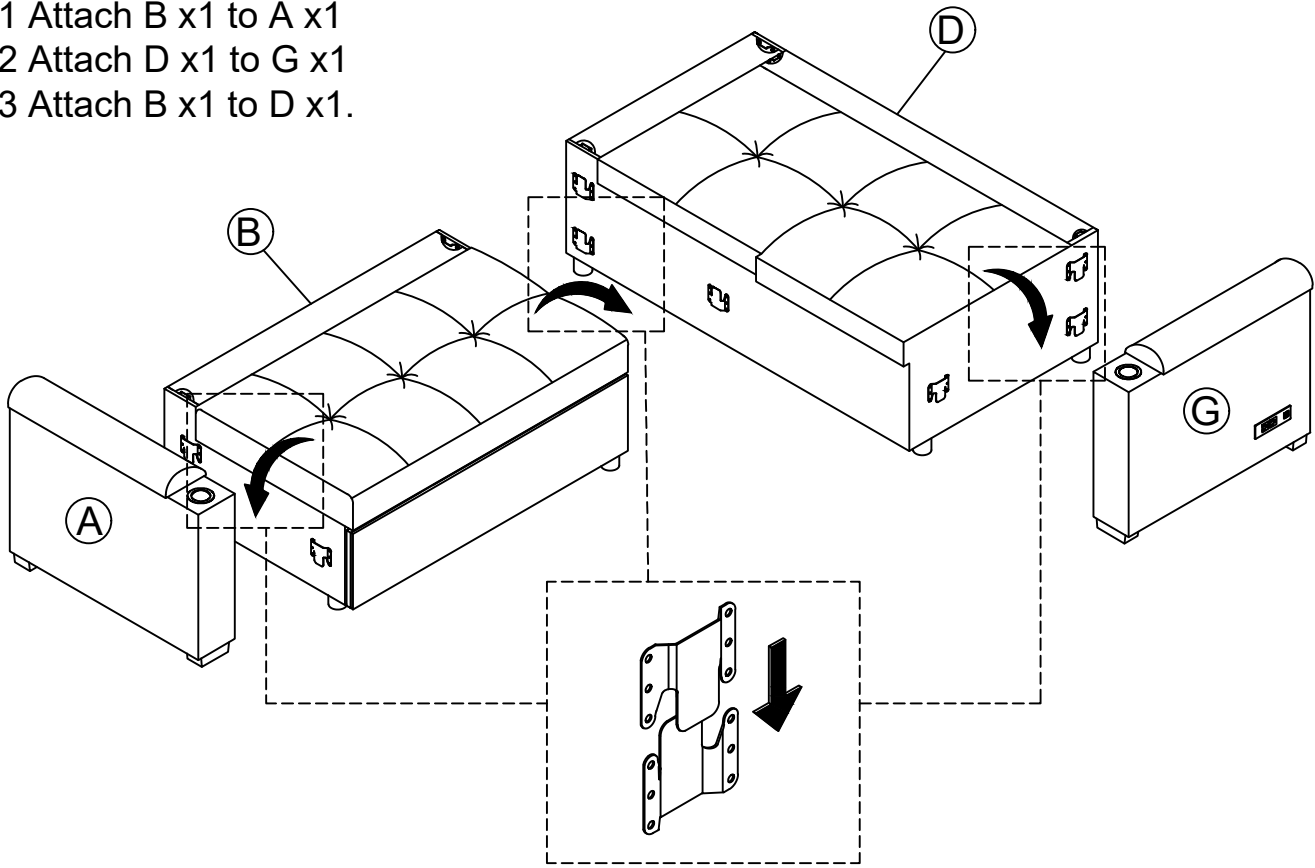

**STEP 4:**

- 4.1 Attach C x1 to B x1
- 4.2 Attach E x1 with F x1 to D x1 .

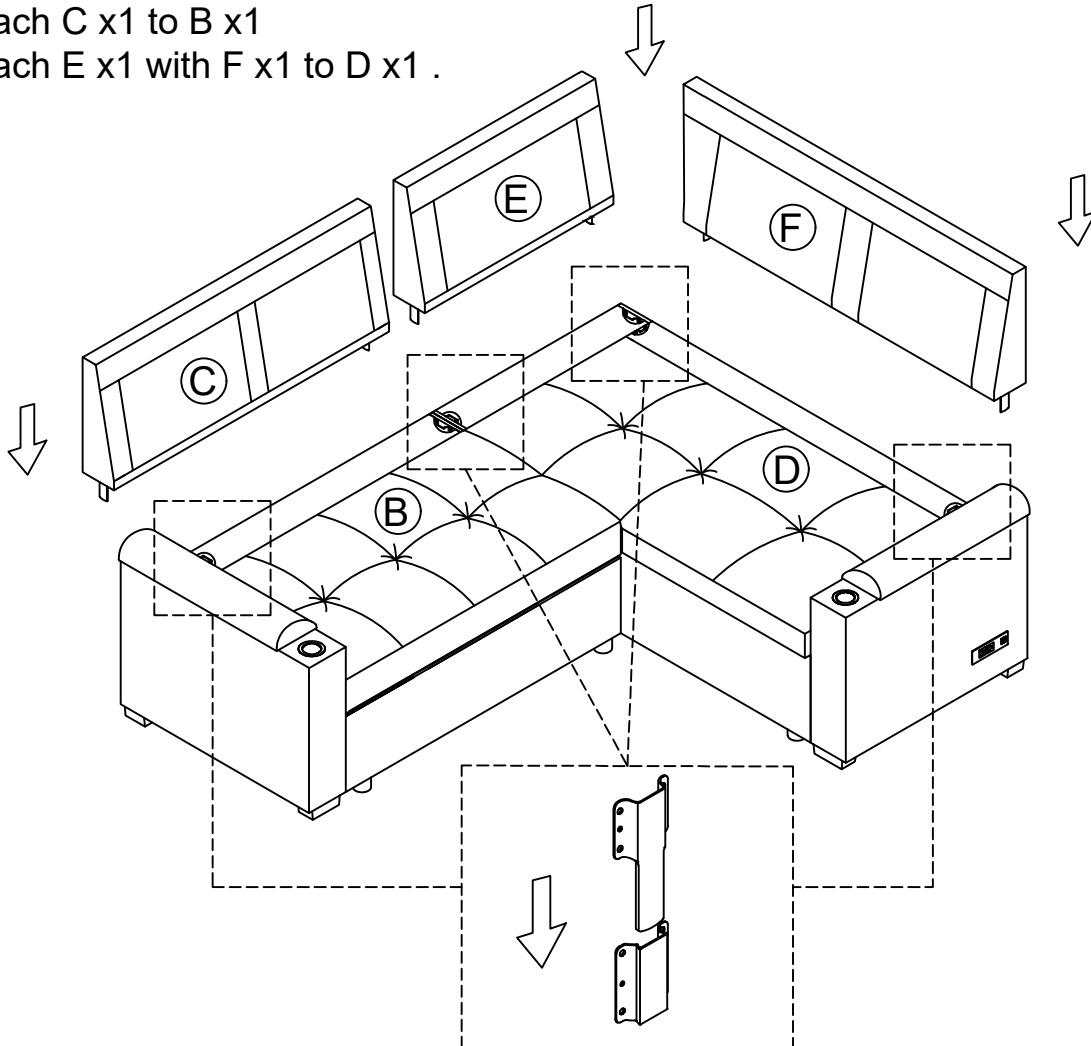

## STEP 5:

5.1 Attach H x2 to C x1

5.2 Attach I x1 to E x1

5.3 Attach K x1 with Hx1 to F x1.

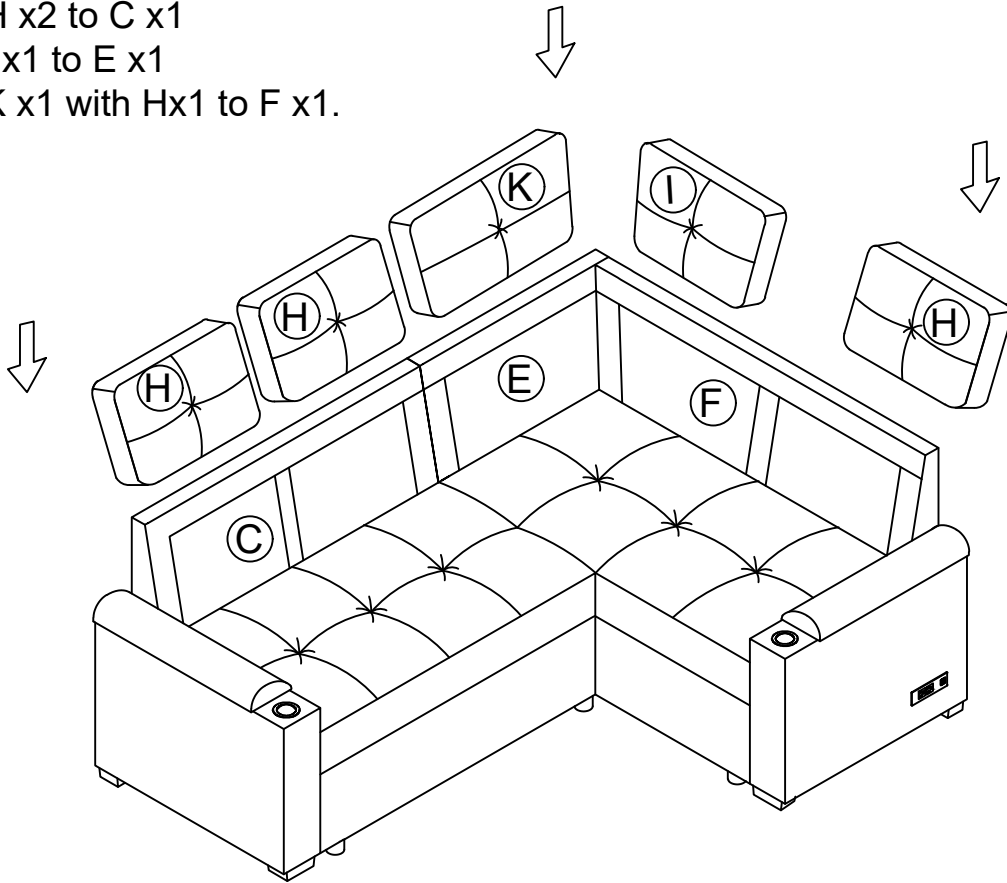

## STEP 6:

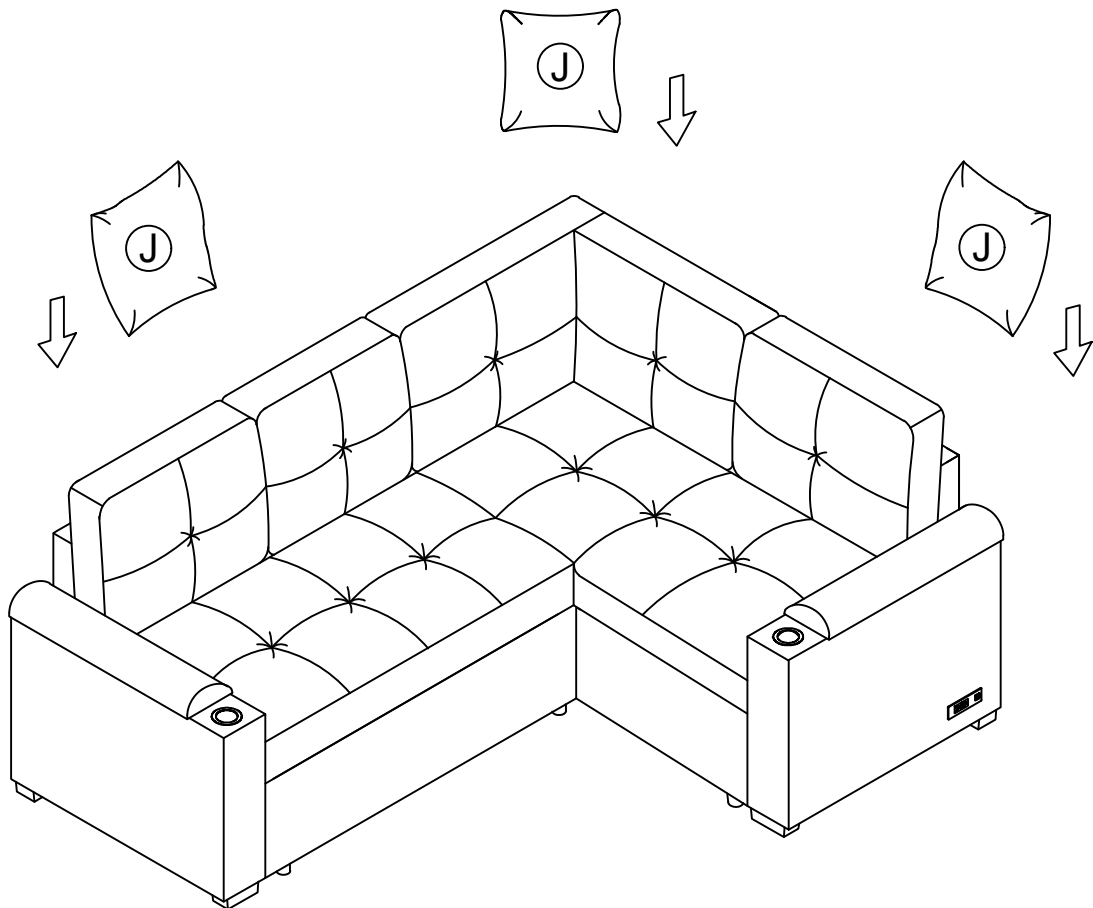

# Helpful Hints

- Sectional sofa can transform into a sleeper
- Move your new furniture carefully, with two people lifting and carrying the unit to its new location.
- Your furniture can be disassembled and reassembled to move.
- Clean the product with a soft damp cloth. DO NOT use harsh chemicals or abrasive cleaners.

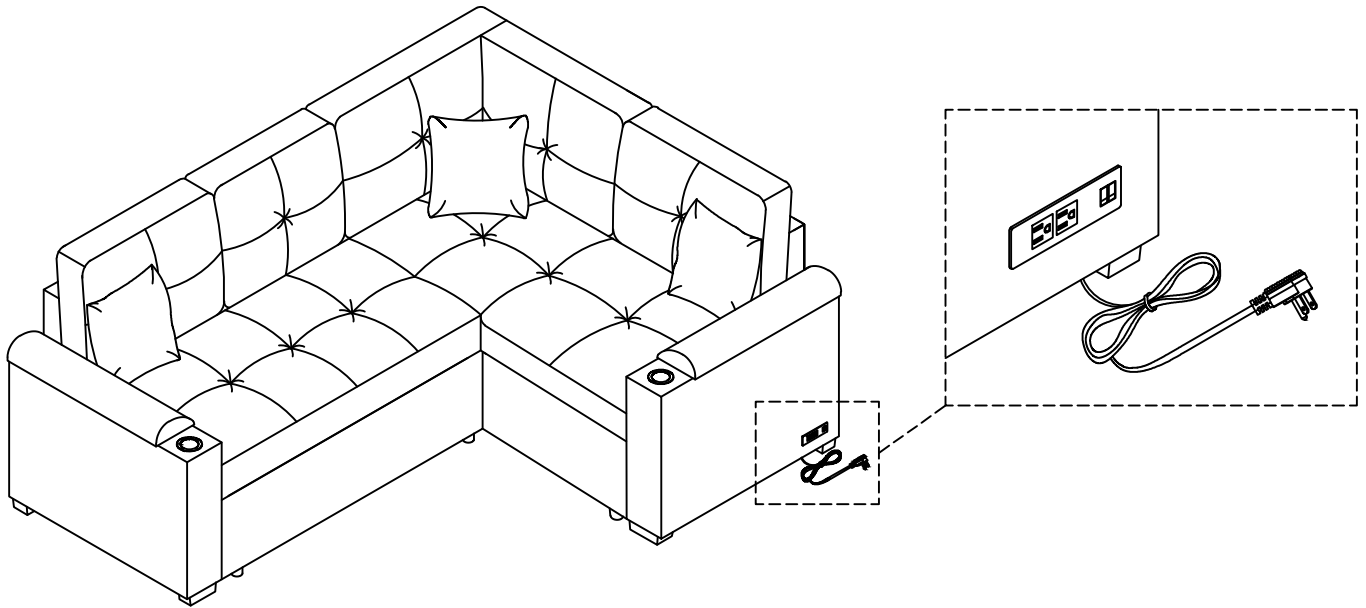

## COMPLETE

