

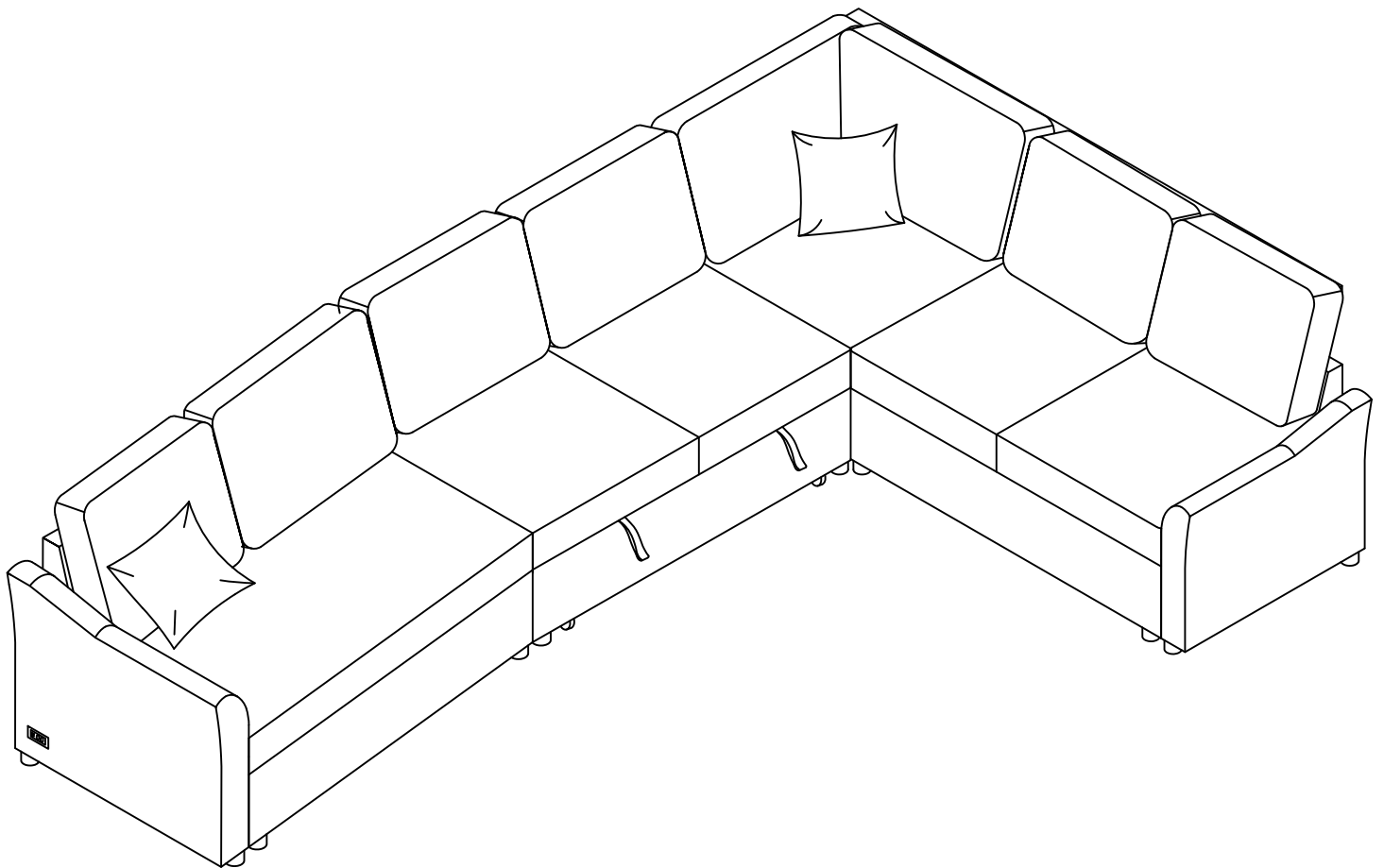







ASSEMBLY INSTRUCTION





ITEM NO.: WF324139 -WF324140-WF324141









WF324139-COMPONENT LIST

A		1	Corner Body
K		1	Long Corner Back Cushion
L		1	Short Corner Back Cushion
M		1	Biggest Back Cushion
E		1	Long Corner Backrest
I		1	Short Corner Backrest
B		8	Round legs
P		1	Loveseat Body

WF324140-COMPONENT LIST

J		2	Loveseat Backrest
O		1	Arm
B		6	Round legs
D		1	Loveseat Body

WF324141-COMPONENT LIST

F		5	Back Cushion
N		2	Pillows
H		1	Loveseat Backrest
C		1	Arm(USB)
B		6	Round legs
G		1	Loveseat Body

PARTS LIST

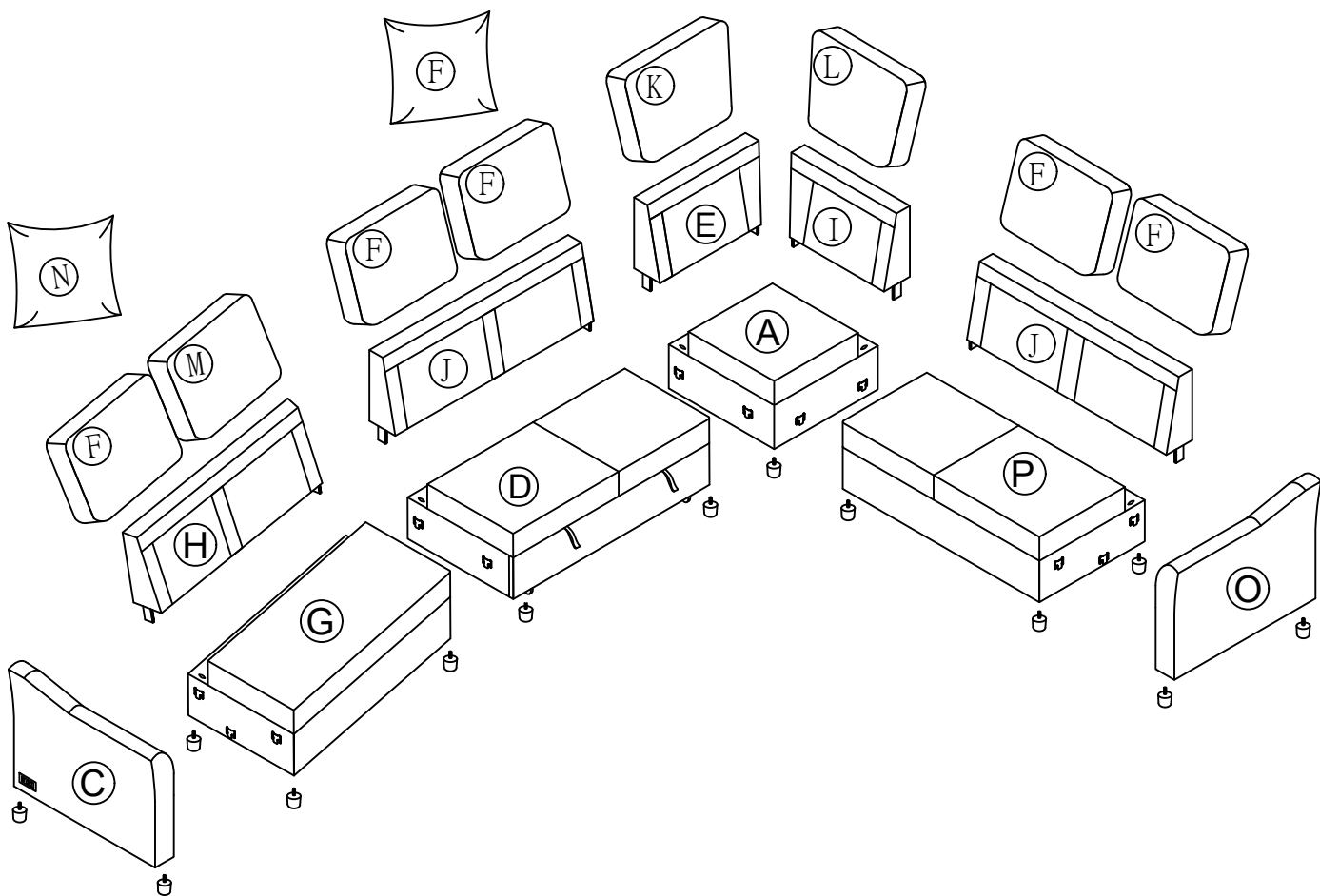

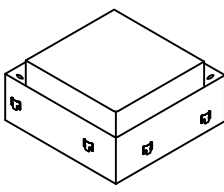
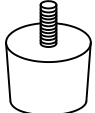
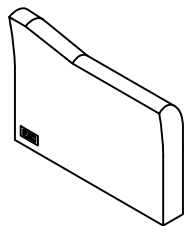
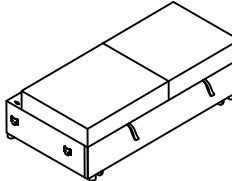
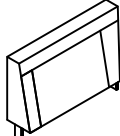
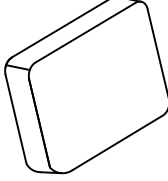
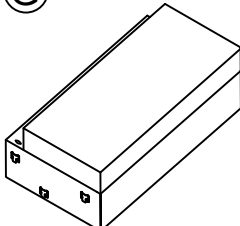
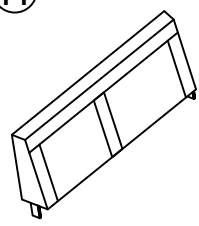
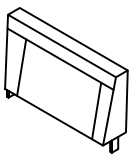
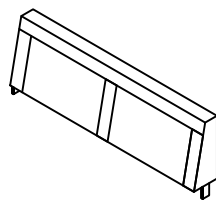
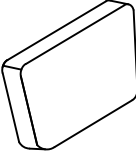
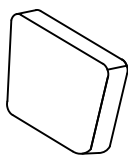
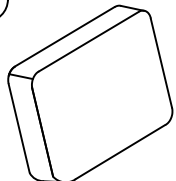
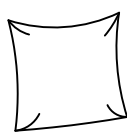
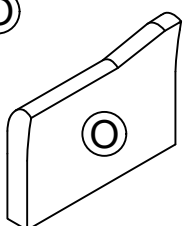
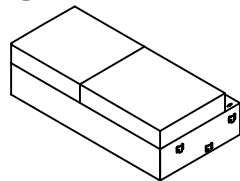
					
<p>Corner Body X 1PC</p>	<p>Round legs X 20PCS</p>	<p>Arm(USB) X 1PC</p>	<p>Loveseat Body X 1PC</p>	<p>Long Corner Backrest X 1PC</p>	<p>Back Cushion X 5PCS</p>
					
<p>Loveseat Body X 1PC</p>	<p>Loveseat Backrest X 1PC</p>	<p>Short Corner Backrest X 1PC</p>	<p>Loveseat Backrest X 2PCS</p>	<p>Long Corner Back Cushion X 1PC</p>	<p>Short Corner Back Cushion X 1PC</p>
					
<p>Biggest Back Cushion X 1PC</p>	<p>Pillows X 2PCS</p>	<p>Arm X 1PC</p>	<p>Loveseat Body X 1PC</p>		<p>Page 3 of 5</p>

STEP 1:

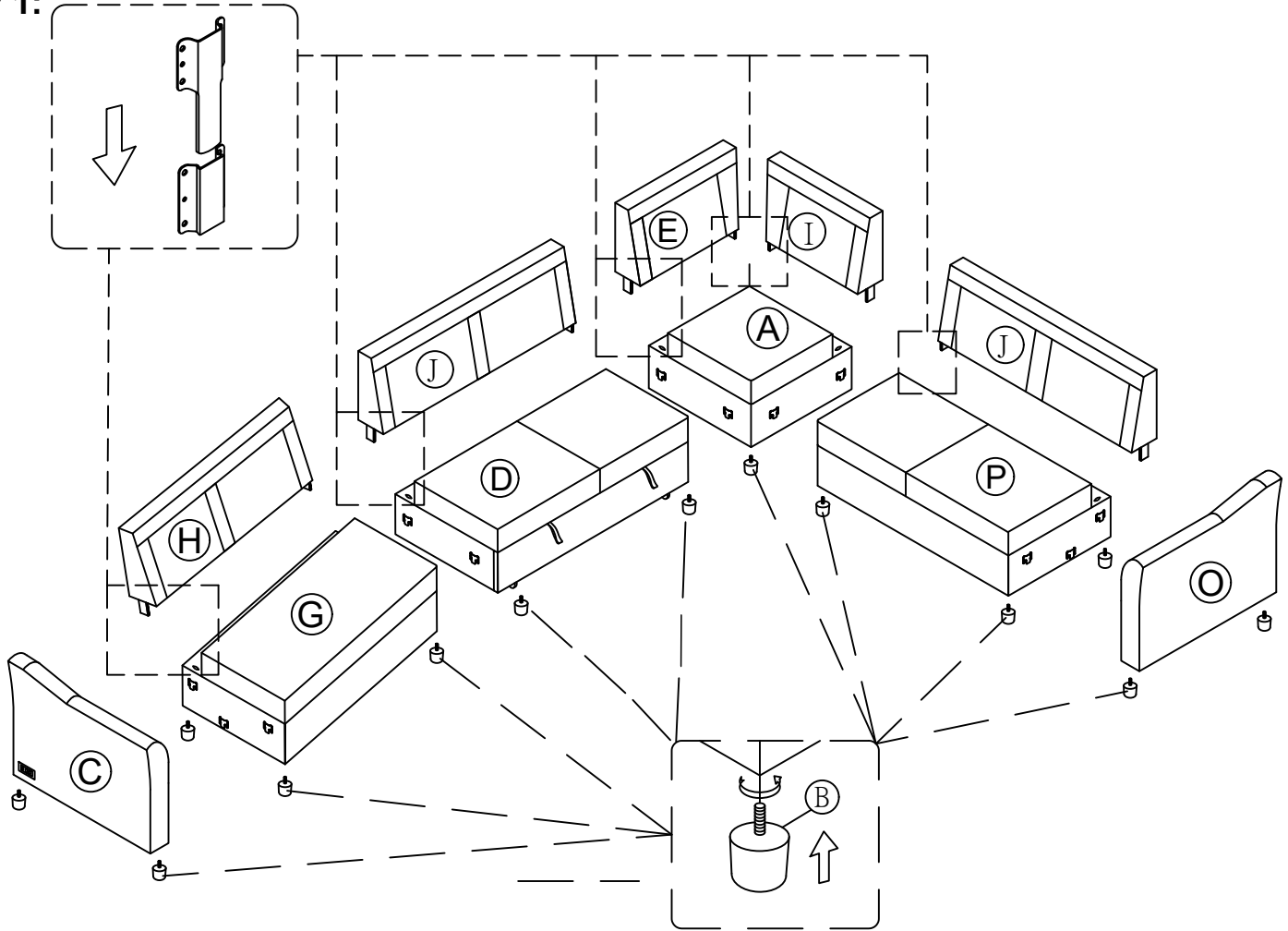

STEP 2:

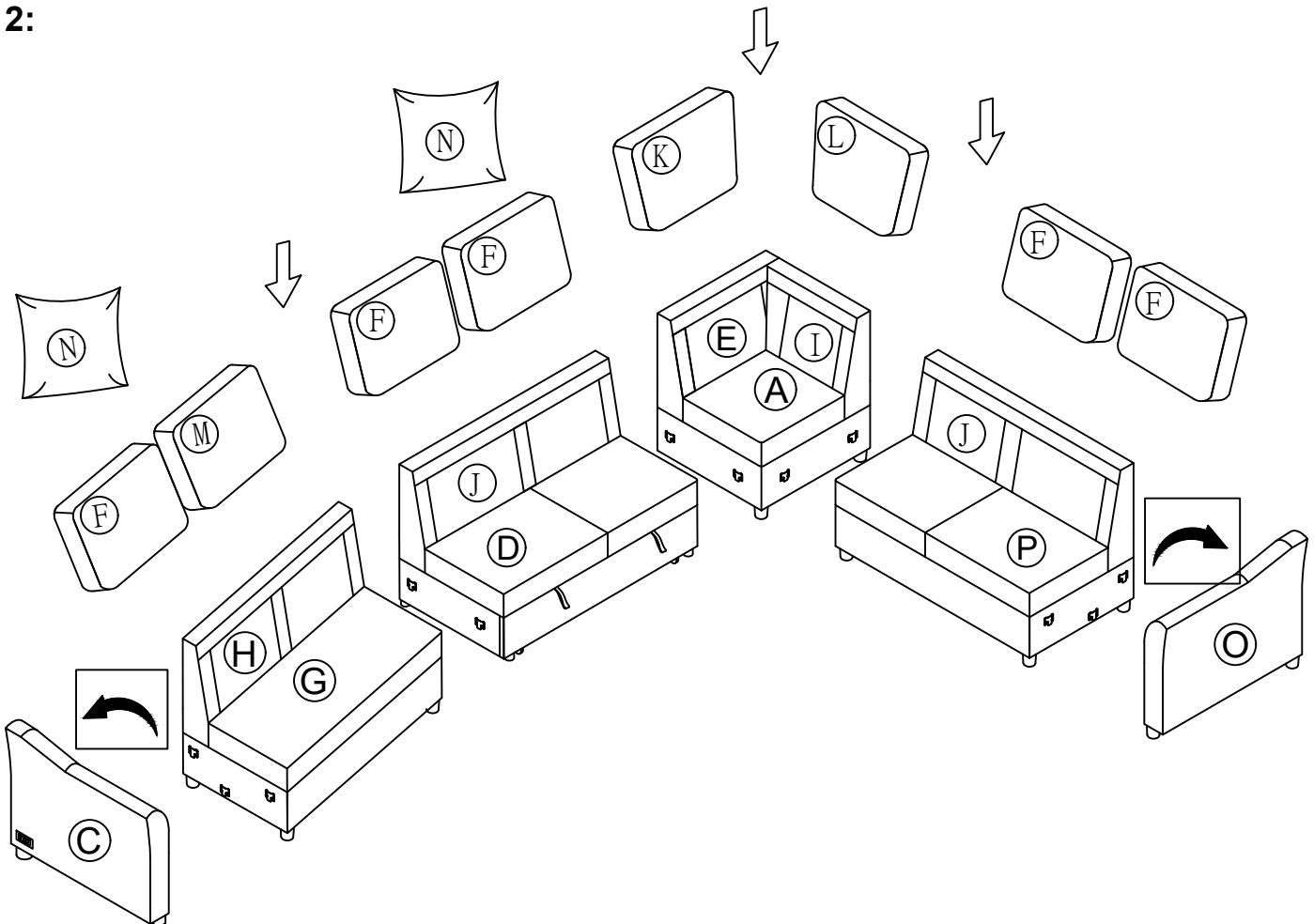

Helpful Hints

- Sectional sofa can transform into a sleeper
- Move your new furniture carefully, with two people lifting and carrying the unit to its new location.
- Your furniture can be disassembled and reassembled to move.
- Clean the product with a soft damp cloth. **DO NOT** use harsh chemicals or abrasive cleaners.

COMPLETED

