

ASSEMBLY INSTRUCTION

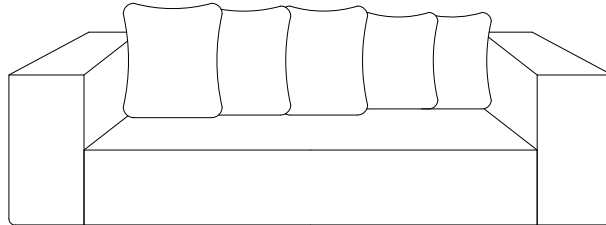

Return & Warranty policy:

--We strive to offer the highest quality products, and we also try our best to satisfy each and every customer that orders from us with replacement parts/or service as needed.

--If the item is damaged or defective, please take photos as evidence for replacements and refunds.

--Please do not return to store, contact the seller if you have any trouble with this product.

TIPS

1. Due to differences of light effects, the actual color of the materials might be slightly different from the pictures.
2. No Assembly Required. This sofa can free of your stereotyped nightmare of furniture assembly.
3. Due to package compression for better shipment, the fabric may have wrinkles.
4. Please take all packages out and pat every part to make it rebound better and fluffy, so that it can restore to picture-like status.
5. Please keep children away from the plastic bags.

ASSEMBLY INSTRUCTION

STEP 1

Take out the sofa body and cushions from box

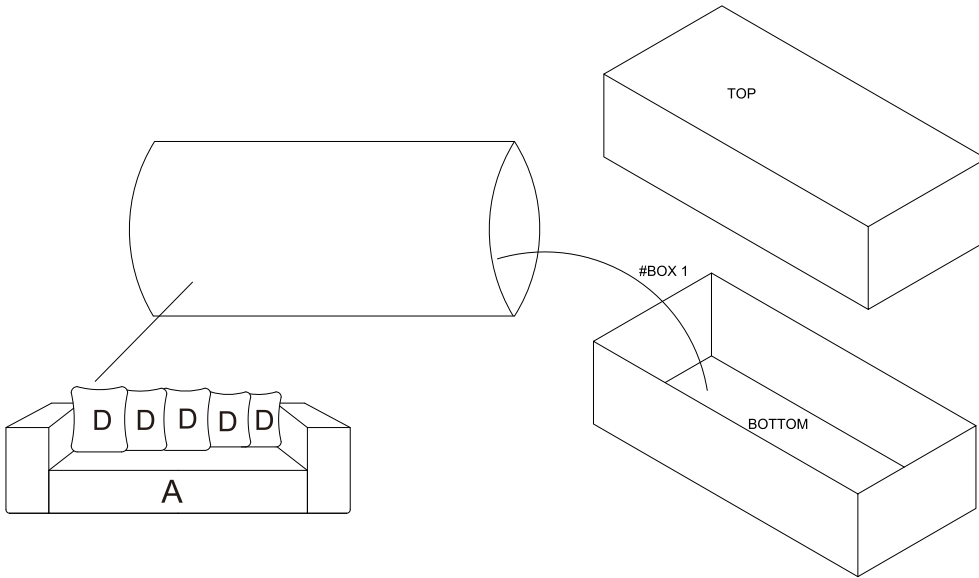

STEP 2

Open the first layer of package

Attention:

The first layer of packages one and two can be opened without the need for sharp tools!

Find the connection point on the package and pull it open to open the first layer of packaging.

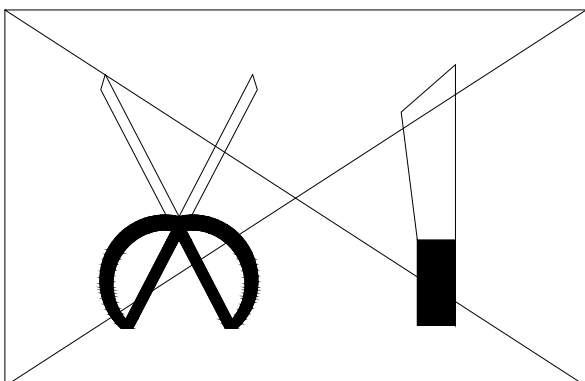
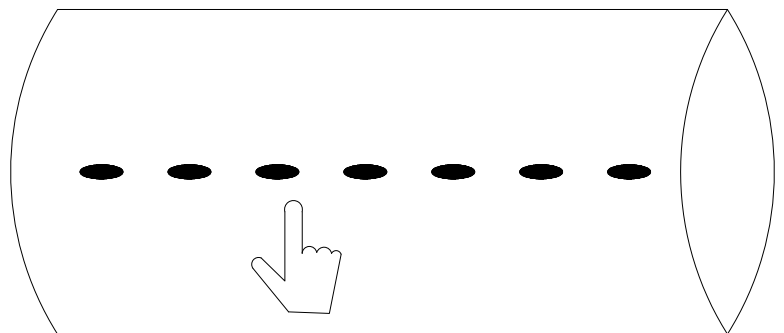

ASSEMBLY INSTRUCTION

STEP 3

Open the second layer of package

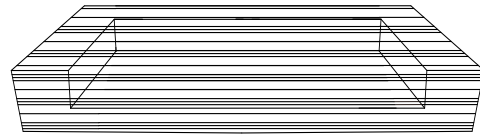
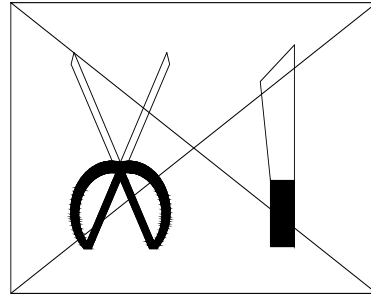
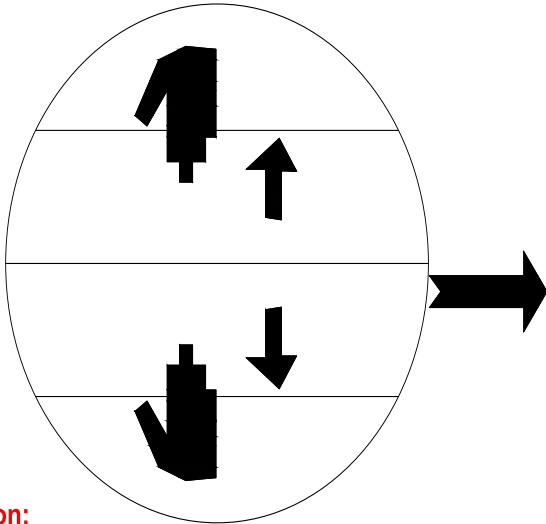

Attention:

1. After opening the first layer of package, you will receive the second layer of package, which becomes a flat rectangular package.
2. Please open the package from the second layer away from the sofa, do not scratch the sofa!
3. When opening the second layer of the package, the sofa will expand and return to its original state after about. **72 hours!**

STEP 4

Completed

