

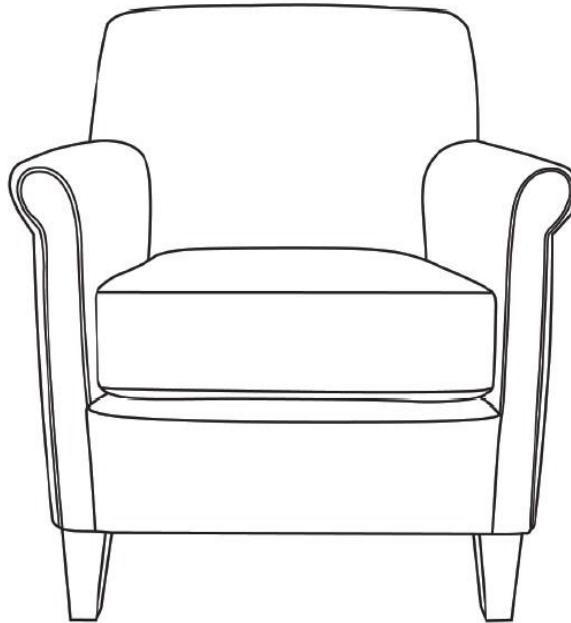

Assembly Instructions

Caution : You must read this before you proceed

Club Chair



Parts List

Label	Picture	Description	QTY
A		Chair	1
B		Leg	4

Hardware

Label	Picture	Description	QTY
①		Washer Rings	7

Assembly Preparation

Before
Beginning
Assembly:

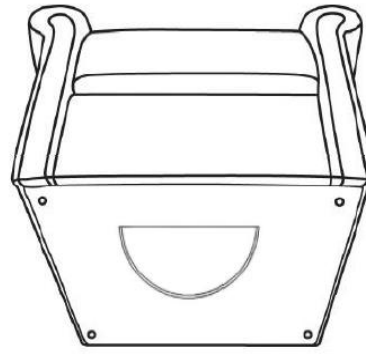

- Read instructions, cover to cover-



- Have 2 adults on hand for assembly-



- Do not assemble on flooring or carpet-



- Assemble on a clean non-marring surface (packing foam)-



- Save all packaging until finished-

Assembly Steps

Overview

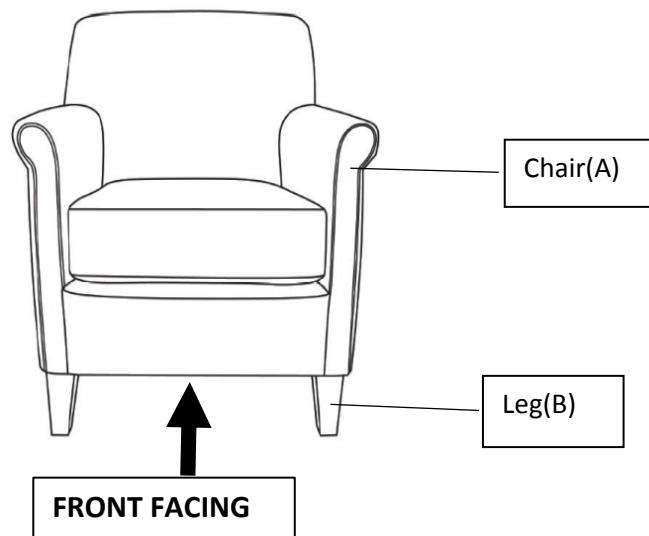

This Club Chair has multiple parts and may require up to some 30 minutes to assemble. To give you an overview of the Club Chair parts, the above picture is to help you put the various parts into perspective. Please read through the instructions below to familiarise yourself with the parts and steps before assembly.

Step 1



Position the chair on its back, as shown on a clean, non-marring surface.
Unzip to open pouch and remove the 4 wooden legs, close the pouch.

Step 2

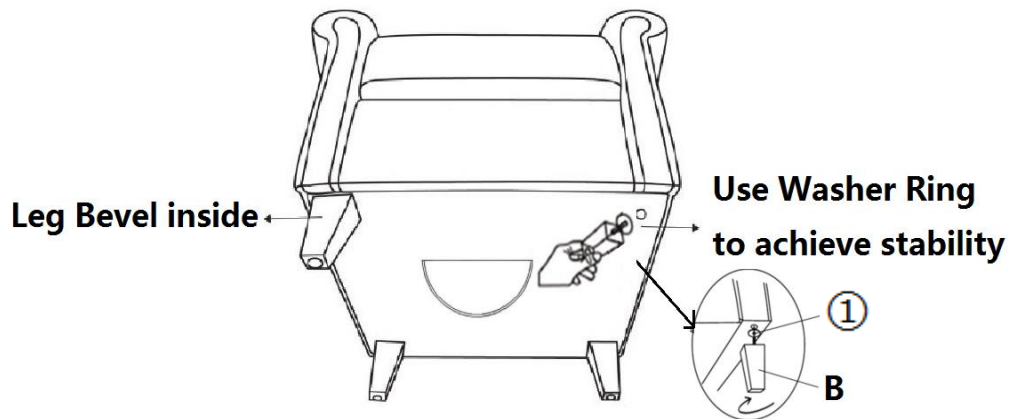

Install Leg(B) into the Chair(A) by putting a Washer Ring (①) on the threaded Stem and then Insert the threaded Stem into the mounting position at each Corner of the Bottom of the Chair(A).

Tighten by turning Leg clockwise.

Repeat the same Step to install the other three Legs(B).

When assembling the Legs, two Slant-Angled sides of Leg(B) must be affixed to be inward Facing.

This is the same Position for both the FRONT and BACK pair for both LEFT and RIGHT Legs.

Note: The use of Gaskets are OPTIONAL and are especially useful to help alleviate slight wobbleness. Some Legs may need more than one gasket whilst some legs may not need any.

Step 3

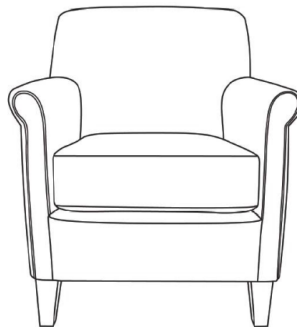





















Make sure all parts are connected and locked into position.

Stand the Chair right side up.

Your chair is ready for use.

Caution: This Chair can only be used on a flat, level surface.

Care & Maintenance

-   ● Do not put hot items directly on furniture surface
 -   ● Do not clean furniture with harsh cleansers or polish.
 -   ● Do not place furniture under direct sunlight.
 -   ● Do not place furniture near heating or cooling vents.
 -   ● Do not write on furniture without a padded barrier to protect the surface.
 -   ● Do not place furniture outside . For indoor use only .
 -   ● Not for commercial use. For residential use only .
 -   ● Stains may be removed with mild soap solution and damp cloth.
 -   ● Children should not climb or jump on the furniture.
-
-   ● Dust and pick-up spills using a clean, non-colored, lint-free cloth .

What is Proposition 65?

Proposition 65 is a California law that requires warning labels on products that may contain one of more than 800-plus chemicals or ingredients that the California Office of Environmental Health Hazard Assessment (OEHHA) has deemed to cause cancer or other reproductive toxicity. Chemicals and elements on this list include wood dust, brass, and other everyday substances, which can be found in very common household items, such as: lamps, tableware, jewelry, crystal glasses, electric cords, beauty products, automobiles, and furniture.

Why Did I Find a Proposition 65 Warning on My Home Goods Product?

We include Proposition 65 warnings on all of our products because there is always a chance that one of the 800-plus common chemicals and ingredients listed under this law could potentially be on our furniture or packing materials. We risk large fines under this law, if we don't include this warning.

Should I worry?

We realize you may be worried finding this warning on our products, but we want to reassure you that the hazardous exposure limits for any of these chemicals have never been found on furniture products that we've shipped to our customers. Additionally, this warning label is very common and can be found on almost every piece of furniture sold in the state of California.

Just How Common Are Proposition 65 Warnings?

Proposition 65 warnings have become so common in California that it is hard to take a trip to a local bank, grocery store, or restaurant without finding at least one warning. In fact, even the Disney Land Resort has a Proposition 65 warning:

