

ASSEMBLY INSTRUCTION

N723P167076/N723P167077 N723P167081/N723P167082
N723P167086 /N723P167087

Friendly Reminder:

- 1.This sofa is packed in 3 boxes. Please assemble it After all boxes are received.
- 2.As the cushions are all vacuum compressed,there will be some wrinkles. Please give your cushions up to 72 hours to reach its original size and the wrinkles will basically disappear.
- 3.Please do not open the compressed packages until your sofa frame is completely assembled

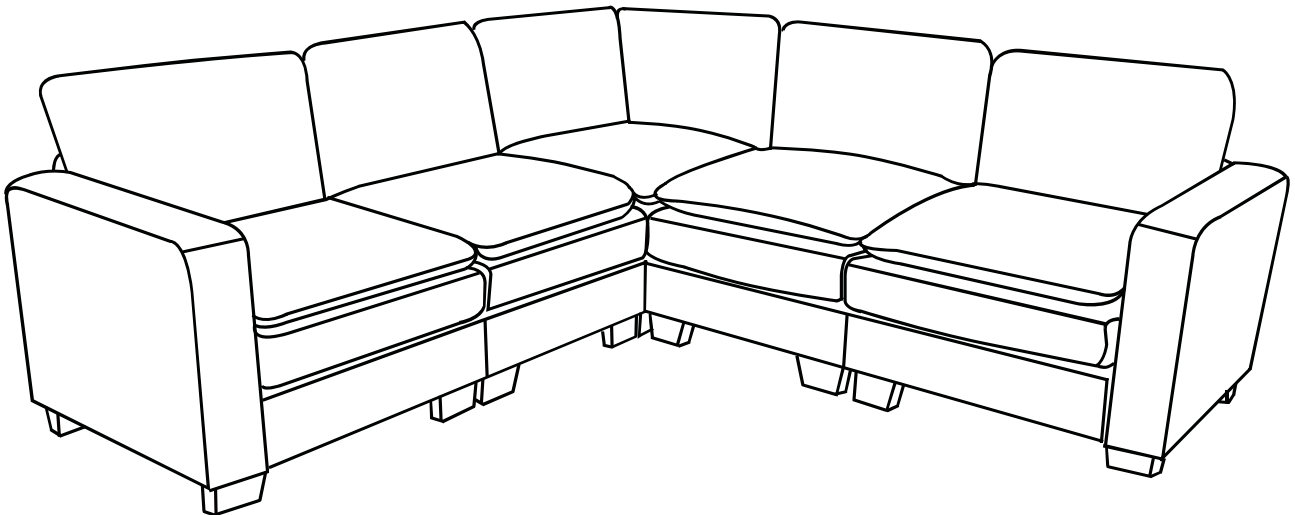





Return & Warranty policy:

- We strive to offer the highest quality products,and we also try our best to satisfy each and every customer that orders from us with replacement parts or service as needed.
- If the item is damaged or defective, please take photos as evidence for replacements and refunds.
- Please do not return to store,contact the seller if you have any troubles with this product.

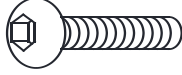
ASSEMBLY INSTRUCTION

HARDWARE

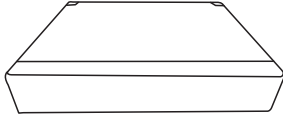
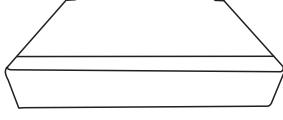
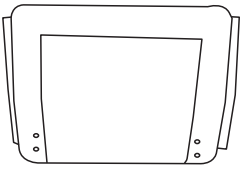
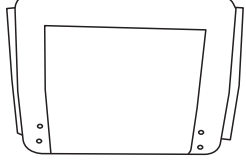
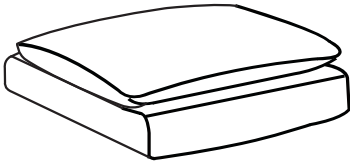
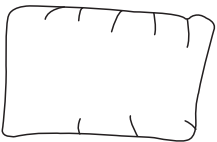

NO	DESCRIPTION	SKETCH	QTY
1	Screws 8X35		32
2	Screws 8X70		20
3	Washer		52
4	Wrench		1

PARTS LIST N723P167076&N723P167077



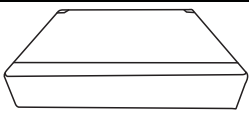
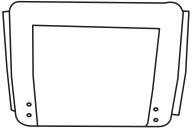
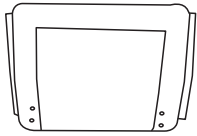
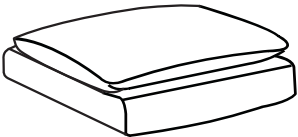

NO	DESCRIPTION	SKETCH	QTY
A	Seat frame (left)		1
B	Seat frame (right)		1
F	Back frame		2
G	Corner back frame		1
H	Seat cushion		2
J	Back cushion		2

ASSEMBLY INSTRUCTION

PARTS LIST N723P167081&N723P167082

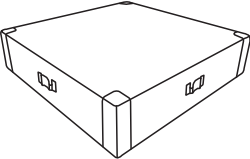
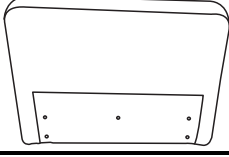
NO	DESCRIPTION	SKETCH	QTY
C	Middle seat frame		2
F	Back frame		2
G	Corner back frame		1
H	Seat cushion		2
J	Back cushion		2

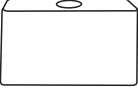
PARTS LIST N723P167086&N723P167087

NO	DESCRIPTION	SKETCH	QTY
D	Corner seat frame		1
E	Armrest		2
I	Corner seat cushion		1
K	Corner back cushion		2
L	Leg		20
M	Non-slip pad		40

All parts and hardwares

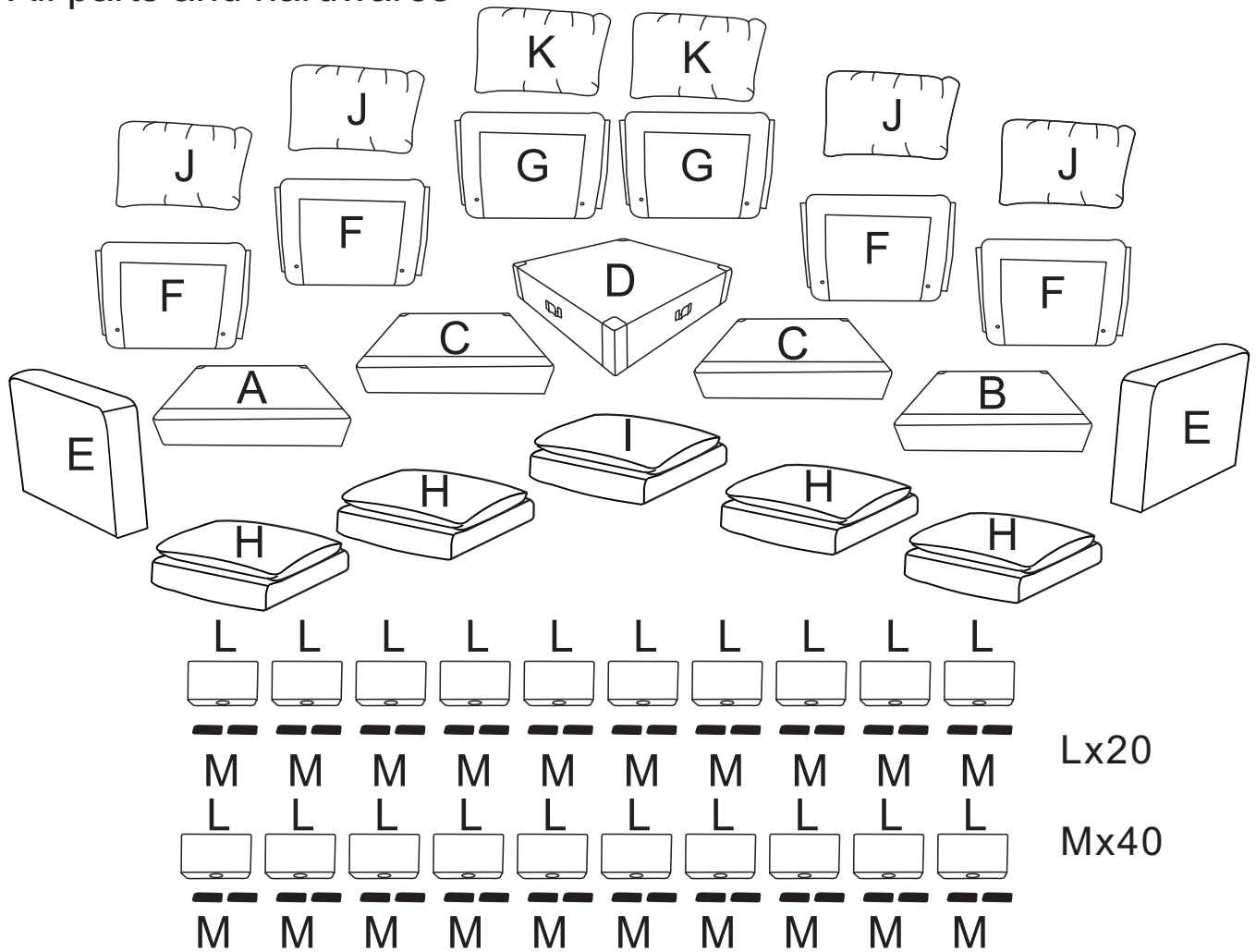
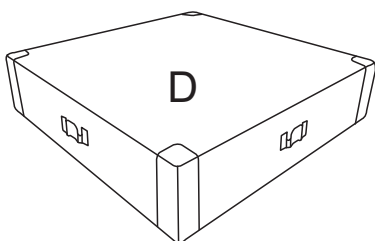

DIAGRAM1 (Take out all parts)

Take the Armrests(Part E) ,Corner back cushions(Part K), Corner seat cushion (Part I), Legs(Part L) ,Non-slip pad(Part M)out of the Corner seat frame(Part D).

Take the Back frames(Part F),Corner back frame(Part G),Seat cushions(Part H) , Back cushions(Part J)out of Seat frames(Part A&B).

Take the Back frames(Part F),Corner back frame(Part G),Seat cushions(Part H) , Back cushions(Part J)out of Middle seat frames(Part C).



E /K /I/ L/M

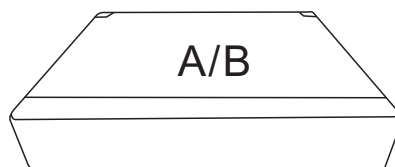

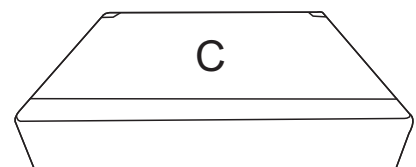

F/G/H/J



F/G/H/J

DIAGRAM 2 (Assemble the Armrest to the Seat frame)

Connect the Armrests(Part E) to the Seat frames(Part A&B) with the Screws M8X35mm (Hardware 1) and the Washers (Hardware 3) by Wrench (Hardware 4).

1		8PCS
3		8PCS
4		1PC

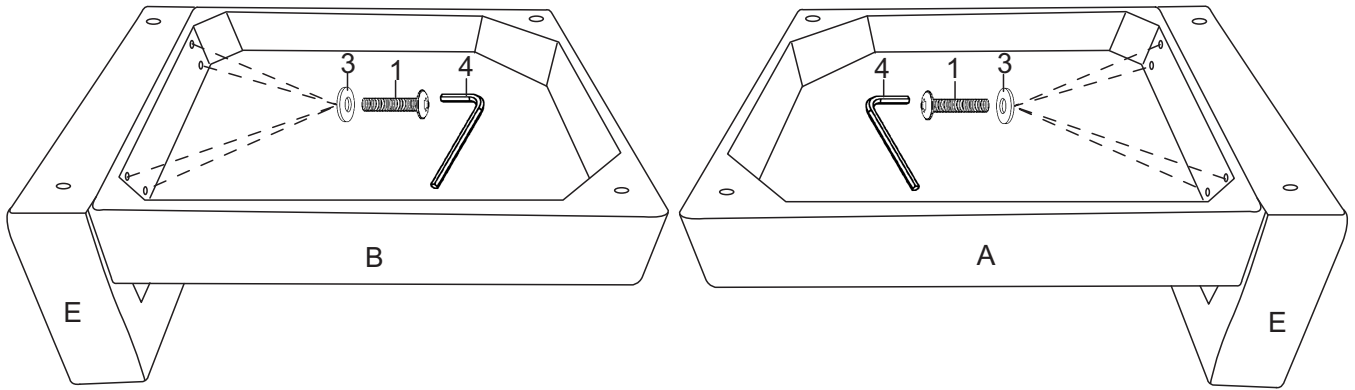







DIAGRAM3 (Assemble the Legs)

2		8PCS
3		8PCS
4		1PC
L		8PCS
M		16PCS

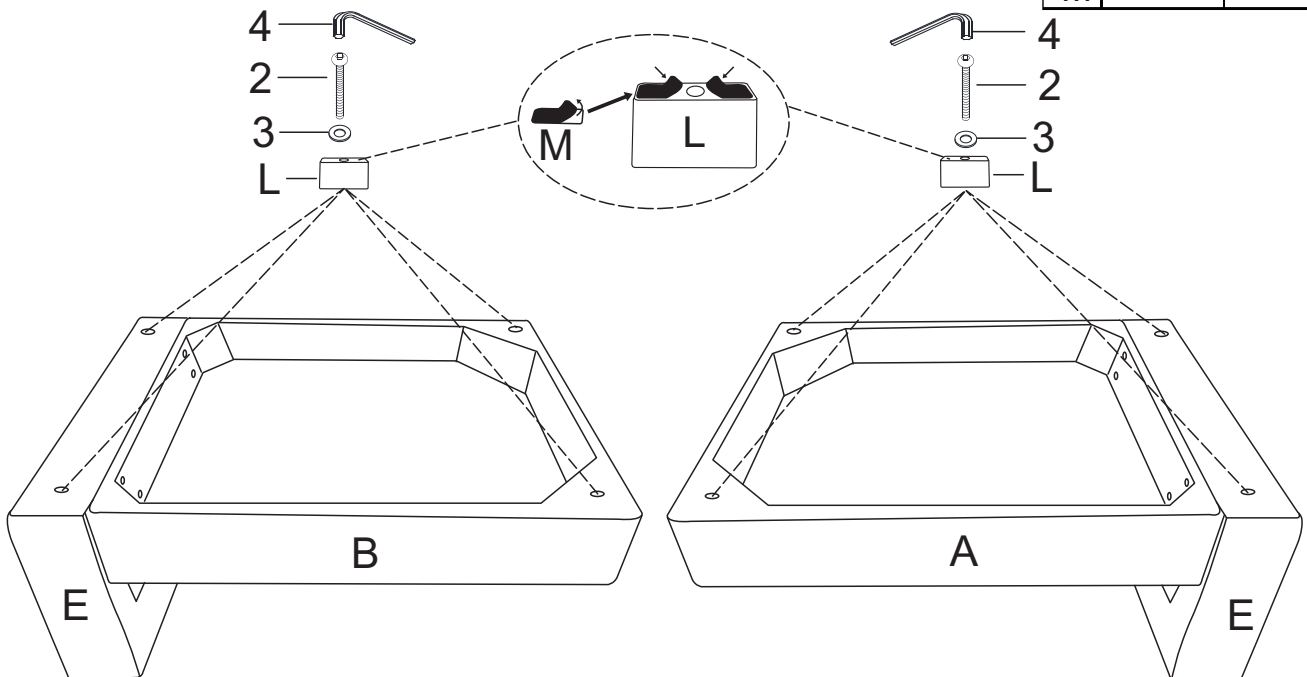







DIAGRAM4 (Assemble the Legs)

2		8PCS
3		8PCS
4		1PC
L		8PCS
M		16PCS

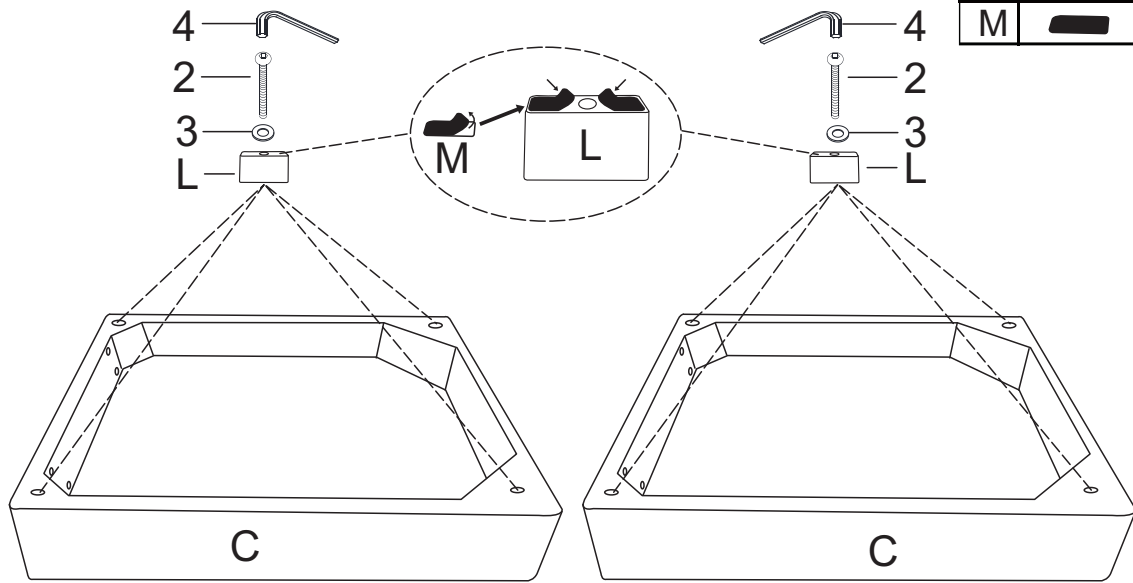







DIAGRAM5 (Assemble the Legs)

2		4PCS
3		4PCS
4		1PC
L		4PCS
M		8PCS

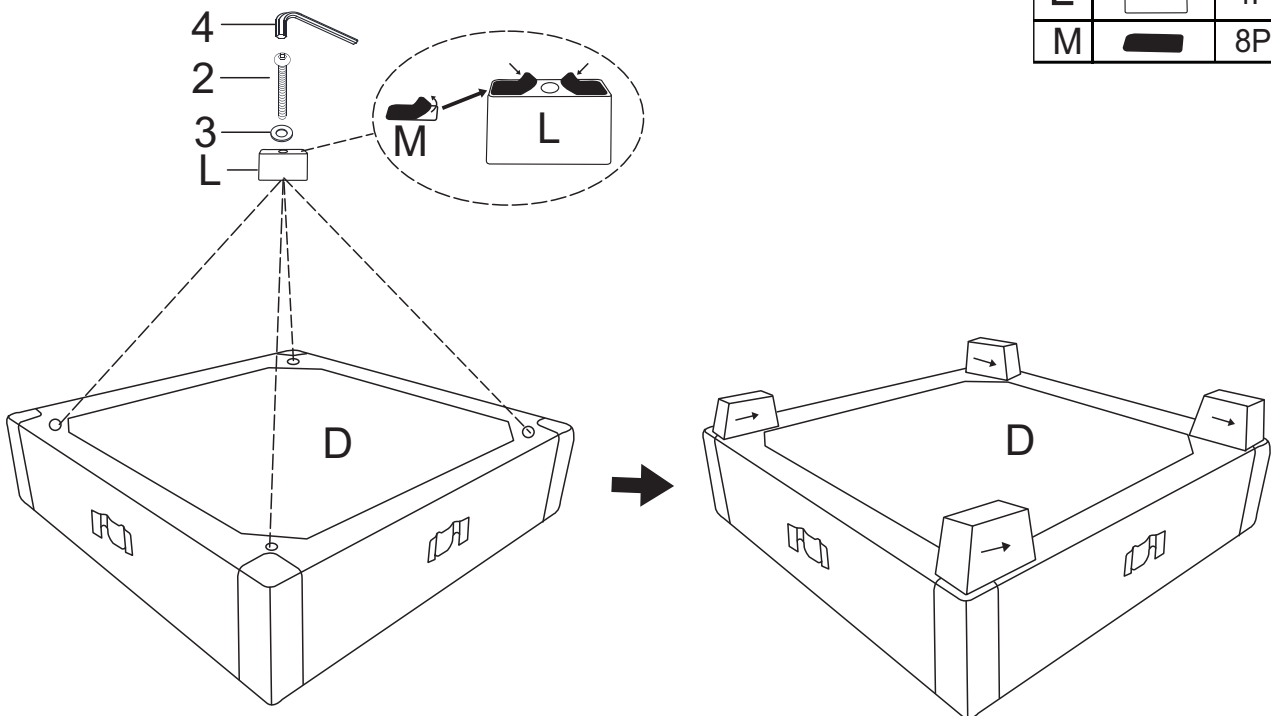





DIAGRAM 6 (Assemble the Back frames)

Connect the Back frames (Part F) with Screws M8x35mm(Hardware1) and Washers (Hardware 3) by Wrench(Hardware4) as shown. Then put Velcro pieces together.

Please install the top Screws first, then the bottom Screws.

Make sure all the Screws are in the holes before tightening them.

1		8PCS
3		8PCS
4		1PC

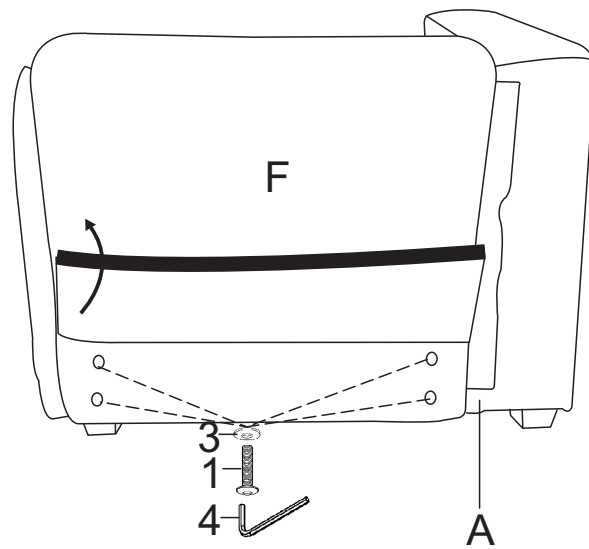
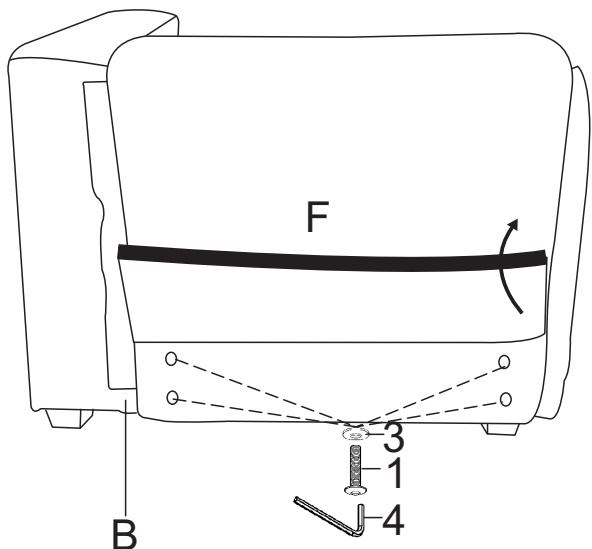
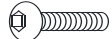



DIAGRAM 7 (Assemble the Back frames)

Connect the Back frames (Part F) with Screws M8x35mm(Hardware1) and Washers (Hardware 3) by Wrench(Hardware4) as shown. Then put Velcro pieces together.

Please install the top Screws first, then the bottom Screws.

Make sure all the Screws are in the holes before tightening them.

1		8PCS
3		8PCS
4		1PC

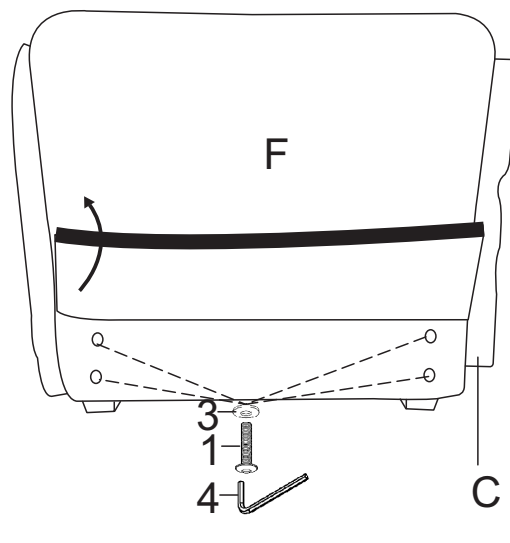
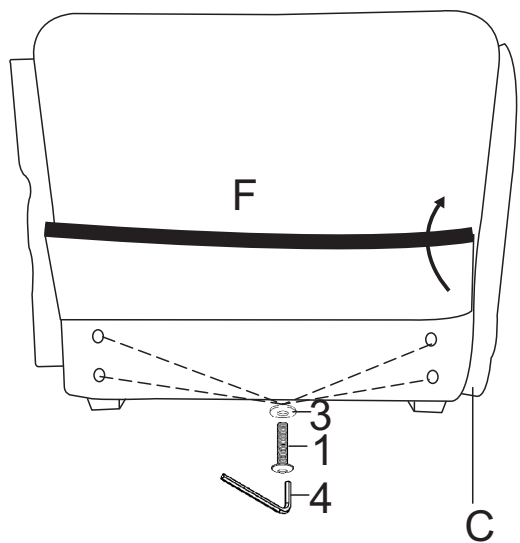





DIAGRAM 8 (Assemble the Corner back frames)

Connect the Corner back frames (Part G) with Screws M8x35mm(Hardware1) and Washers (Hardware 3) by Wrench(Hardware4) as shown. Then put Velcro pieces together.

Please install the top Screws first, then the bottom Screws.

Make sure all the Screws are in the holes before tightening them.

1		8PCS
3		8PCS
4		1PC

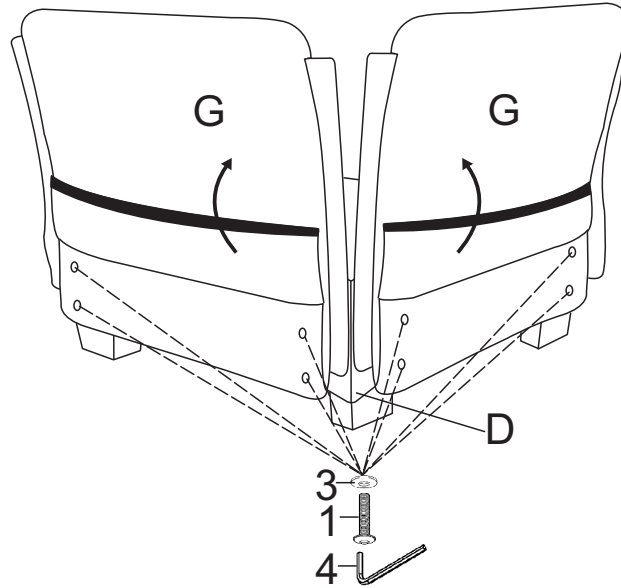

DIAGRAM9 (Connecting the Seat frames)

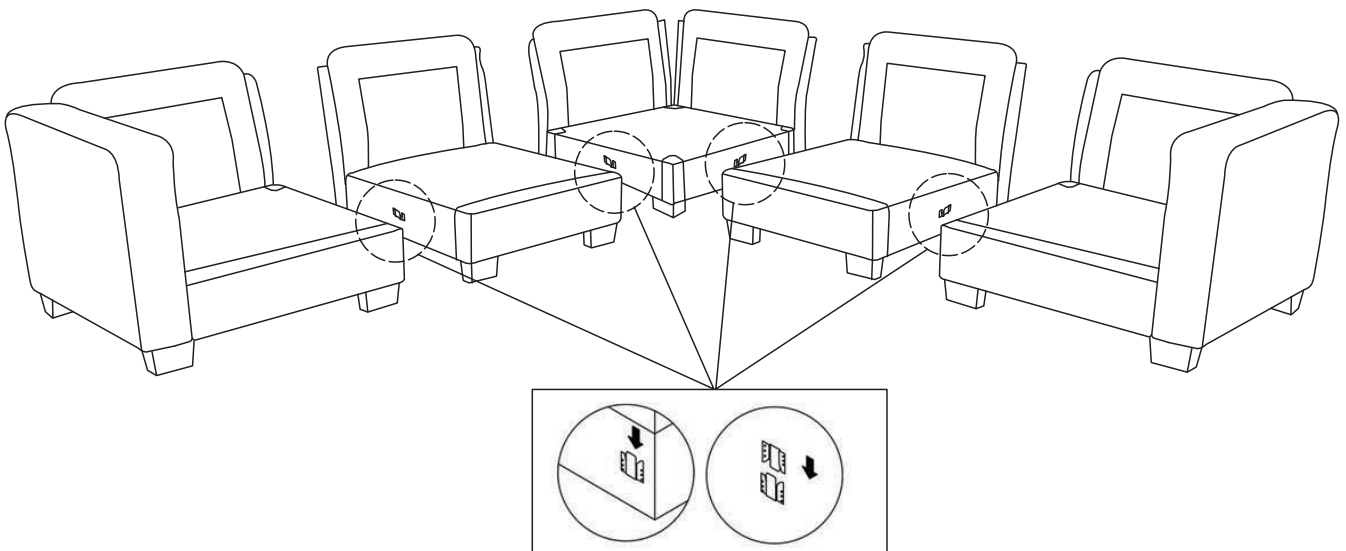

DIAGRAM10 (Removal of compressed bags)

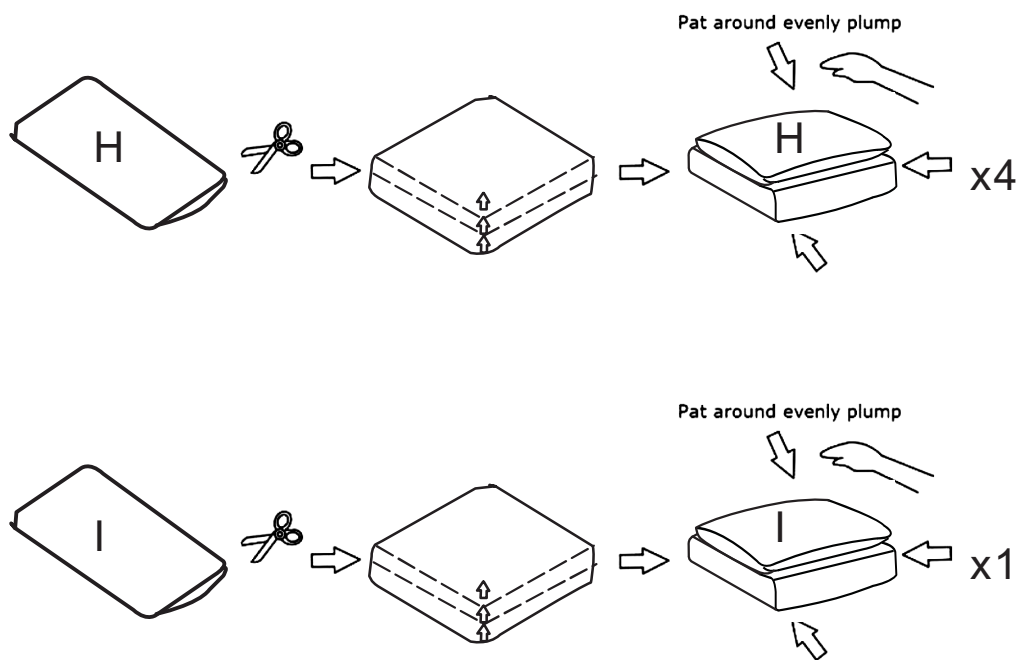
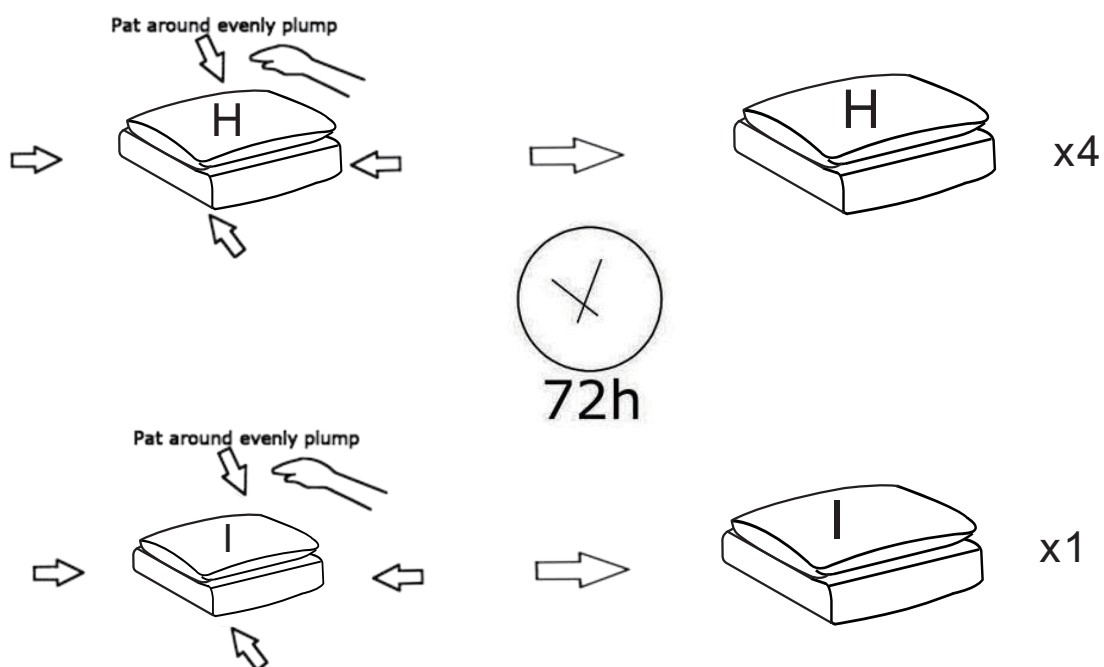

DIAGRAM11 (Waiting for 72h)



TIPS:

1. Please do not open the compressed packages until your sofa frame is completely assembled.
2. Compressed cushions need to be fully fulfilled within 72 hours for your perfect use.
3. Please keep children away from plastic bags or any small pieces of stuff.

DIAGRAM 12 (Place cushions on the sofa)

Put the Seat cushions(Part H&I)and the Back cushions(Part J&K) on the sofa.

Recheck all the bolts before you sit on the sofa.

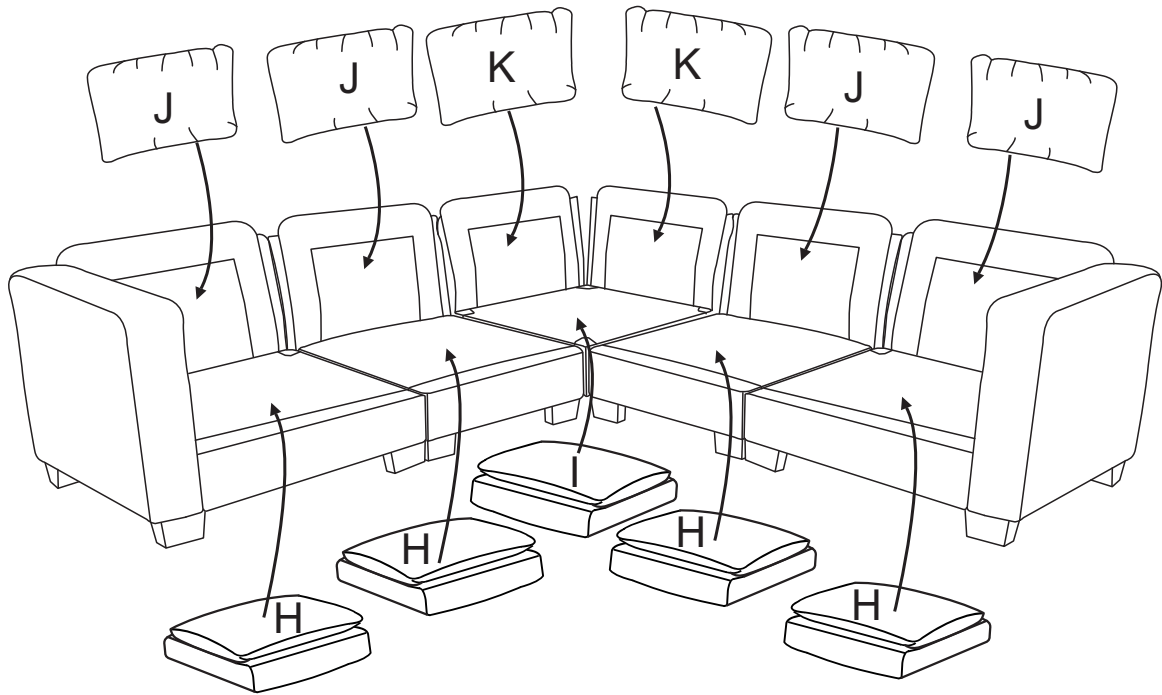

COMPLETE