

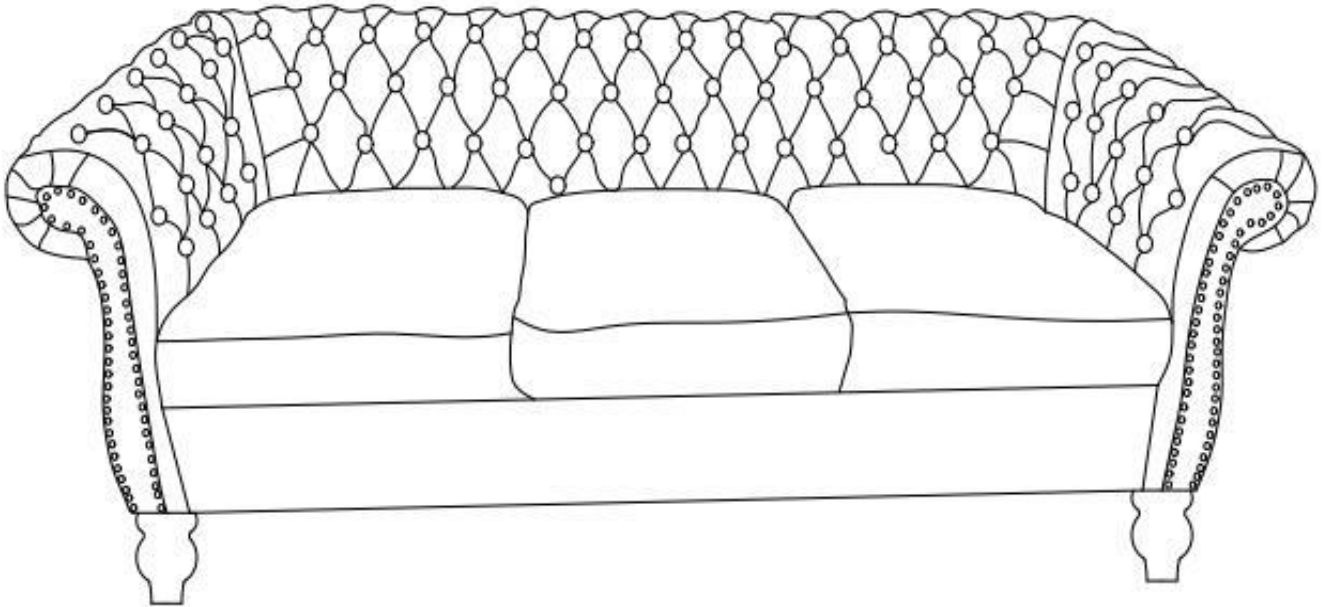



# Assembly Instructions

Caution: You must read this before you proceed



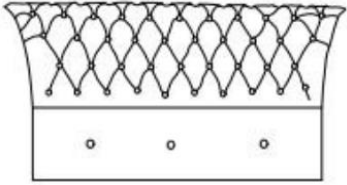
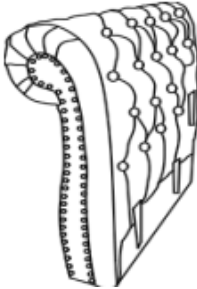
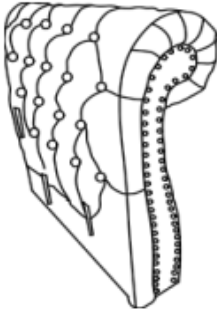
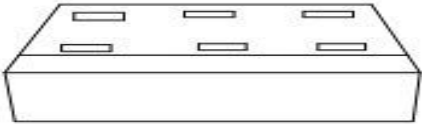

## Sofa



# Part List

Label	Picture	Description	QTY
A		Backrest	1
B		Left Armrest	1
C		Right Armrest	1
D		Seat	1
E		Seat Cushion	3
F		Sofa Leg	4
G		Middle Support Leg	1

# Hardware

Label	Picture	Description	QTY
①		Bolt (M8*70MM)	6
②		Washer	6
③		Gasket	8
④		Allen Wrench	1
⑤		Spring Washer	6

# Assembly Preparation

Before Beginning Assembly:

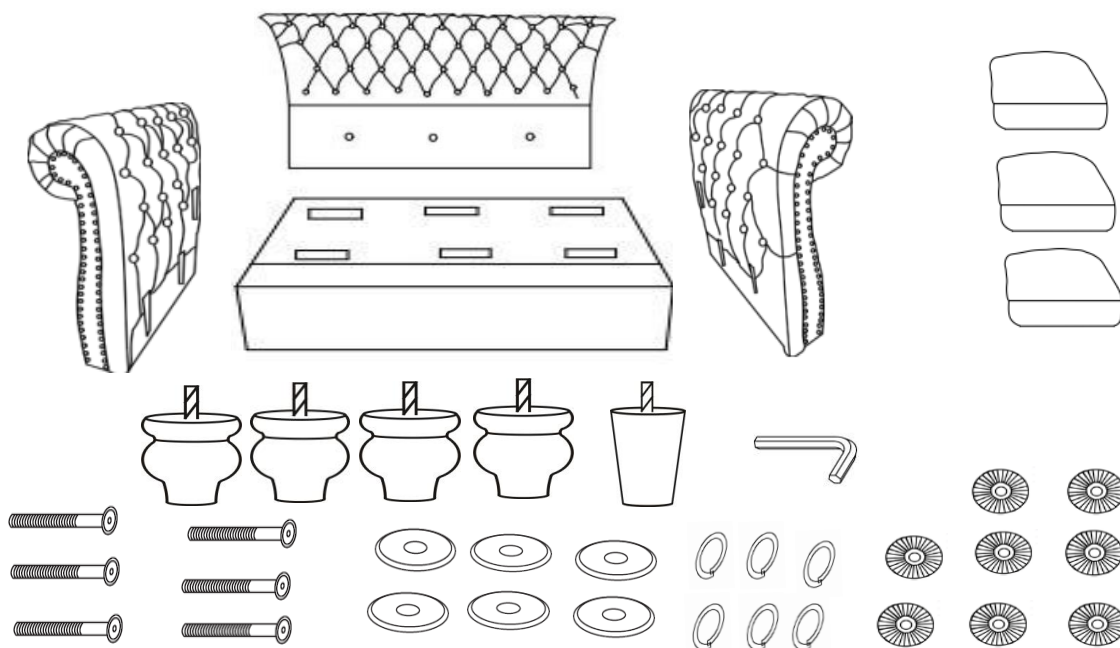

- Read instructions, cover to cover-



- Have 2 adults on hand for assembly-



- Do not assemble on flooring or carpet-



- Assemble on a clean non-marring surface (packing foam)-



- Save all packaging until finished-

## Assembly Steps

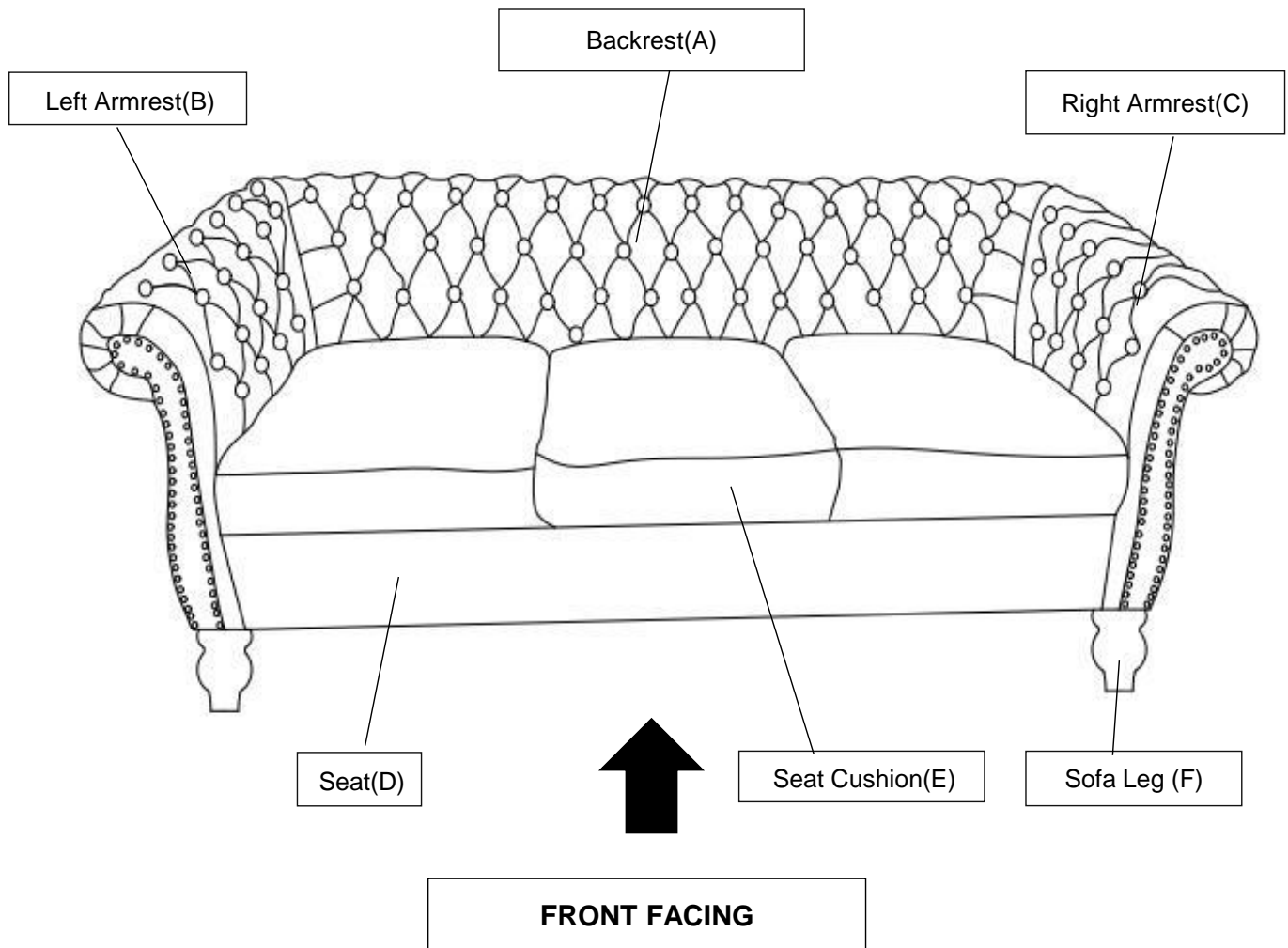

This Sofa has multiple parts and may require up to 60 minutes to assemble. To give you an overview of the Sofa parts, the above picture is to help you put the various parts into perspective. Please read through the instructions below to familiarise yourself with the parts and steps before assembly.

**Note: It is recommended that you have an adult partner to assist during the entire assembly process.**

## Step 1

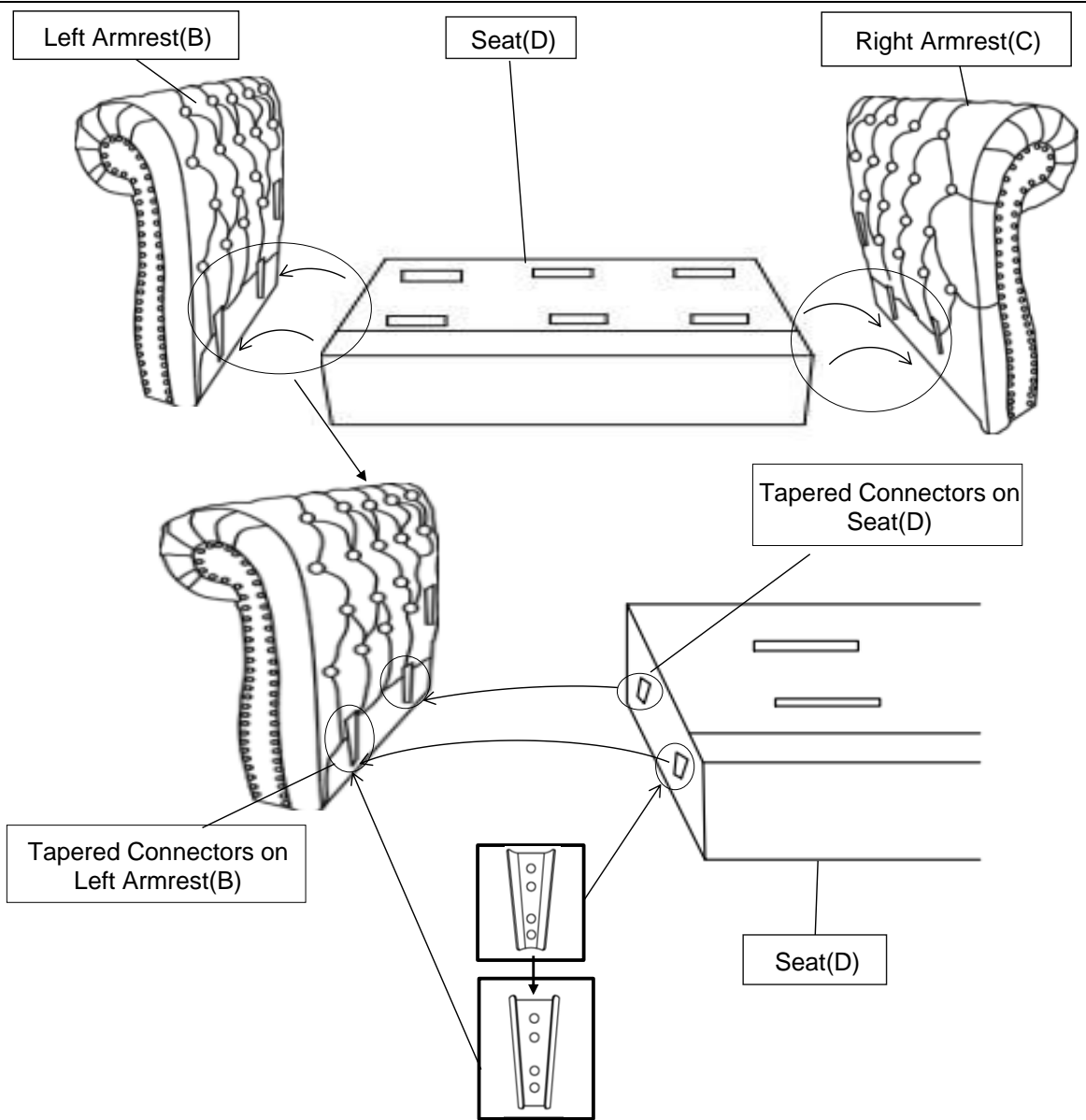

Open the carton and place all the parts on a clean, non-marring surface.

With the assistance of your partner, slide the Tapered Connectors on the Seat(D) into the Tapered Connectors on the Left Armrest(B).

Repeat the same process with the Right Armrest(C).

**Note: Make sure the Tapered Connectors on Left Armrest(B) and Right Armrest(C) lock into the Tapered Connectors on the Seat(D).**

**Assistance from an adult partner is needed for this assembly process.**

**During this assembly process - do exercise caution. You may need to use your hand to press down and or pave away the padded surface to facilitate the 'slip and slide' assembly.**

**Caution: Ensure that your fingers do not get caught or pinched in the assembly process.**

## Step 2

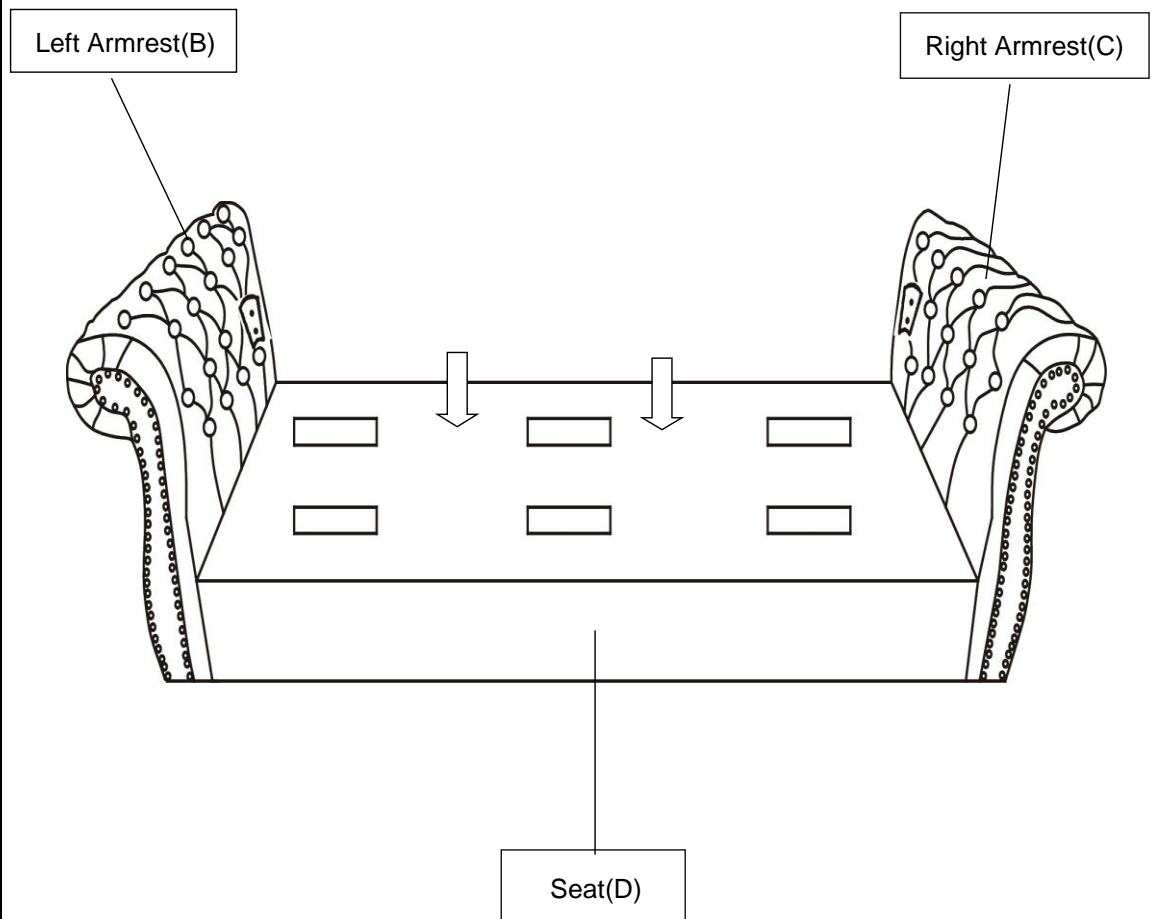

Push the Seat(D) downwards until it is fully slotted and locked into position in the Armrests.

**Fully locked position: Check and assess that the base of the Armrests(B&C) and Seat(D) are aligned and level.**

**Assistance from an adult partner is needed for this assembly process.**

## Step 3

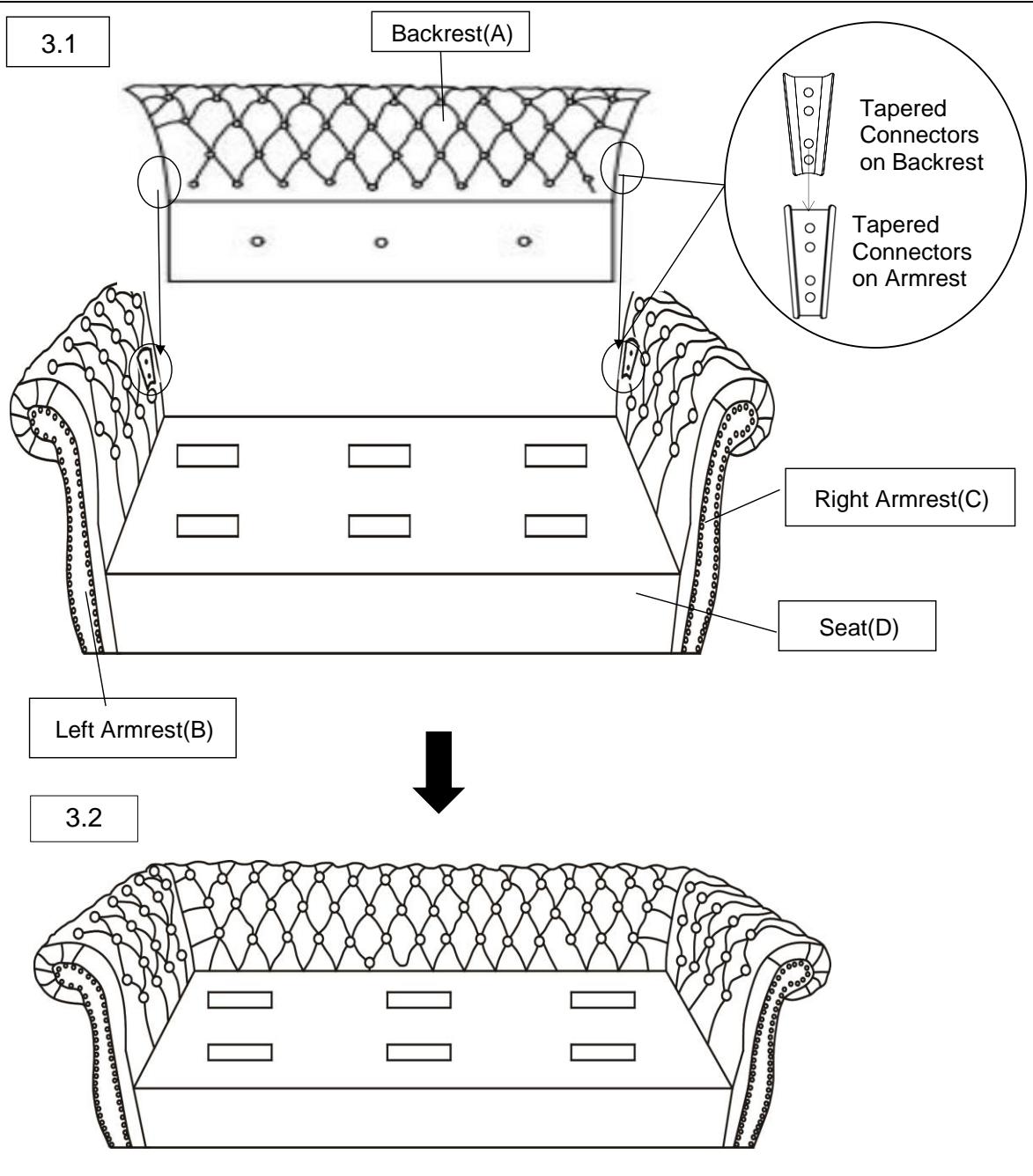

With the assistance from your partner.

**3.1)** Lift the Backrest(A) up, make sure the Backrest(A) is vertical and aligned to the Seat and Armrests. Align the Tapered Connectors on the Backrest(A) with those on the Left Armrest(B) and Right Armrest(C).

Your adult partner may need to push the Armrests inwards to the Backrest(A) to allow for better alignment.

Slip and slide the Backrest, in a gradual and balanced manner into the Tapered Connectors.

**3.2)** Push the Backrest(A) downwards until it is fully slotted and locked into position.

**Note: Make sure the Tapered Connectors on the Backrest(A) lock into the Tapered Connectors on Left Armrest(B) and Right Armrest(C).**

**Fully locked position: Check and assess that the base of the Armrests(B&C) and Seat(D) are aligned and level.**

**Assistance from an adult partner is needed for this assembly process.**

## Step 4

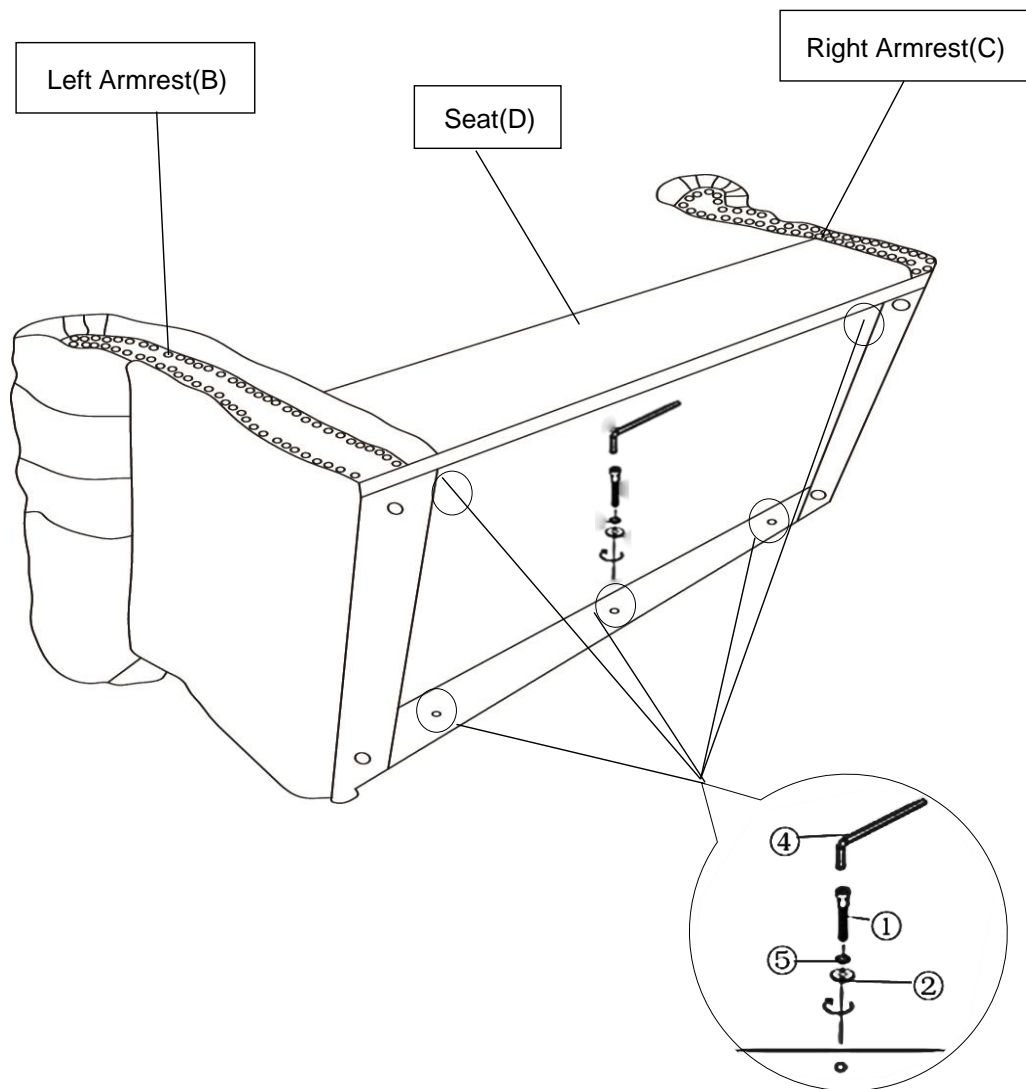

Tilt and lay the Sofa on its Backrest(A) onto a flat surface.

Attach Seat(D) to Backrest(A) using Bolts(①), Spring Washers(⑤), and Washers(②) with Allen Wrench(④) as pictured above.

Then, attach Seat(D) to Left Armrest(B) and Right Armrest(C) using Bolts(①), Spring Washers(⑤), and Washers(②) with Allen Wrench(④).

Tighten the Bolts fully in a sequential manner.

**DO NOT fully tighten a Bolt in one go and then move on to the next.**

**Rather, In a sequential manner, gradually tighten each Bolt until all Bolts are evenly secured. This methodology will ensure maximum evenness once all Bolts are fully tightened.**

**Note: If you can not insert the Bolts into position, please back to Step 3 to "push Backrest downwards".**



## Step 5

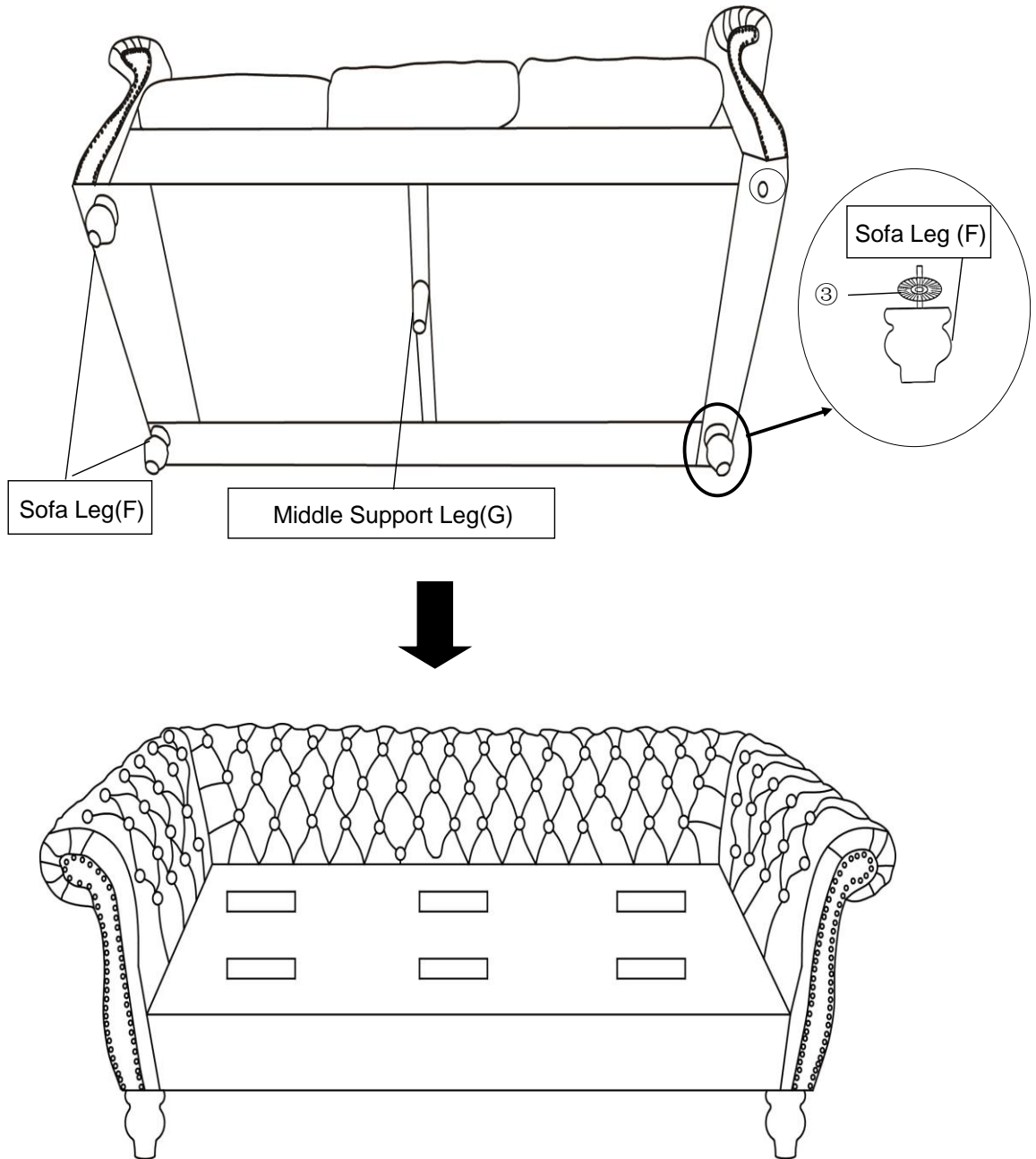

Install the Sofa Leg(F) at the bottom of the sofa by placing one Gasket(③) on the threaded stem. Then insert threaded stem into the threaded mounting position at the corner of the Sofa. Tighten by turning the Leg clockwise.

Repeat the same step to install the remaining four Legs.

**Note: The use of Gaskets are OPTIONAL and are especially useful to help alleviate slight wobbles. Some Legs may need more than one whilst some legs may not need any.**

Step 6

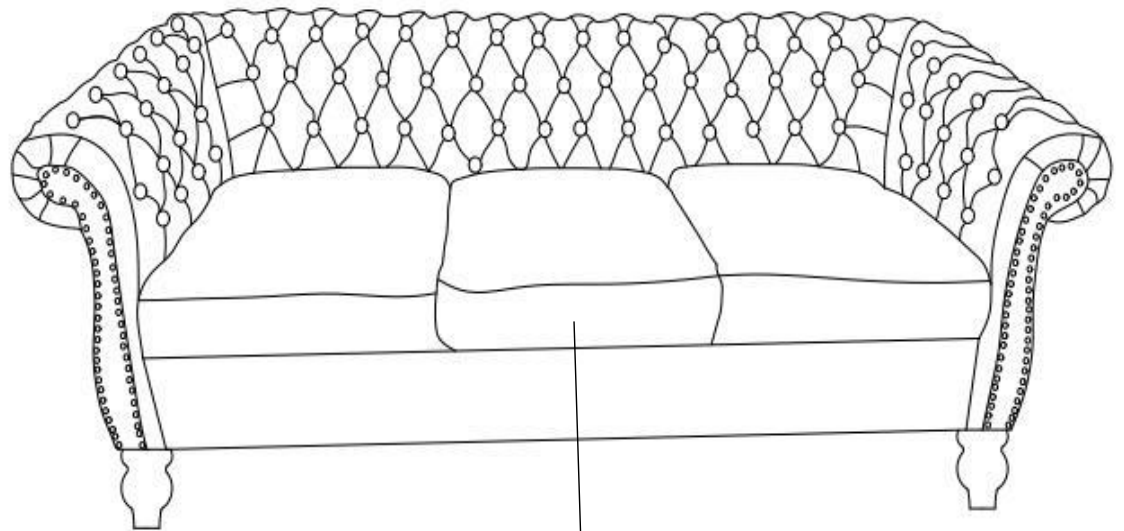

Seat Cushion(E)

Place the Seat Cushions(E) onto the Sofa.

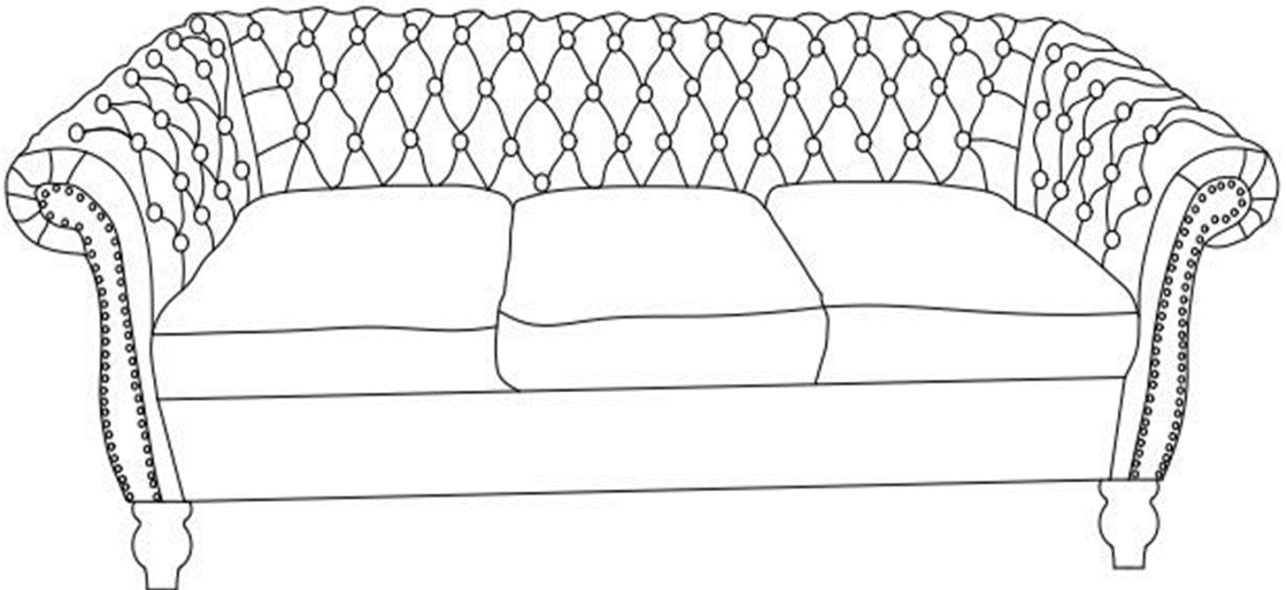

Your Sofa is ready for use.

**This Sofa can only be used on a flat, level surface.**

## Care & Maintenance



- Furniture may scratch floors. We recommend using furniture pads to protect your floors.



- Do not put hot items directly on furniture surface.



- Do not clean furniture with harsh cleansers or polish.



- Do not place furniture under direct sunlight.



- Do not place furniture near heating or cooling vents.



- Do not write on furniture without a padded barrier to protect the surface.



- Do not place furniture outside . For indoor use only.



- Not for commercial use. For residential use only.



- Stains may be removed with mild soap solution and damp cloth.



- Children should not climb or jump on the furniture.



- Dust and pick-up spills using a clean, non-colored, lint-free cloth.