

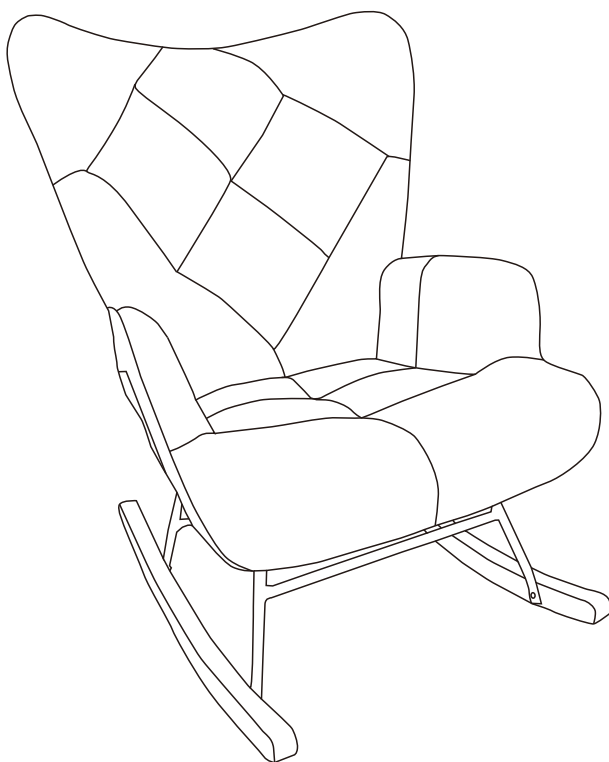

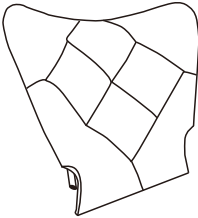

Stylor Rocking Chair

Assembly Insturction

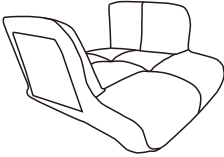
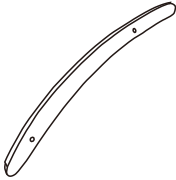
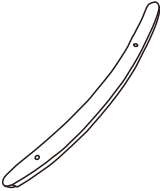
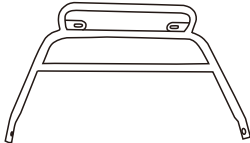
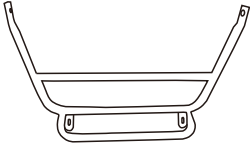

<p>A</p>  <p>x 1</p>	<p>B</p>  <p>x 1</p>	<p>C</p>  <p>x 1</p>
<p>D</p>  <p>x 1</p>	<p>E</p>  <p>x 1</p>	<p>F</p>  <p>x 1</p>
<p>G</p>  <p>x 2</p>	<p>H M6*16</p>  <p>x 4</p>	<p>I M6*25</p>  <p>x 4</p>
<p>J M6*60</p>  <p>x 2</p>	<p>K</p>  <p>x 1</p>	

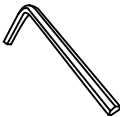
Attention :

1.screws should be only 50% tight.

2.after all the screws adjust the holes then tight screws 100% totally.

1

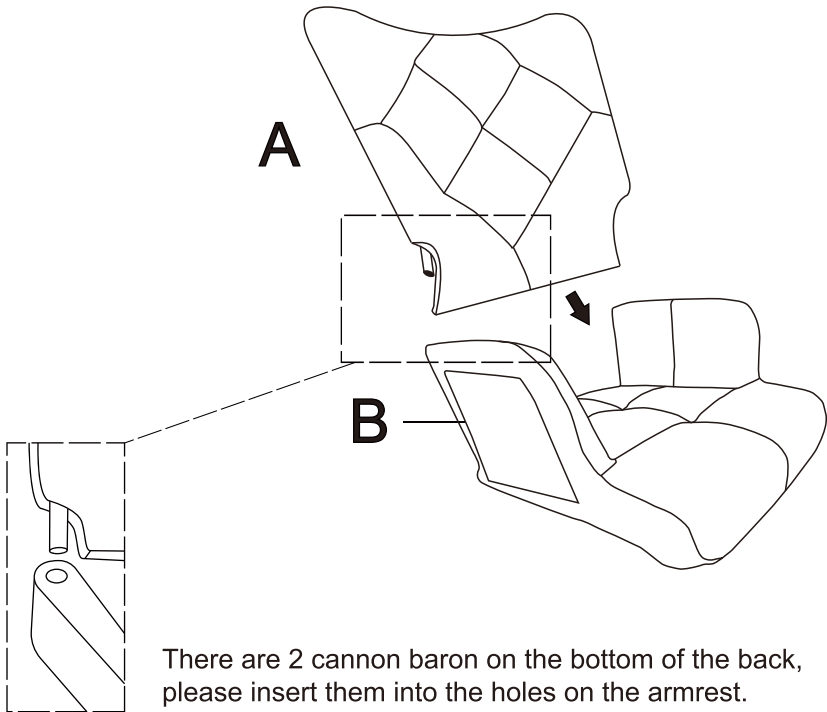

There are 2 cannon baron on the bottom of the back, please insert them into the holes on the armrest.

Attention :

1.screws should be only 50% tight.

2.after all the screws adjust the holes then tight screws 100% totally.

2

Hold the backrest
and press down

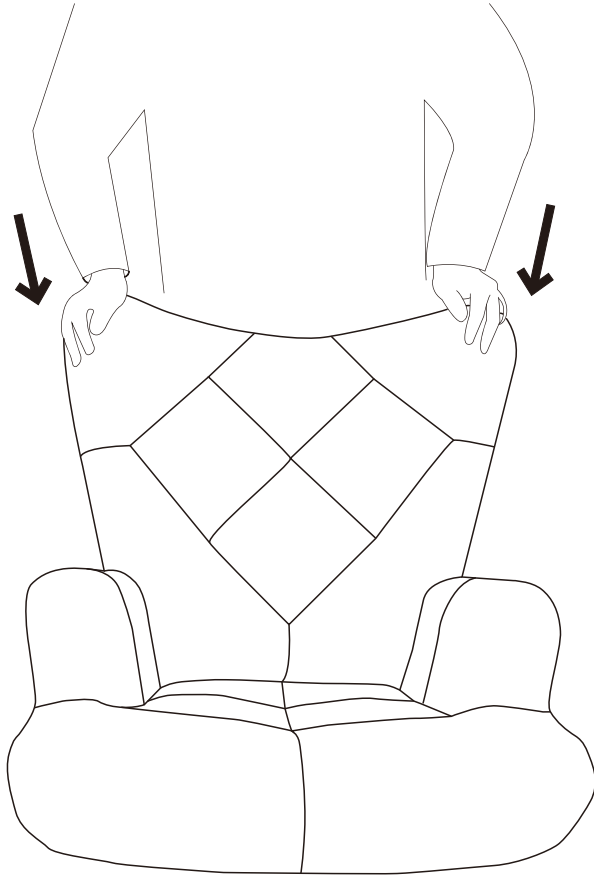

Attention :



- 1.screws should be only 50% tight.
- 2.after all the screws adjust the holes then tight screws 100% totally.

3

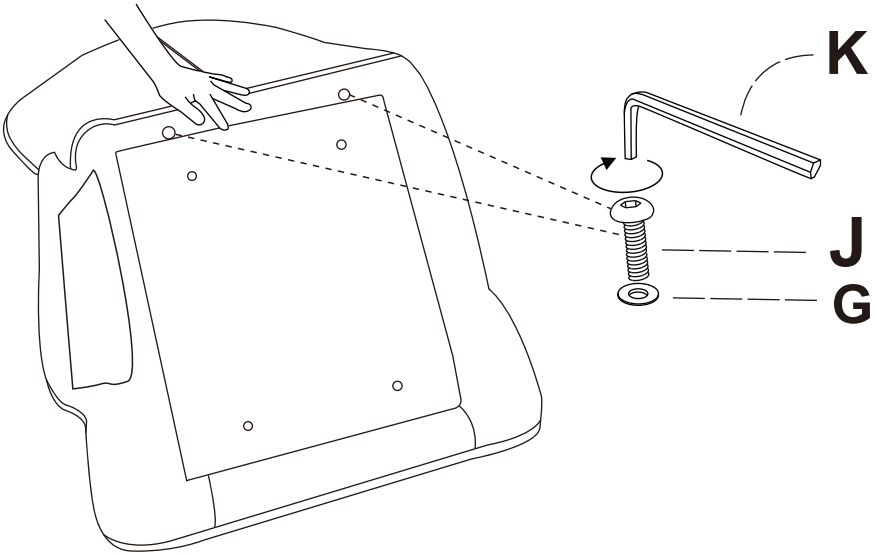
Make sure the back and the bottom tight fit, then drew the screws in, then tighten.



X2

G		2PCS
J		2PCS

Attention :

1.screws should be only 50% tight.

2.after all the screws adjust the holes then tight screws 100% totally.

4

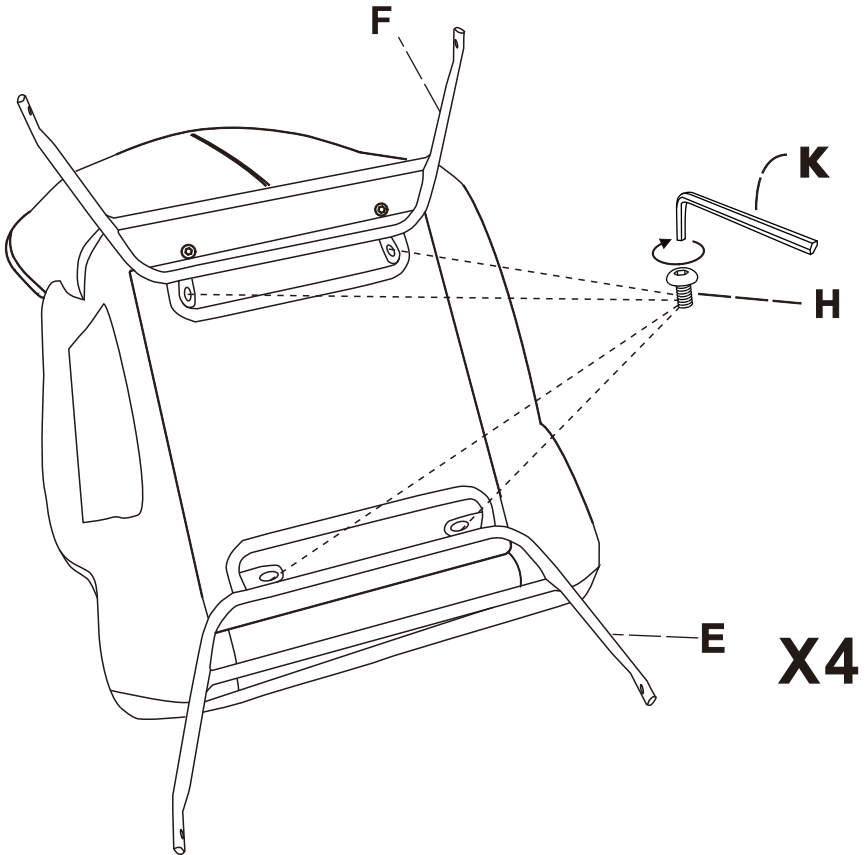

H



4 PCS

Attention :

1.screws should be only 50% tight.

2.after all the screws adjust the holes then tight screws 100% totally.

5

Make sure the longer side of C and D is facing the back of the chair.

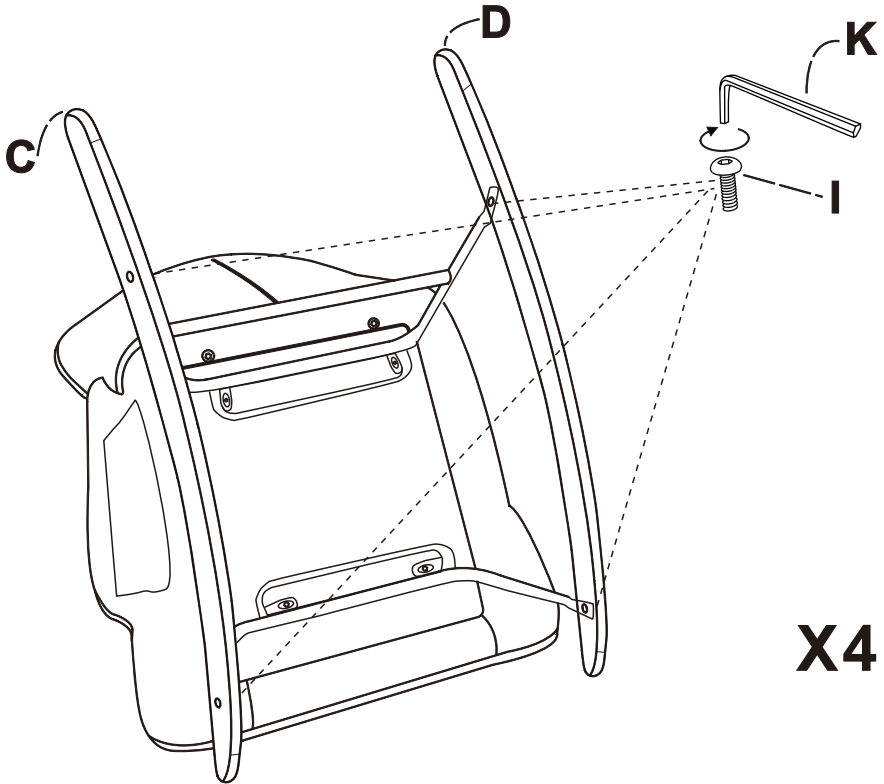

4PCS