

# ASSEMBLY INSTRUCTIONS

BES-S-019

Ax2

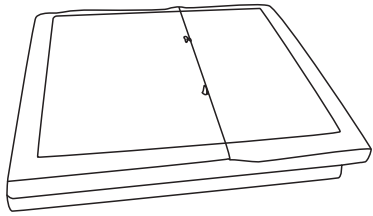

Bx2

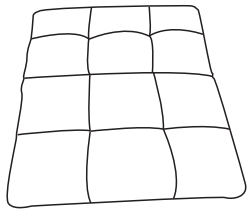

Cx4

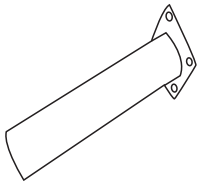

Dx2

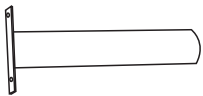

Ex6



Fx20



Gx1



1

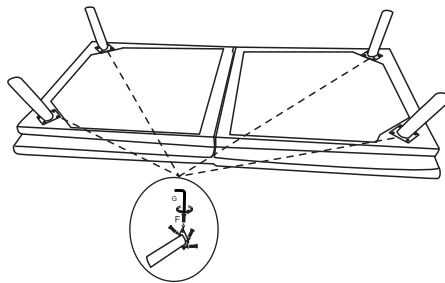

2

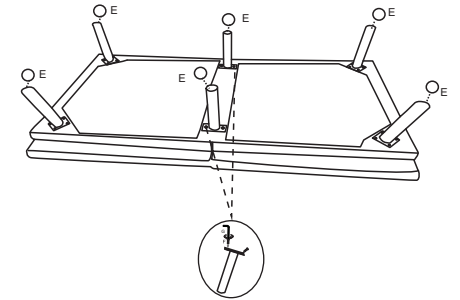

3

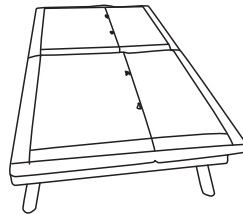

4

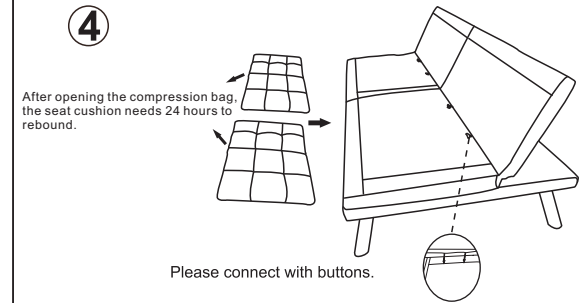

5

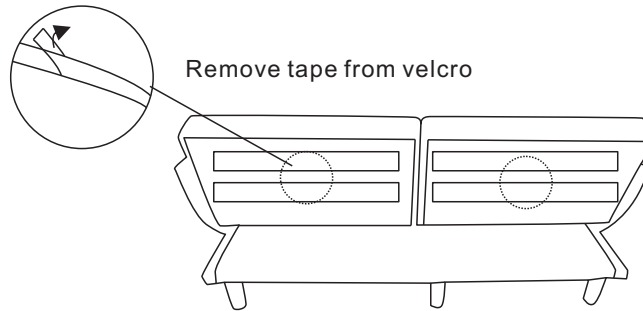

6

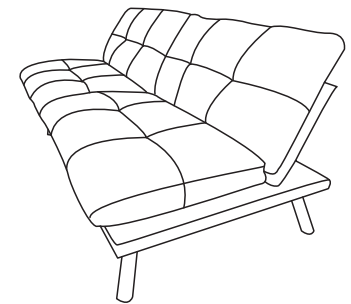

7

