

Assembly Instructions

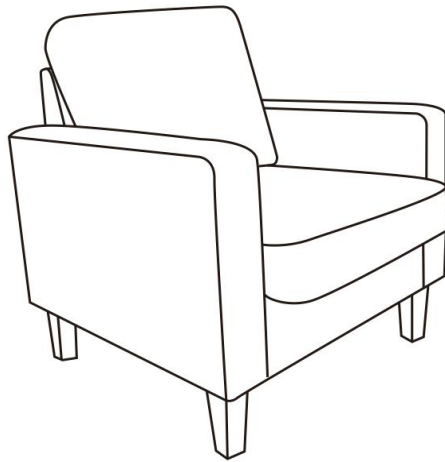



Caution: You must read this before you proceed

Chair

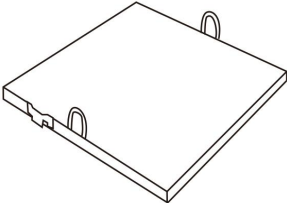
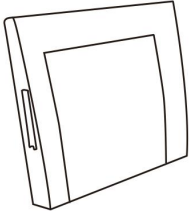
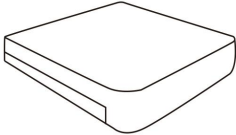

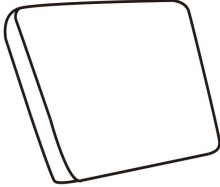
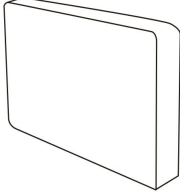
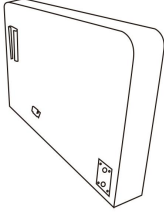
Parts List

Label	Picture	Description	QTY
A		Seat Base	1
B		Backrest	1
C		Seat Cushion	1

D		Back Cushion	1
E		Left Arm	1
F		Right Arm	1
G		Front Seat Board	1
H		Wooden Leg with 1 Plastic Gasket	4
Hardwares List			
①		Plastic Gasket	3
②		Allen Key	1

Assembly Preparation

Before
Beginning
Assembly:

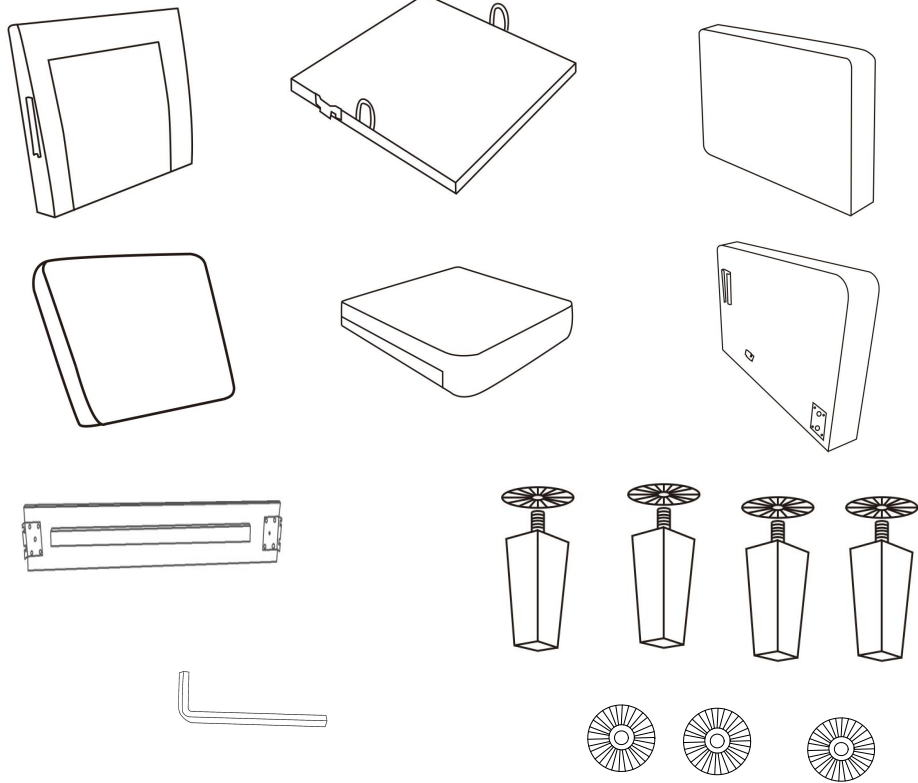

- Read instructions, cover to cover-



- Have 2 adults on hand for assembly-



- Do not assemble on flooring or carpet-



- Assemble on a clean non-marring surface (packing foam)-



- Save all packaging until finished-

Assembly Steps

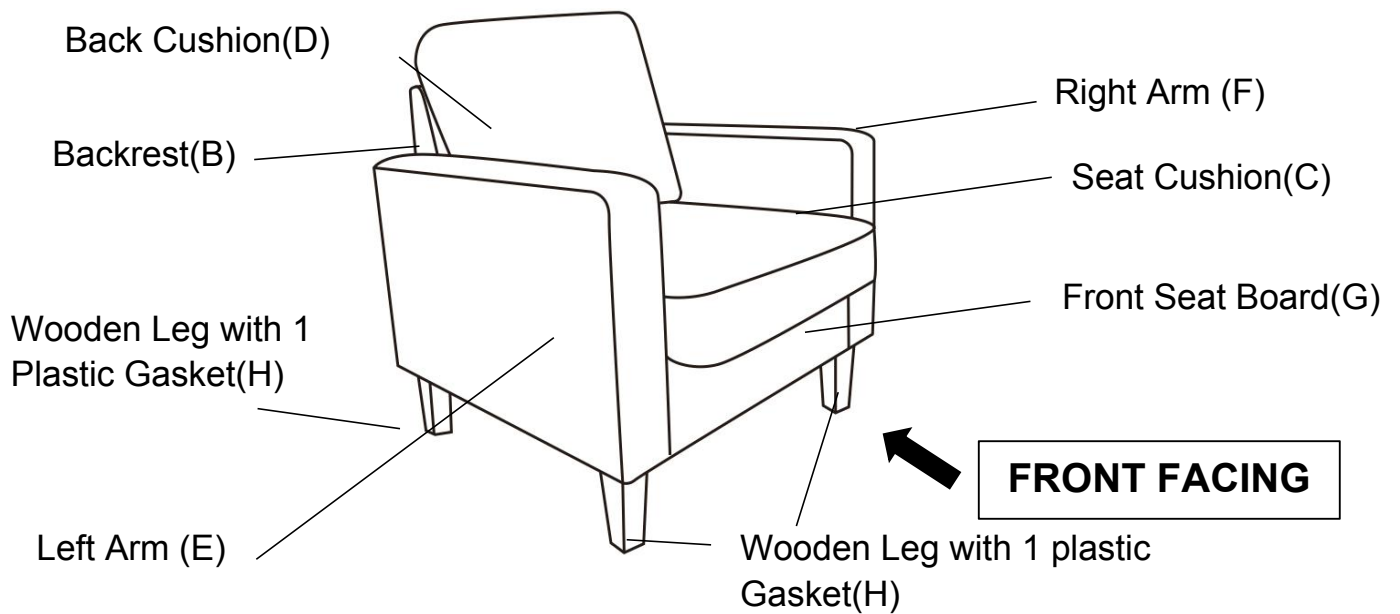

This Chair has multiple parts and may require about 30 minutes to assemble. To give you an overview of the Loveseat parts, the above picture is to help you put the various parts into perspective. Please read through the instructions below to familiarise yourself with the parts and steps before assembly.

Step 1

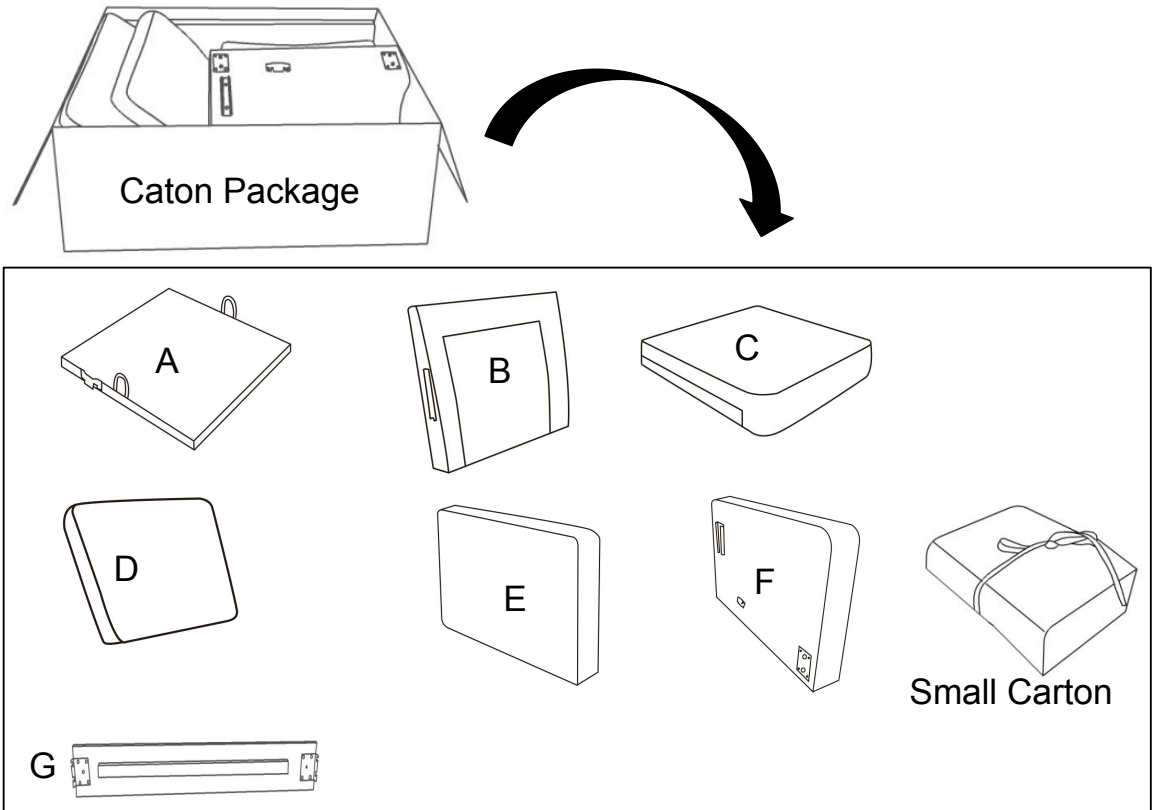

Take the Seat Base(A), Backrest(B), Seat Cushion(C), Back Cushion(D), Left Arm (E), Right Arm (F), Front Seat Board(G), and Small carton out from the carton and place them on a clean, non-marring surface.

Step 2

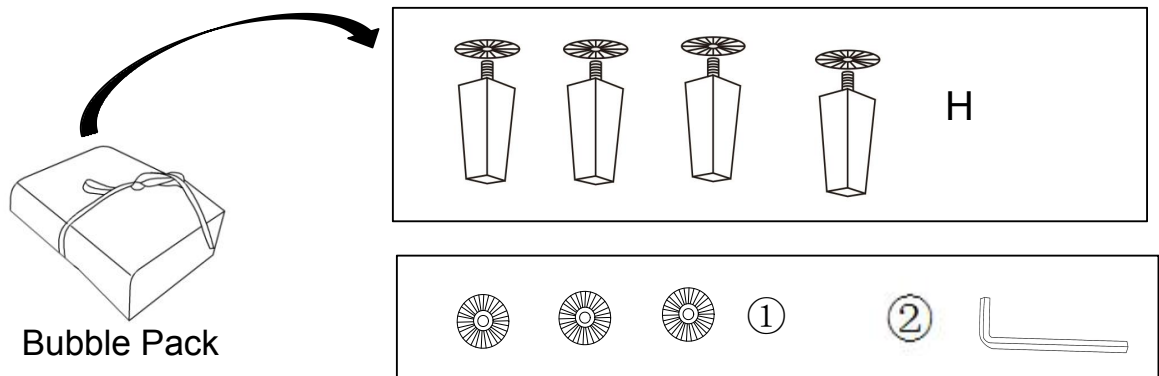

Open the Small Carton to take out the Wooden Leg with 1 Plastic Gasket(H) with 3 Plastic Gasket(①) and Allen Key(②).

Step 3

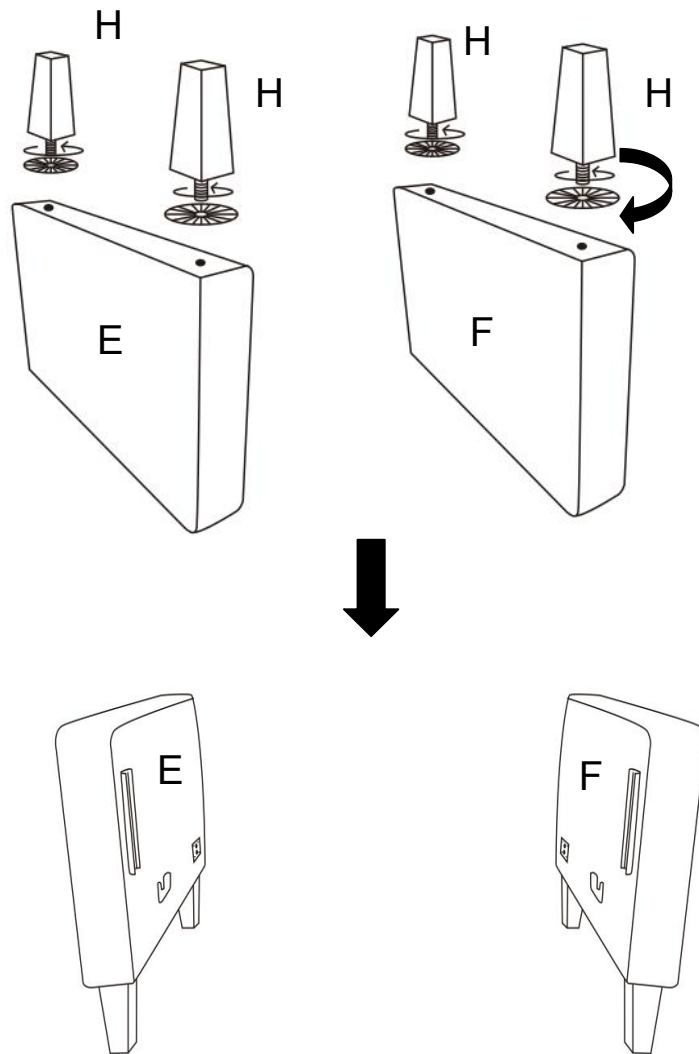

Carefully install the Legs with 1 Plastic Gaskets(①) at the bottom of the Left Arm(E) and Right Arm(F).

Insert threaded stem into the mounting position at the corner of the Left Arm(E) and Right Arm(F). Tighten by turning the Legs clockwise.

Take care of the shape of the Legs and ensure they in the correct postions.

Note:The use of Plastic Gasket are OPTIONAL and are especially useful to help alleviate slight wobbleness. Some Legs may need more than one gasket while some legs may not need any.

Step 4

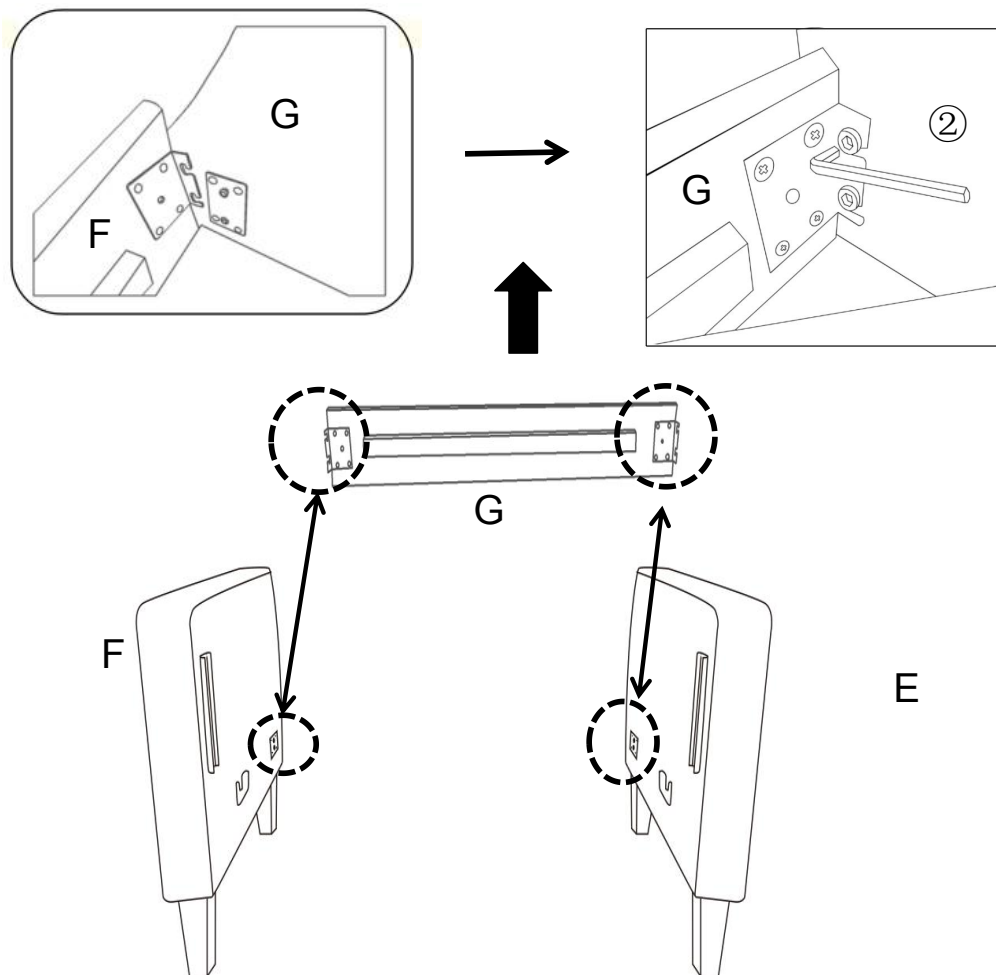

With assistance from your adult partner, position the Left Arm (E) and Right Arm (F) as picture, hold up the Front Seat Board (G) and stand behind the both Arms, assemble the Front Seat Board (G) by putting the metal hook on the two raised screws on the hind side of both arms and by tightening with Allen Key (2), do it one by one and make sure into position.

Step 5

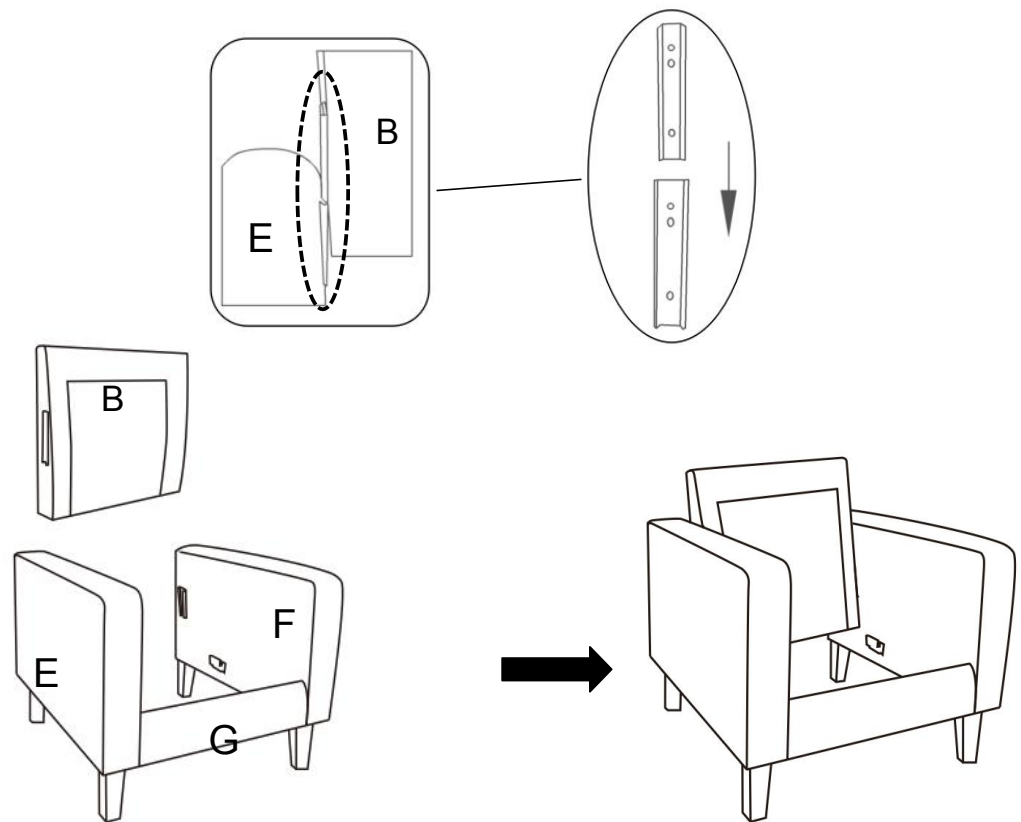

With assistance from your adult partner, position the Left Arm (E) and Right Arm (F) with Front Seat Board (G) as picture, hold up the Backrest (B) and stand behind the both Arms, Align the mounting brackets on both sides of the Backrest (B) with those on the hind of Left Arm (E) and Right Arm (F).

Then slide Backrest (B) downward to make sure it locks into place as pictured

Step 6

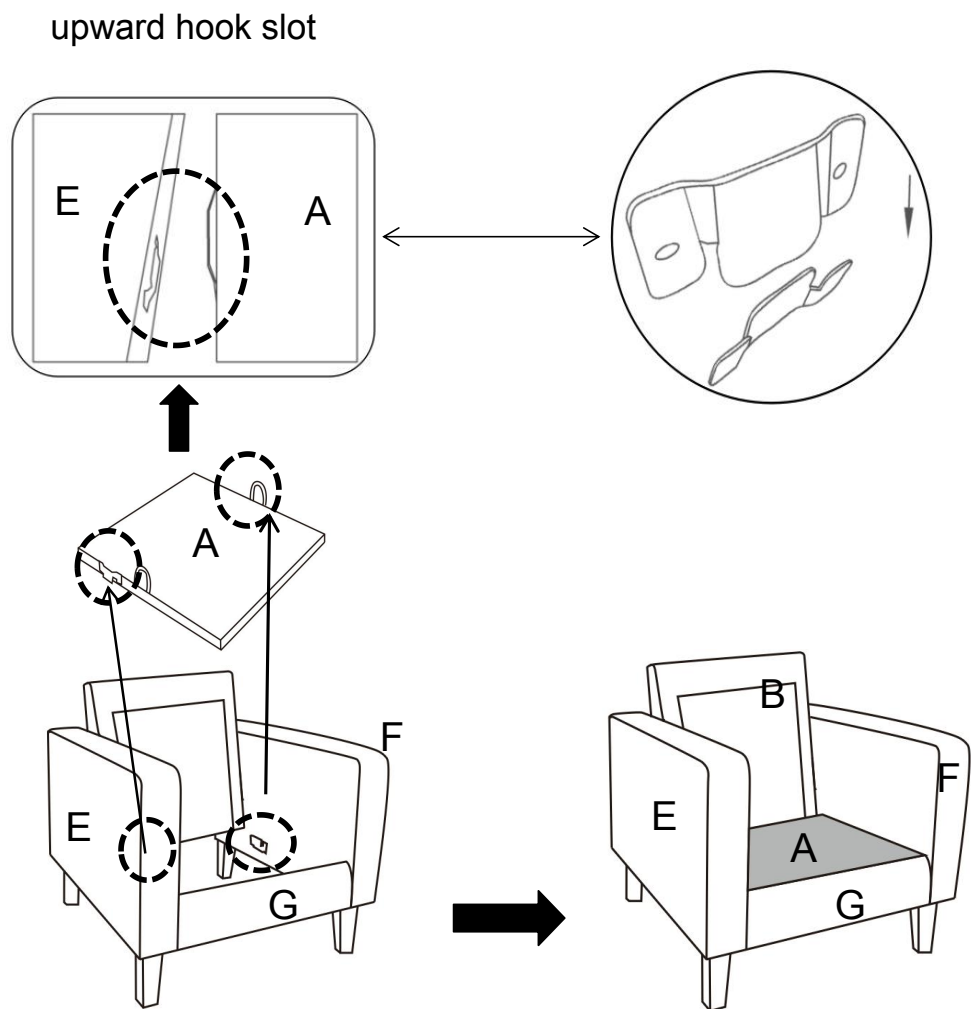

With assistance from your adult partner, hold up the Seat Base(A) on the top of the assembled parts, put the front side of Seat Base(A) over on the rail of Front Seat Board(G) as picture.

Then slide the two downward hooks on each side of the Seat Base(A) into the upward hooks slot on the Left Arm (E) and Right Arm (F), do it one back one and make sure into the position.

Step 7

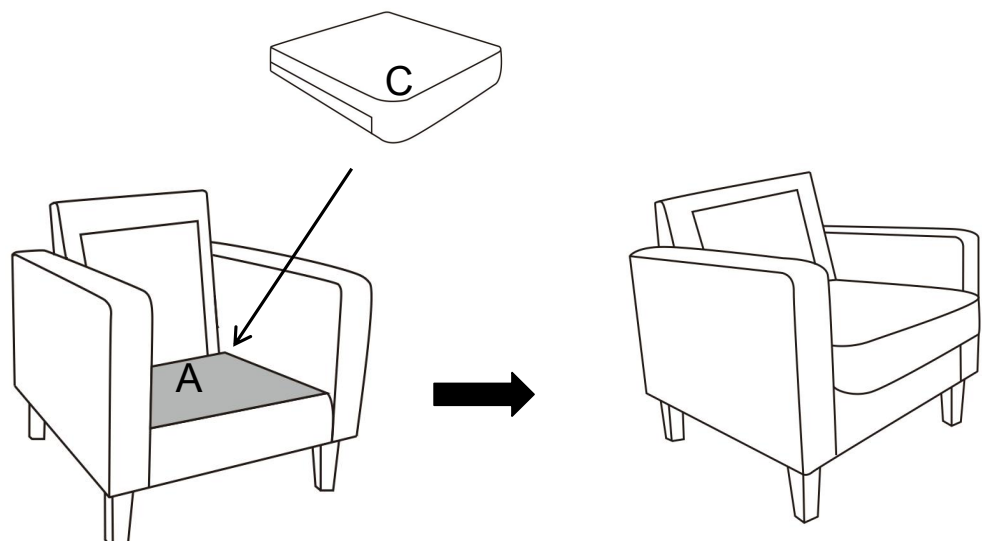





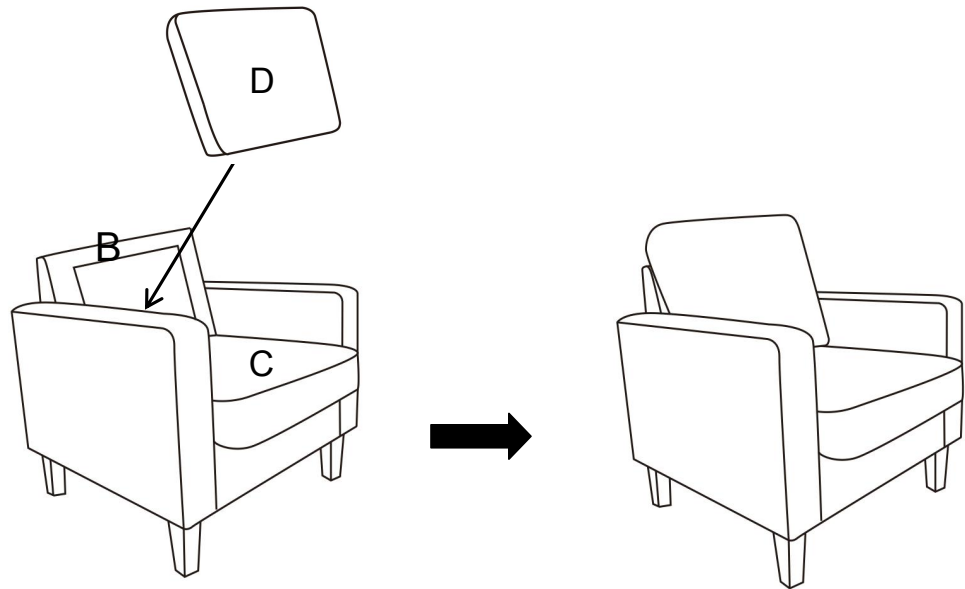





Put the Seat Cushion(C) on the Seat Base(A) and to the right position.

Step 8



Place the Back Cushion(D) against Backrest(B) and to the right position.
Make sure all parts are connected and securely locked into position
Your Chair is ready for use.
This Chair can only be used on a flat, level surface.

Care & Maintenance

-  Do not put hot items directly on furniture surface
 -  Do not clean furniture with harsh cleansers or polish.
 -  Do not place furniture under direct sunlight.
 -  Do not place furniture near heating or cooling vents.
 -  Do not write on furniture without a padded barrier to protect the surface.
 -  Do not place furniture outside . For indoor use only .
 -  Not for commercial use. For residential use only .
 -  Stains may be removed with mild soap solution and damp cloth.
 -  Children should not climb or jump on the furniture.
-
-  Dust and pick-up spills using a clean, non-colored, lint-free cloth .

Questions & Answers about Proposition 65

• What is Proposition 65?

Proposition 65 requires businesses to provide warnings to Californians about significant exposures to chemicals that cause cancer, birth defects or other reproductive harm. These chemicals can be in the products that Californians purchase, in their homes or workplaces, or that are released into the environment. By requiring that this information be provided, Proposition 65 enables Californians to make informed decisions about their exposures to these chemicals.

Proposition 65 also prohibits California businesses from knowingly discharging significant amounts of listed chemicals into sources of drinking water.

Proposition 65 requires California to publish a list of chemicals known to cause cancer, birth defects or other reproductive harm. This list, which must be updated at least once a year, has grown to include approximately 900 chemicals since it was first published in 1987.

• What types of chemicals are on the Proposition 65 list?

The list contains a wide range of naturally occurring and synthetic chemicals that include additives or ingredients in pesticides, common household products, food, drugs, dyes, or solvents. Listed chemicals may also be used in manufacturing and construction, or they may be byproducts of chemical processes, such as motor vehicle exhaust.

• What does a warning mean?

If a warning is placed on a product label or posted or distributed at a workplace, a business, or in rental housing, the business issuing the warning is aware or believes that it is exposing individuals to one or more listed chemicals.

By law, a warning must be given for listed chemicals unless the exposure is low enough to pose no significant risk of cancer or is significantly below levels observed to cause birth defects or other reproductive harm.

• Where can I get more information on Proposition 65?

If you have specific questions on the administration or implementation of Proposition 65, you can contact OEHHA's Proposition 65 program at P65.Questions@oehha.ca.gov, or by phone at (916) 445-6900.