

ASSEMBLY INSTRUCTION

WF326272 WF326273 WF326274 WF326275 WF326276

Friendly Reminder:

1. This sofa is packed in 5 boxes. Please assemble it after all boxes are received
2. As the cushions are all vacuum compressed, there will be some wrinkles. Please give your cushions up to 72 hours to reach its original size and the wrinkles will basically disappear.
3. Please do not open the compressed packages until your sofa frame is completely assembled.

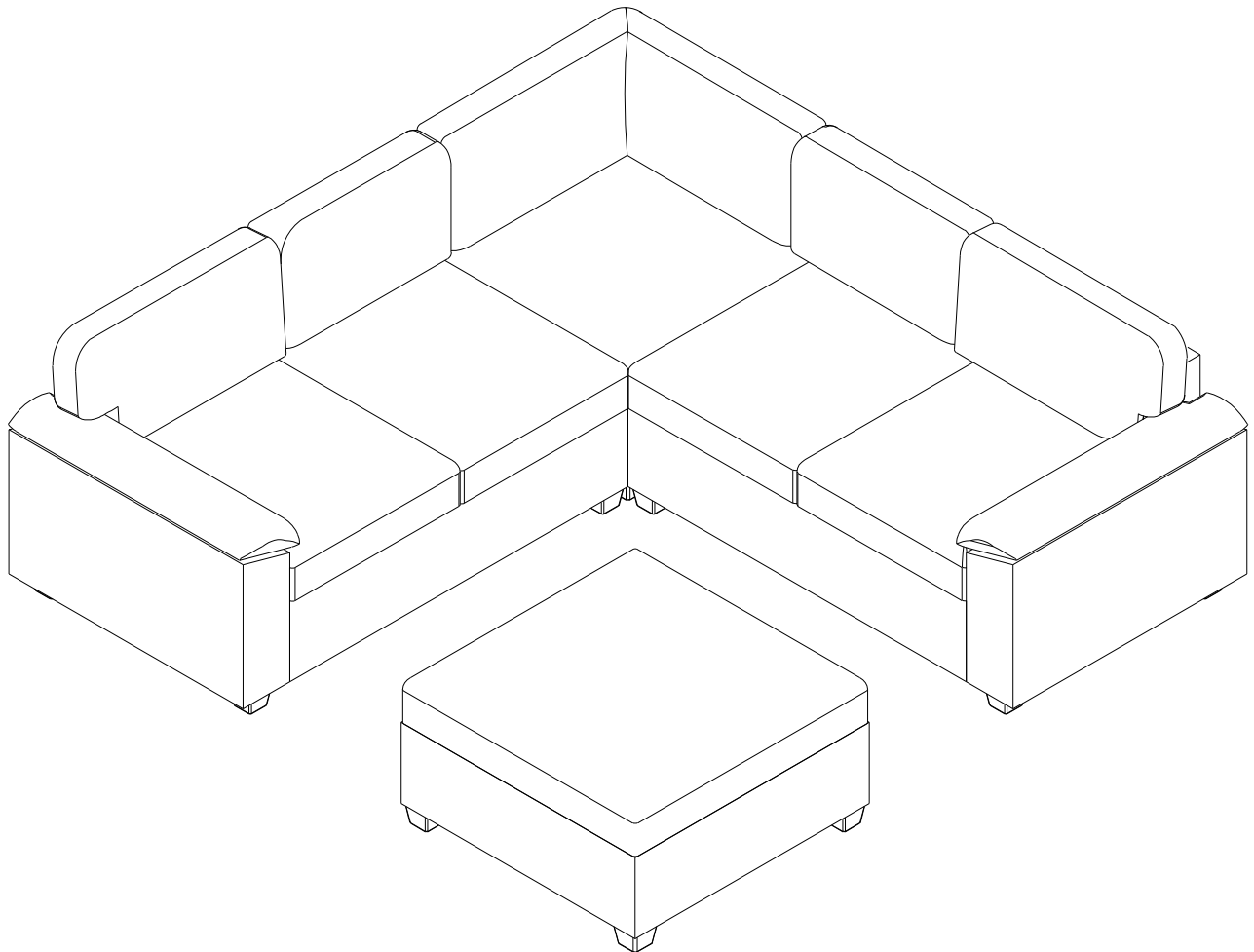



Return & Warranty policy:

- We strive to offer the highest quality products, and we also try our best to satisfy each and every customer that orders from us with replacement parts or service as needed.
- If the item is damaged or defective, please take photos as evidence for replacements and refunds.
- Please do not return to store, contact the seller if you have any troubles with this product.

ASSEMBLY INSTRUCTION

HARDWARE

NO	DESCRIPTION	SKETCH	QTY
1	Legs		16
2	Plastic Gasket		16
3	Plate Metal		8

PARTS LIST WF326272

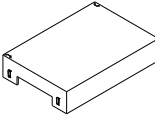
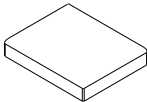
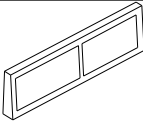
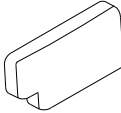
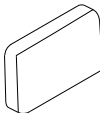
NO	DESCRIPTION	SKETCH	QTY
A	Left Loveseat Frame		1
B	Seat Cushion		2
C	Left Backrest Frame		1
D	Left Backrest Cushion		1
E	Left Middle Backrest Cushion		1

ASSEMBLY INSTRUCTION

PARTS LIST WF326273

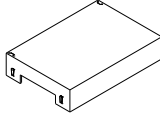
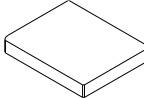
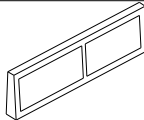
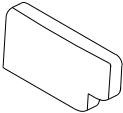
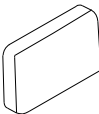
NO	DESCRIPTION	SKETCH	QTY
F	Right Loveseat Frame		1
B	Seat Cushion		2
H	Right Backrest Frame		1
I	Right Backrest Cushion		1
J	Right Middle Backrest Cushion		1

PARTS LIST WF326274

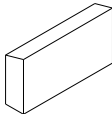
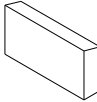
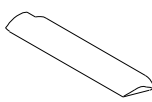
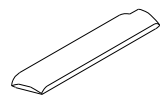
NO	DESCRIPTION	SKETCH	QTY
L	Right Armrest		1
M	Left Armrest		1
N	Right Armrest Cushion		1
O	Left Armrest Cushion		1

ASSEMBLY INSTRUCTION

PARTS LIST WF326275

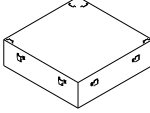
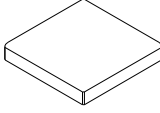
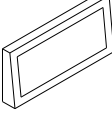
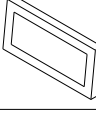
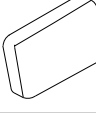
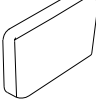
NO	DESCRIPTION	SKETCH	QTY
P	Corner Frame		1
Q	Corner Seat Cushion		1
R	Left Corner Backrest Frame		1
S	Right Corner Backrest Frame		1
T	Right Corner Backrest Cushion		1
U	Left Corner Backrest Cushion		1

PARTS LIST WF326276

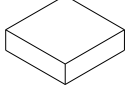
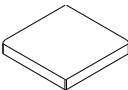
NO	DESCRIPTION	SKETCH	QTY
V	Ottoman Frame		1
K	Ottoman Cushion		1

ASSEMBLY INSTRUCTION

All parts and hardwares.

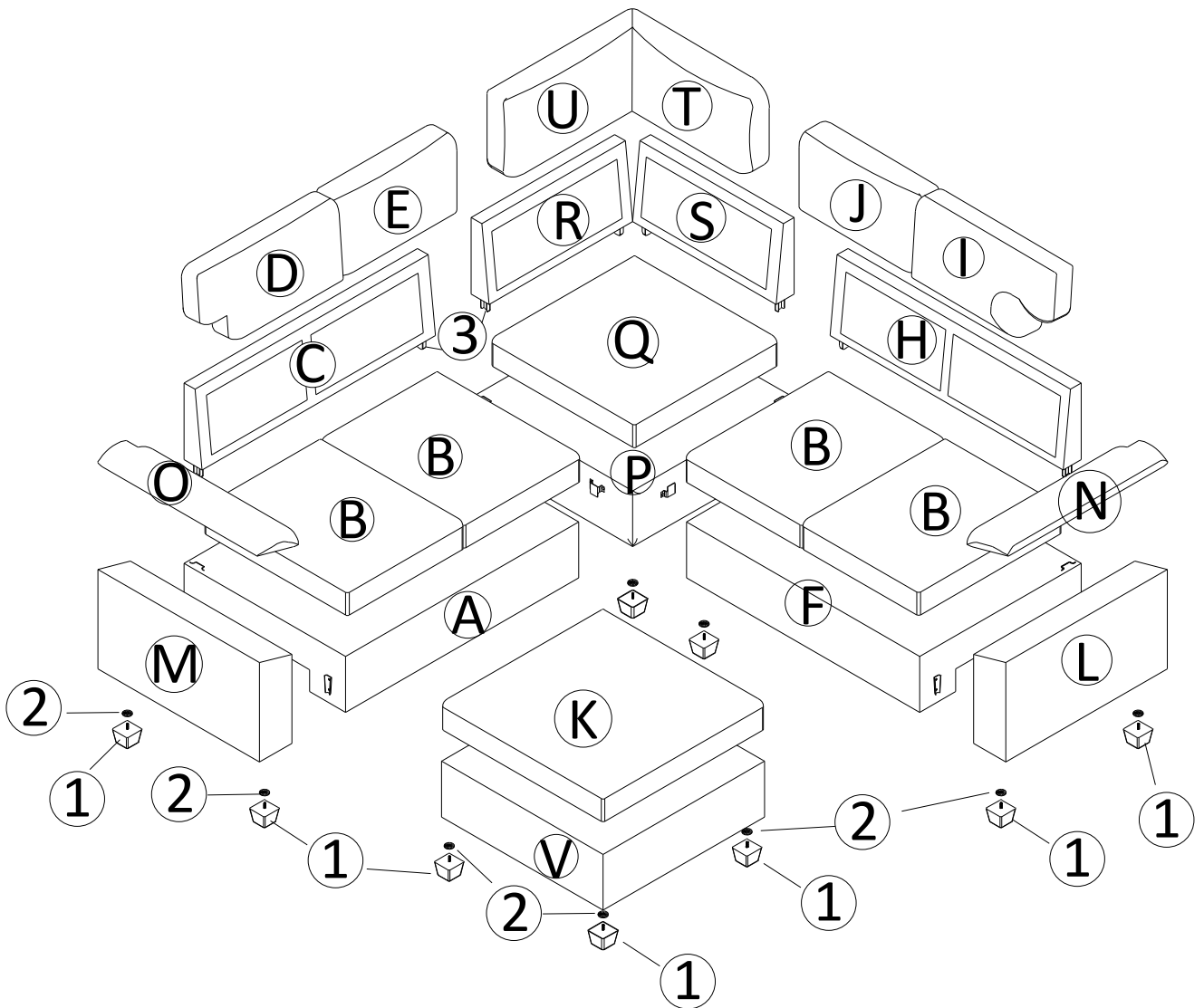
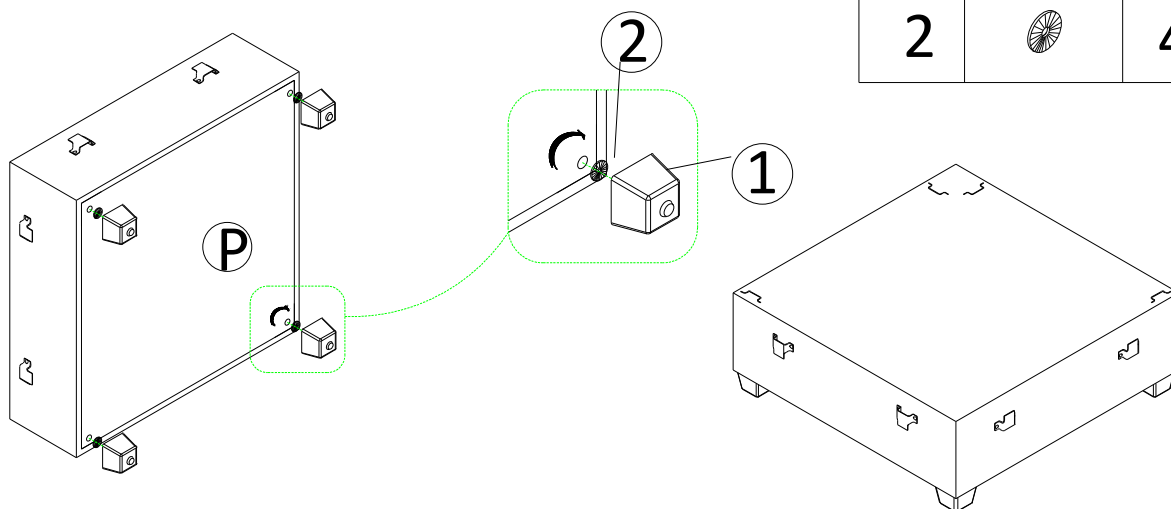

DIAGRAM 1 (Assemble the Legs)

Tighen 4 Legs(Hardware 1) by Plastic gaskets(Hardware 2).



1		4
2		4

DIAGRAM 2 (Assemble the Legs)

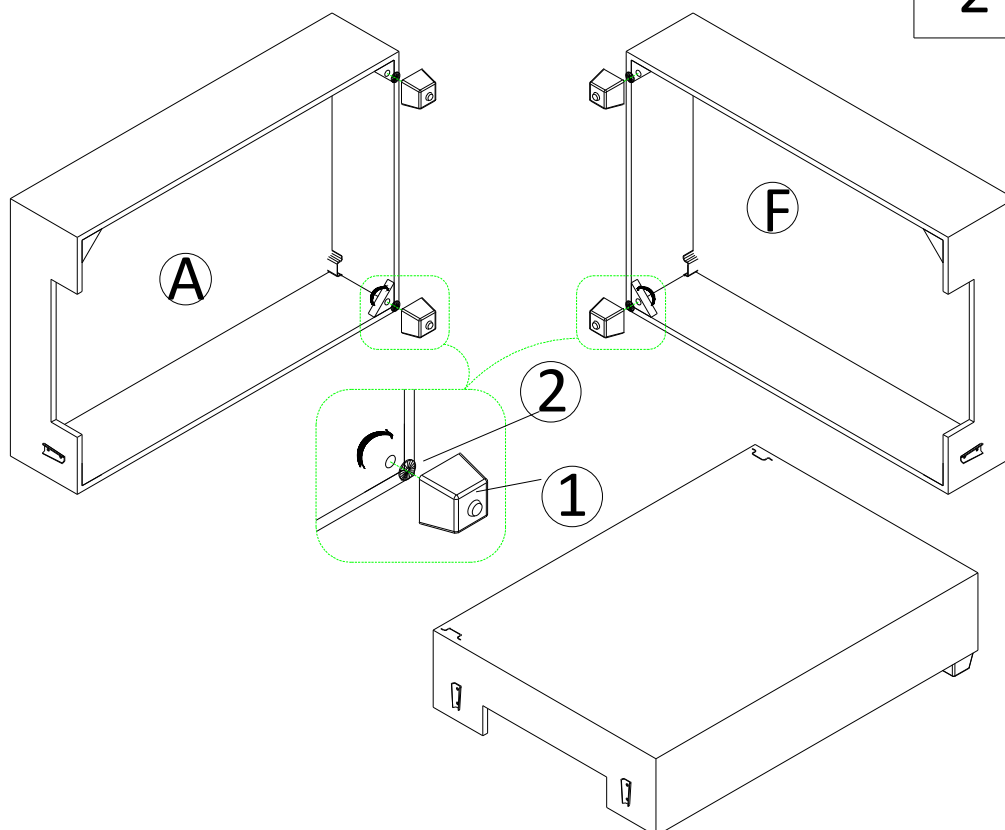

Tighen 8 Legs(Hardware 1) by Plastic gaskets (Hardware 2).



1		4
2		4

DIAGRAM 3 (Assemble the Legs)

Tighten 4 Legs(Hardware 1) by Plastic gaskets (Hardware 2).

1		4
2		4

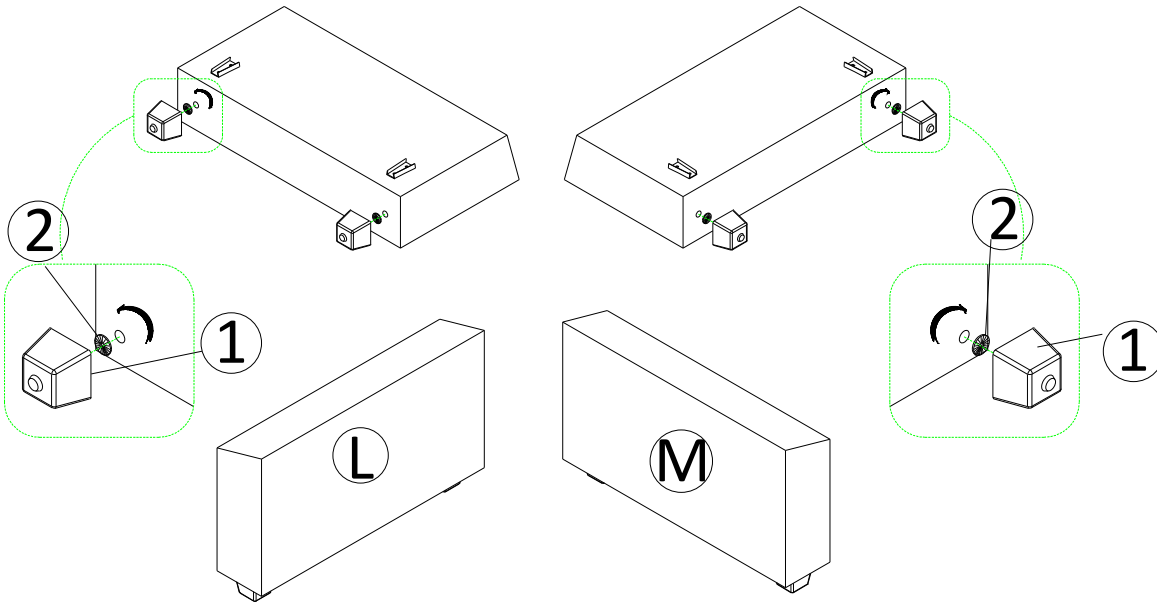

DIAGRAM 4 (Connecting the Seat Frames)

Connect the Left Armrest (Part M) to Left Loveseat Frame (Part A)

Connect the Left Loveseat Frame (Part A) to Corner Frame (Part P)

Connect the Right Armrest (Part L) to Right Loveseat Frame (Part F)

Connect the Right Loveseat Frame (Part F) to Corner Frame (Part P)

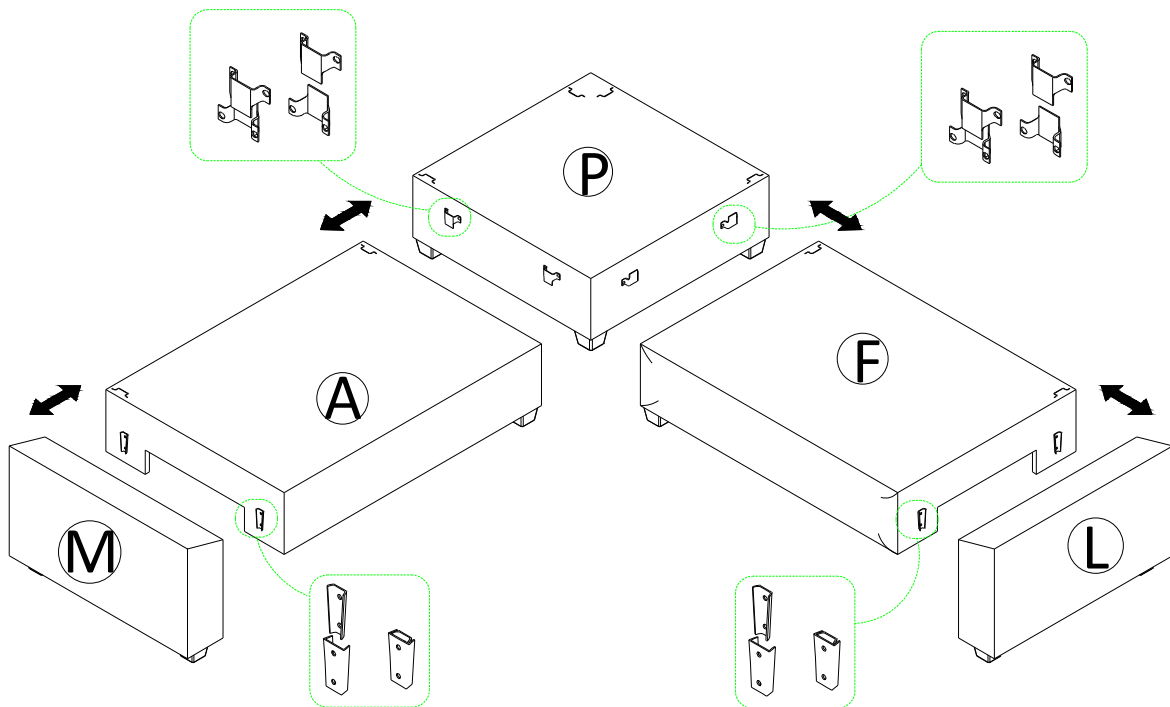



DIAGRAM 5 (Assemble the Legs)

Tighten 4 Legs(Hardware 1) by Plastic gaskets (Hardware 2).

1		4
2		4

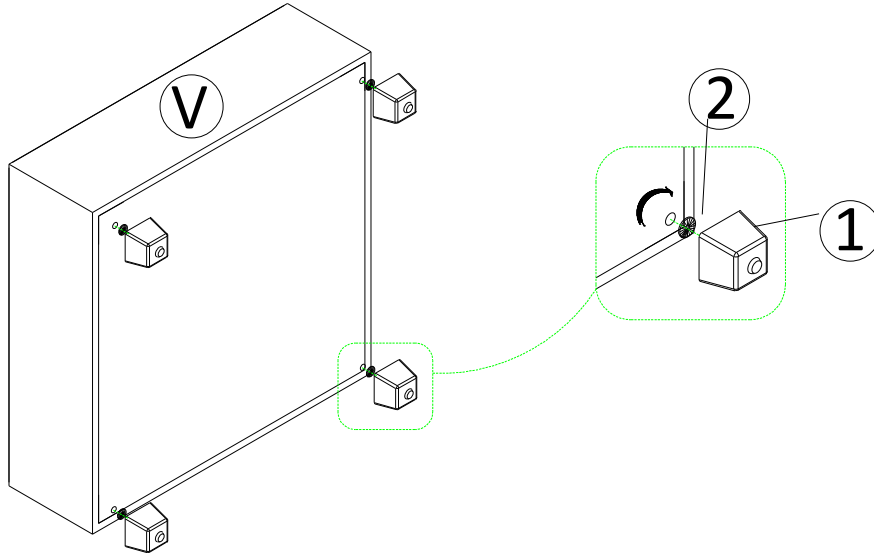
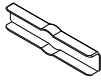

DIAGRAM 6 (Connecting back Plate metal) Put Plate metals(Hardware 3) into the Left Corner Backrest Frame (Part R)

3		2
---	---	---

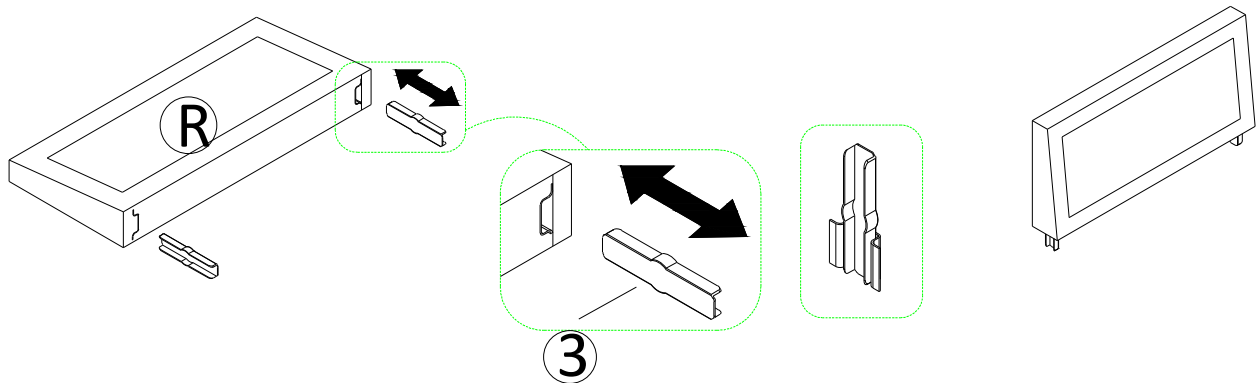
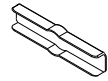

DIAGRAM 7 (Connecting back Plate metal)
Put Plate metals(Hardware 3) into the Right Corner
Backrest Frame (Part S)

3



2

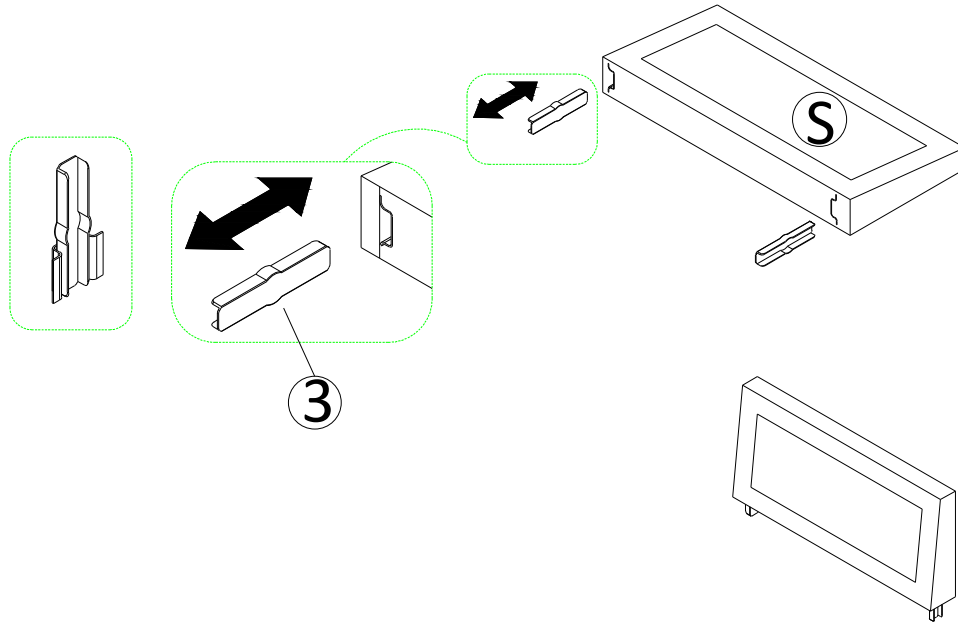
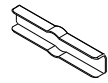

DIAGRAM 8 (Connecting back Plate metal)
Put Plate metals(Hardware 3) into the Backrest
Frame (Part C)(Part H)

3



4

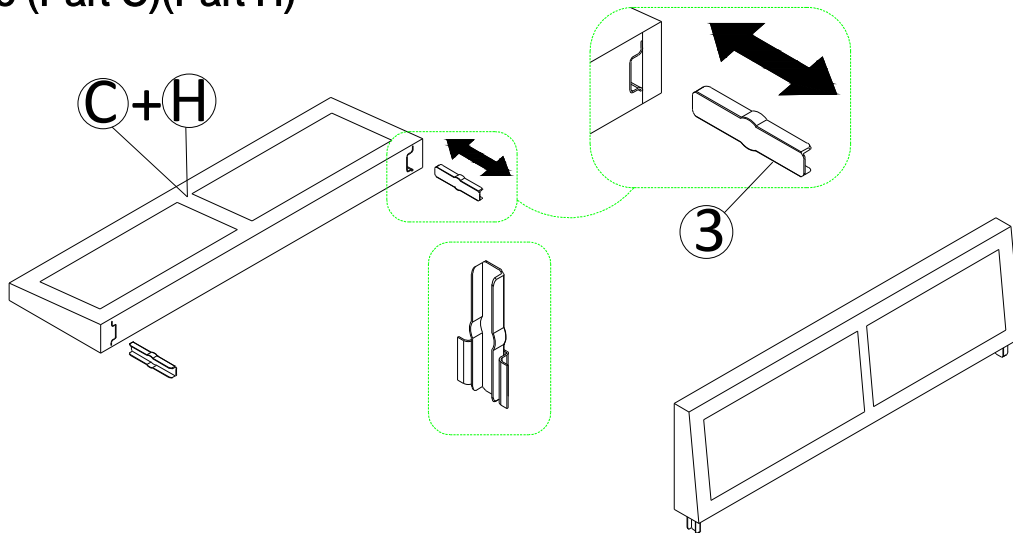

DIAGRAM 9 (Assemble the Backrest)
Connect backrests to seat frames.

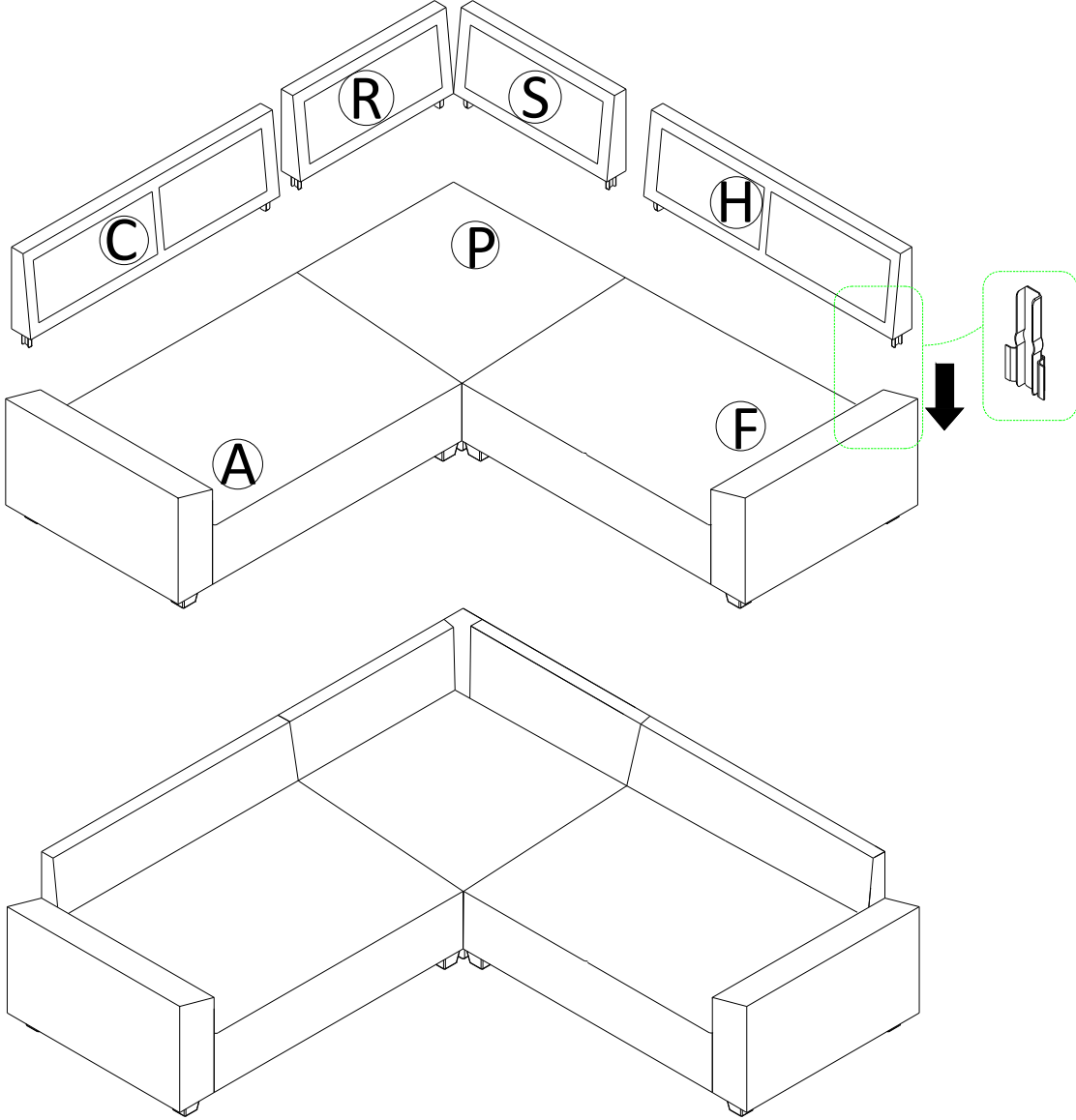
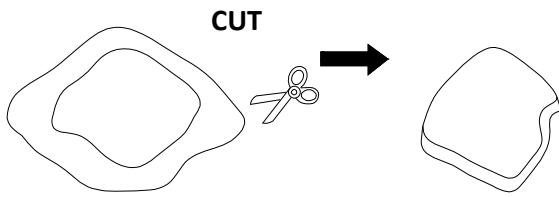
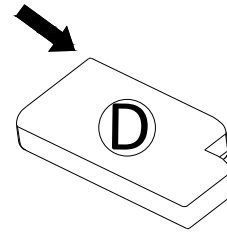

DIAGRAM 10 (Take out all cushions)



Pat around evenly plump



X1

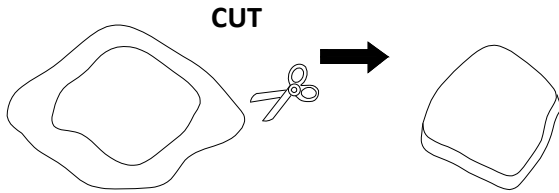

Pat around evenly plump

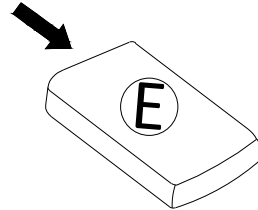

X1

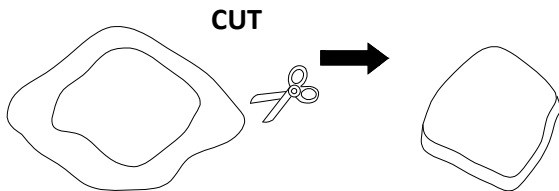

Pat around evenly plump

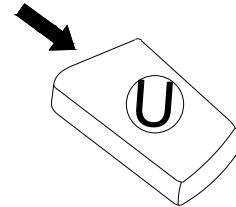

X1

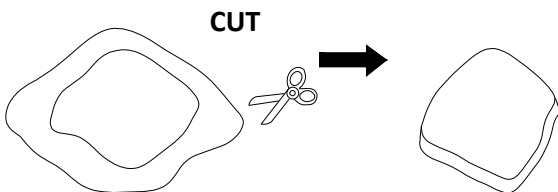

Pat around evenly plump

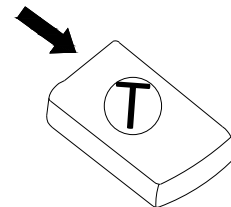

X1

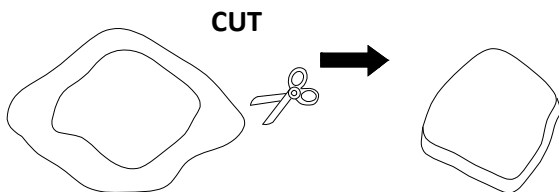

Pat around evenly plump

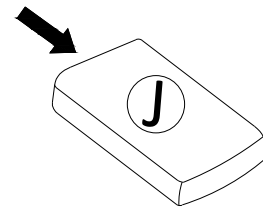

X1

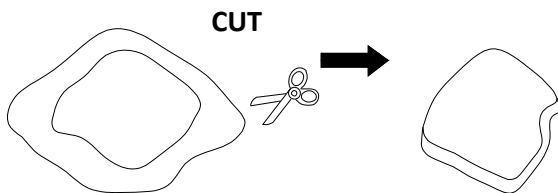

Pat around evenly plump

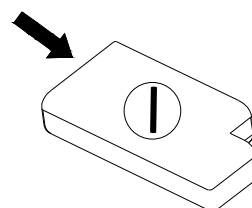

X1

DIAGRAM 11 (Take out all cushions)

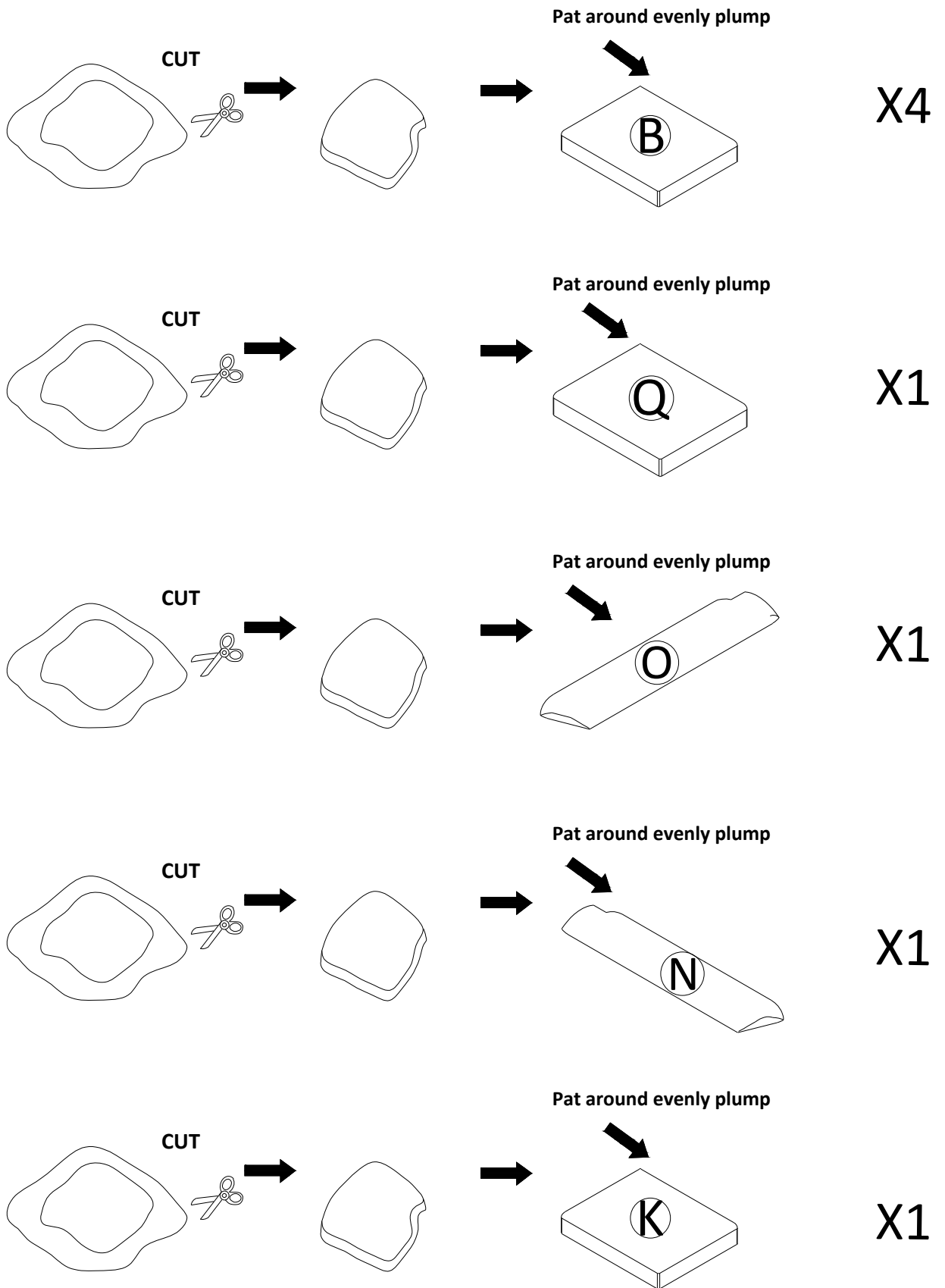
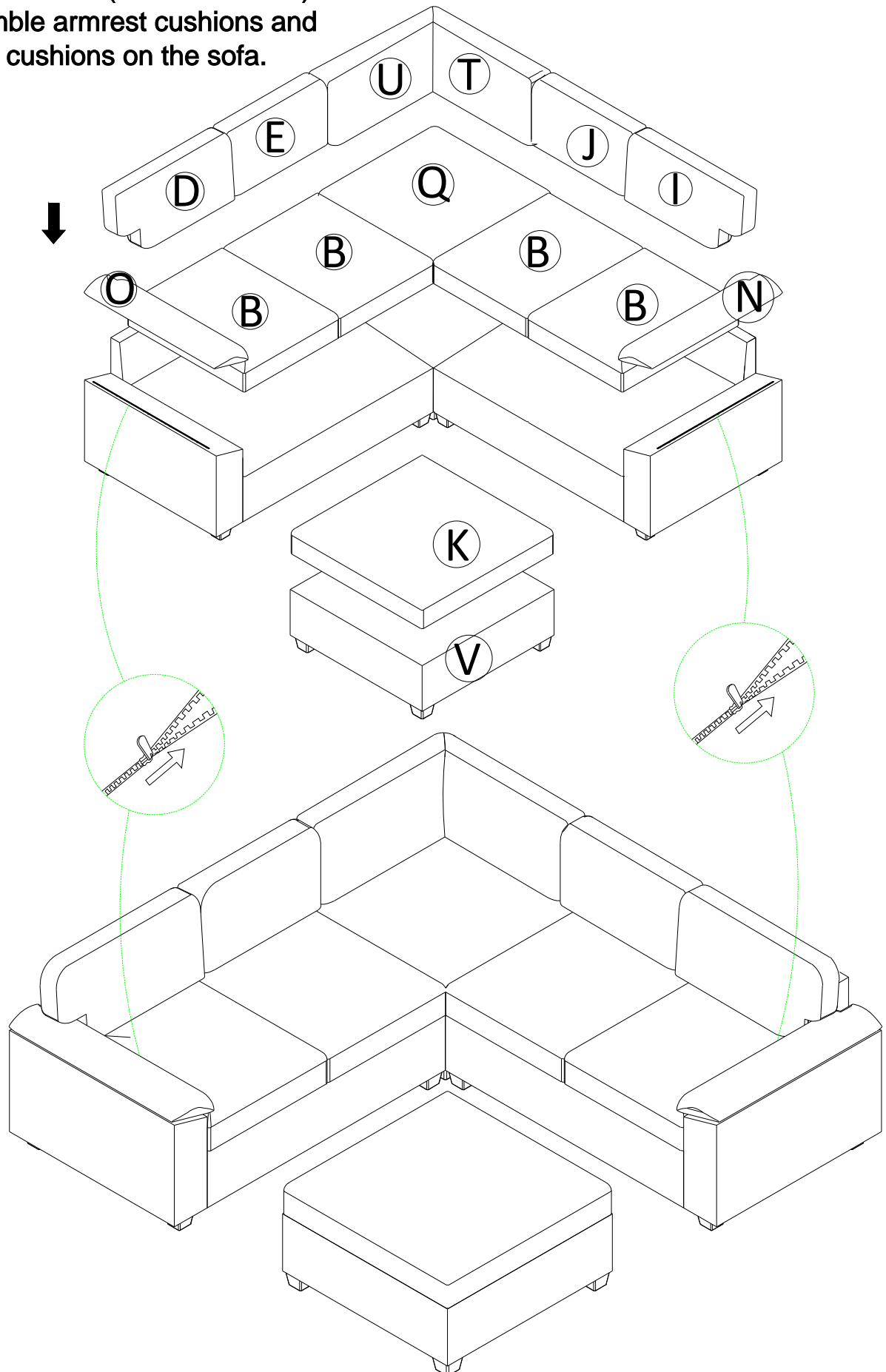
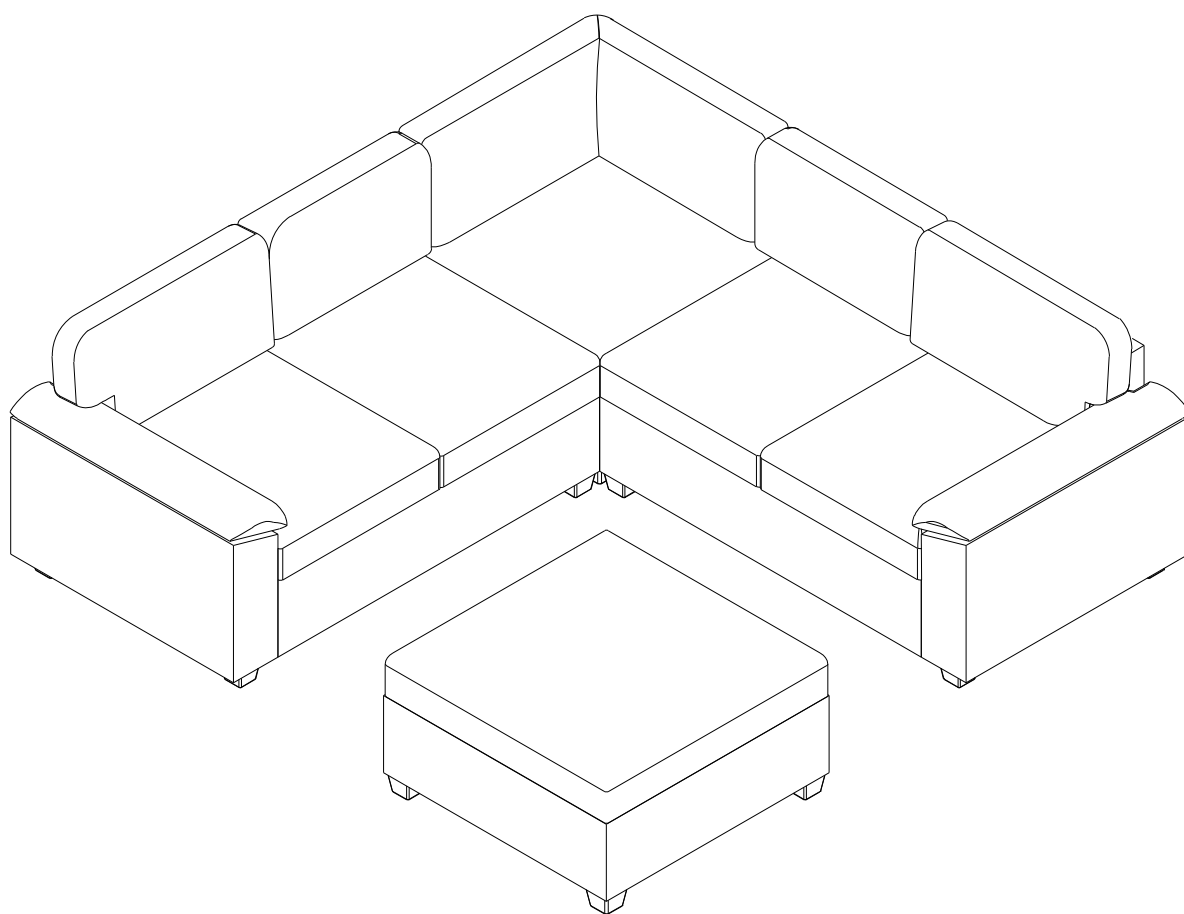

DIAGRAM 12 (Place cushions)
Assemble armrest cushions and
put all cushions on the sofa.



TIPS

1. Please do not open the compressed packages until your sofa frame is completely assembled.
2. Compressed back cushions and pillows need to be fully fulfilled within 72 hours for your perfect use.
3. Please keep children away from plastic bags or any small pieces of stuff.



Complete