

ASSEMBLY INSTRUCTION

WF322215

WF322216

WF322217

Friendly Reminder:

- 1.This sofa is packed in 3 boxes. Please assemble it After all boxes are received.
- 2.As the cushions are all vacuum compressed,there will be some wrinkles. Please give your cushions up to 72 hours to reach its original size and the wrinkles will basically disappear.
- 3.Please do not open the compressed packages until your sofa frame is completely assembled.

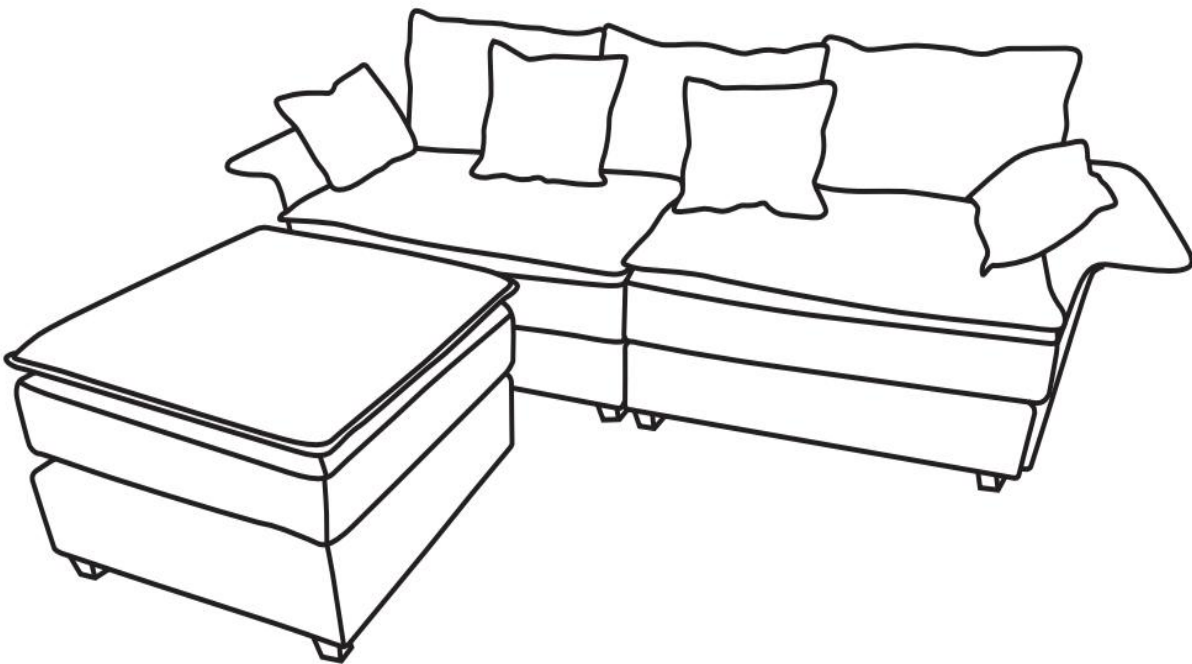







Return & warranty policy



- we strive to offer the highest quality products , and we also try our best to satisfy each and every customer that orders from us with replacement parts or service as needed.
- If the item is damaged or defective , please take photos as evidence for replacements and refunds.
- please do not return to store , contact the seller if you have any troubles with this product.

ASSEMBLY INSTRUCTION

HARDWARE WF322215



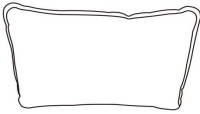
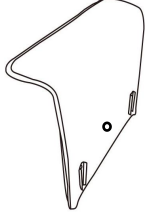
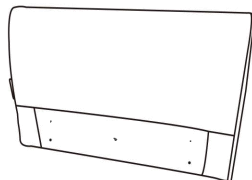
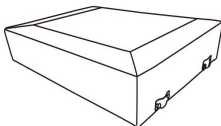
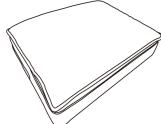



NO	DESCRIPTION	SKETCH	QTY
1	Plastic gasket		4
2	Felt mat		4
3	Bolt M8*45		5
4	Bolt M6*45		1
5	Spring washer 8*13		5
6	Flat washer 8*22		6
7	Allen key		1

PART LIST WF322215





NO	DESCRIPTION	SKETCH	QTY
A	Main leg		4
B	Backrest pillow		1
C	Armrest		1
D	Backrest		1
E	Left seat frame		1
F	Seat cushion		1
G	Armrest pillow		1

ASSEMBLY INSTRUCTION

HARDWARE WF322216

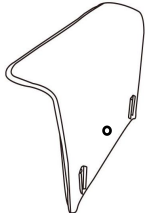
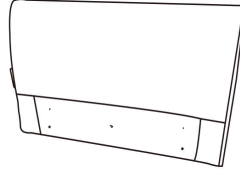
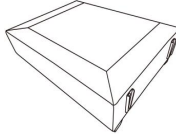
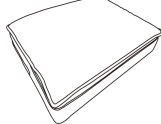

NO	DESCRIPTION	SKETCH	QTY
1	Plastic gasket		4
2	Felt mat		4
3	Bolt M8*45		5
4	Bolt M6*45		1
5	Spring washer 8*13		5
6	Flat washer 8*22		6
7	Allen key		1

PART LIST WF322216

NO	DESCRIPTION	SKETCH	QTY
A	Main leg		4
H	Square pillow		2
C	Armrest		1
D	Backrest		1
I	Right seat frame		1
F	Seat cushion		1
G	Armrest pillow		1

ASSEMBLY INSTRUCTION

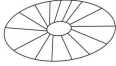
HARDWARE WF322217

NO	DESCRIPTION	SKETCH	QTY
1	Plastic gasket		4
2	Felt mat		4

PART LIST WF322217

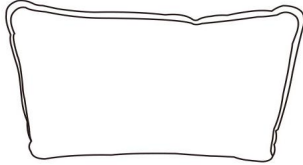
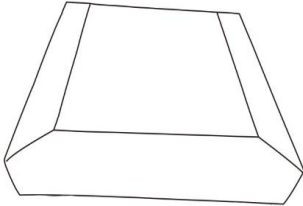
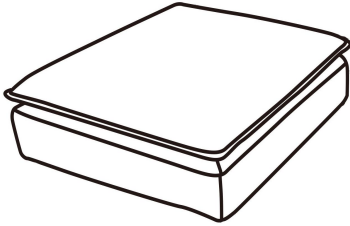
NO	DESCRIPTION	SKETCH	QTY
A	Main leg		4
B	Backrest pillow		2
J	Ottoman seat frame		1
K	Ottoman seat cushion		1

ASSEMBLY INSTRUCTION

All parts and hardwares

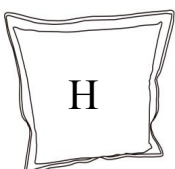
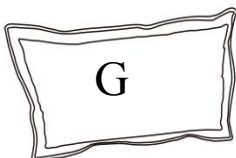
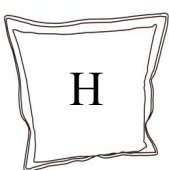
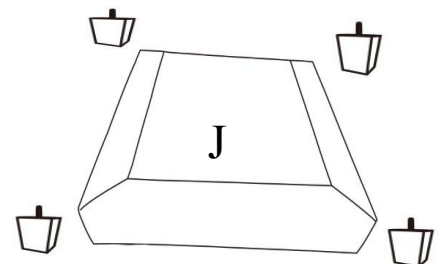
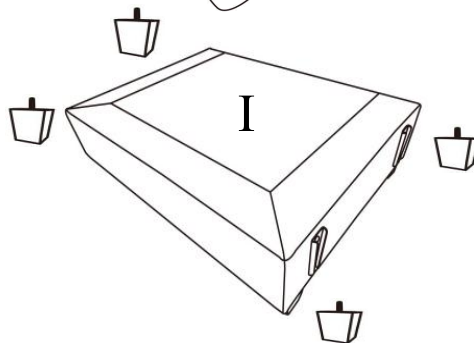
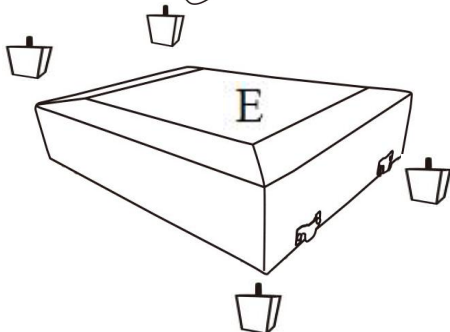
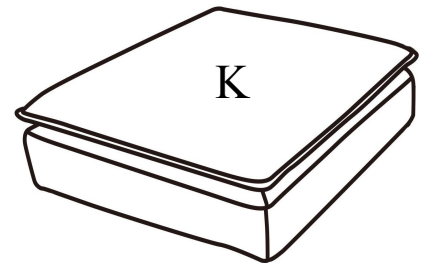
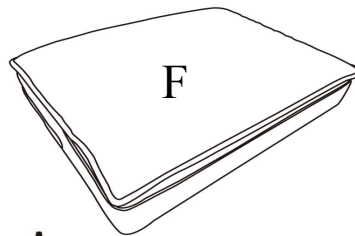
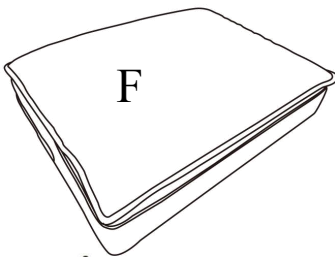
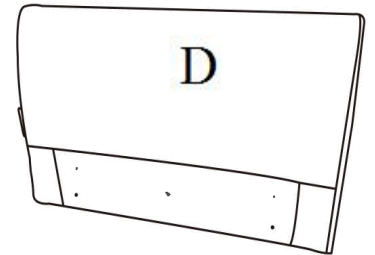
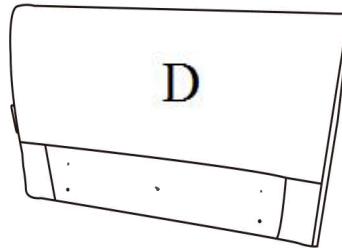
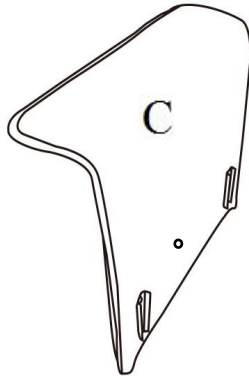
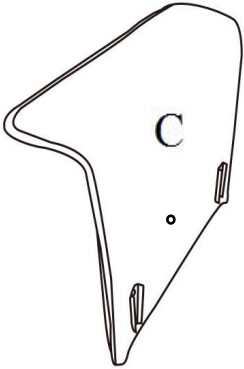
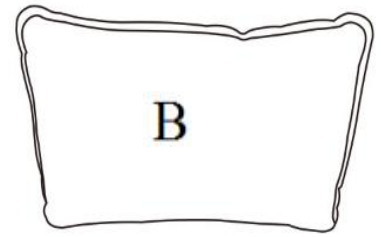
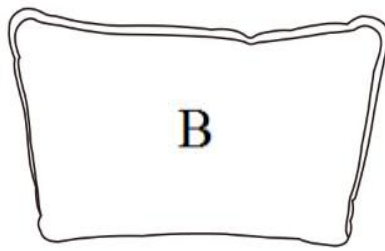
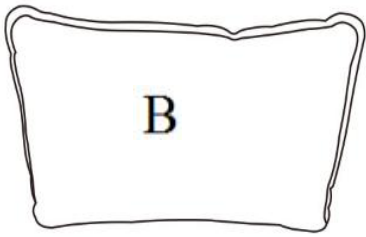

1		12
2		12
3		10
4		2
5		10
6		12
7		2

ASSEMBLY INSTRUCTION

WF322215

DIAGRAM 1 (Take out all parts from carton WF322215)

Take the Main legs (Part A), Backrest pillow (Part B), Armrest (Part C), Seat cushion (Part F), Armrest pillows (Part G) out of the Left seat frame (Part E).

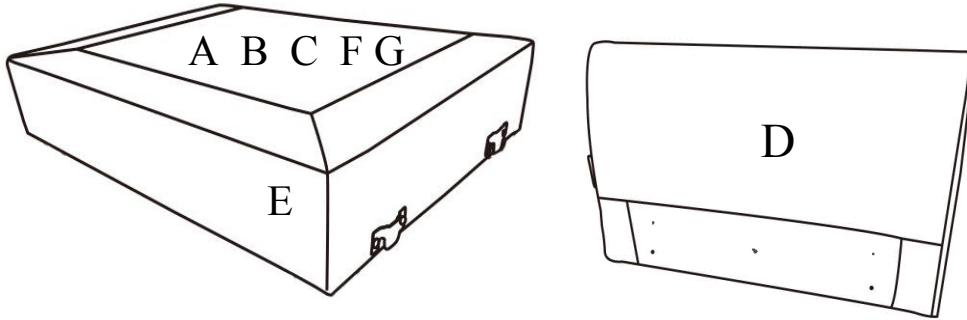







①		4
②		4
③		5
④		1
⑤		5
⑥		6
⑦		1

DIAGRAM 2 (Assemble the Backrest and the Armrest)

Insert the Armrest (Part C) to the Left seat frame (Part E) like below picture .





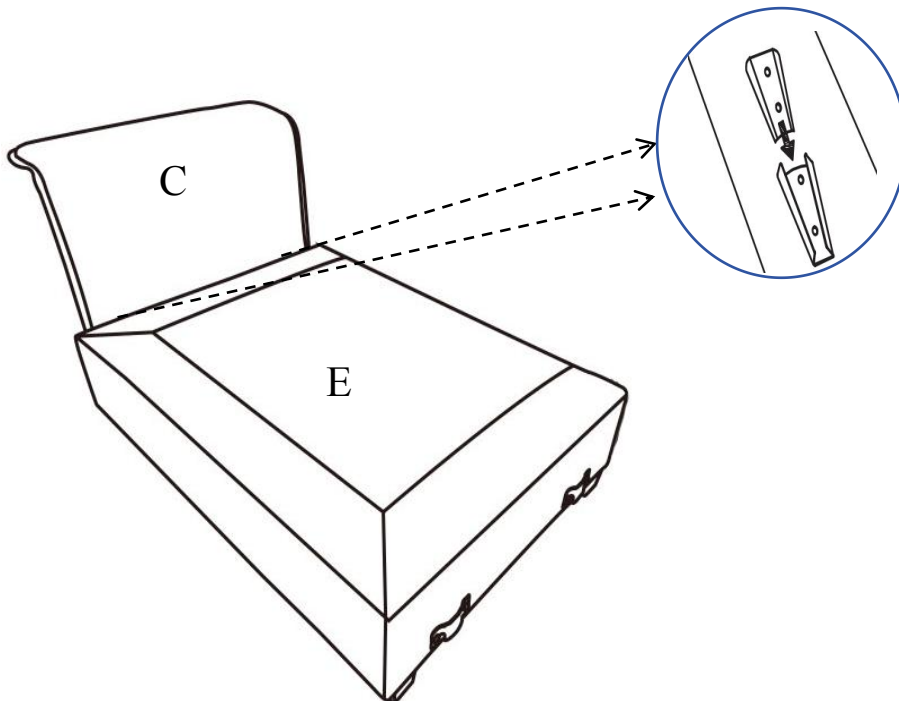

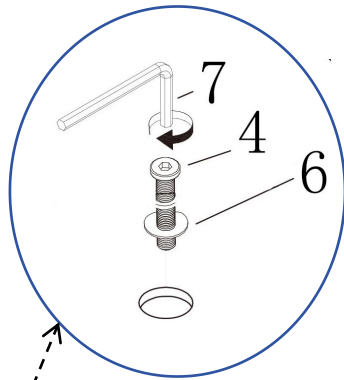

ASSEMBLY INSTRUCTION

WF322215

DIAGRAM 3 (Assemble the Backrest and the Armrest)

First use the Allen key (Hardware 7) like below picture, put the Flat washers (Hardware 6) into the Bolts M6*45 (Hardware 4). And then put the Spring washers (Hardware 5) on top of the Flat washers (Hardware 6) and then put all into the Bolts M8*45 (Hardware 3). Don't screw any bolt all in until the others are all put into the holes. To ensure the good looking of the sofa, remember to keep the bottom of the frame align. Tight all the bolts.



③		5
④		1
⑤		5
⑥		6
⑦		1

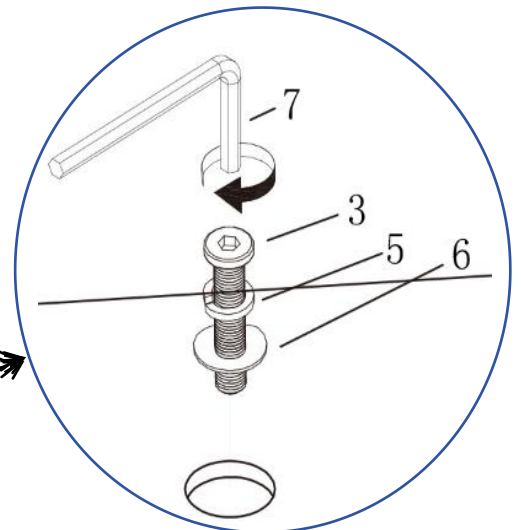
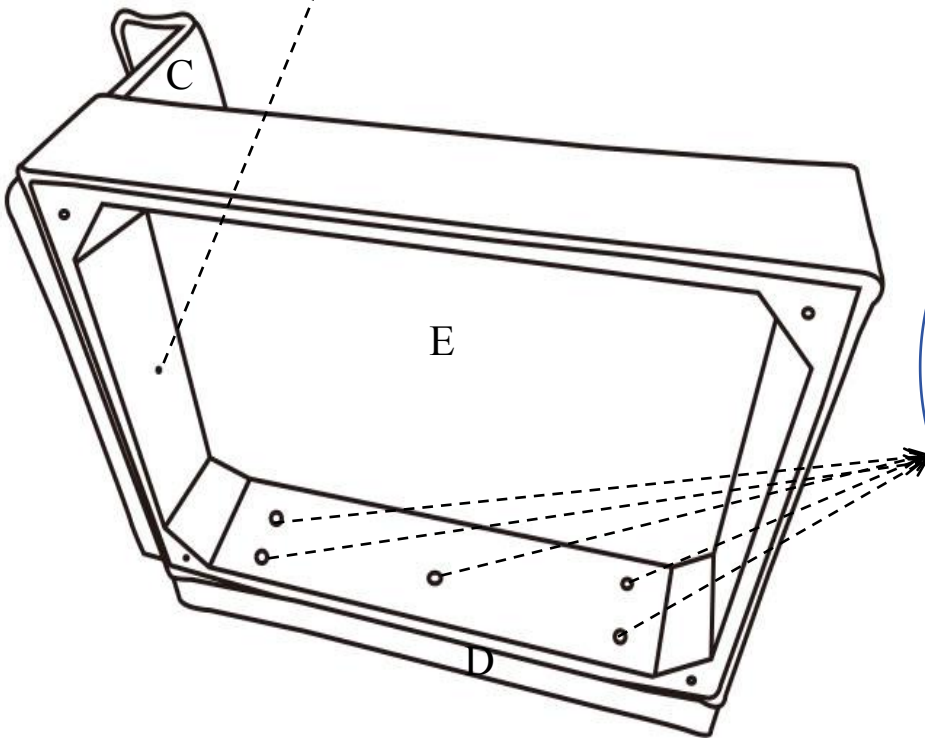

ASSEMBLY INSTRUCTION

WF322215

DIAGRAM 4

Use scissors to open the vacuum sealed Seat cushion (Part F). It may take 24-72 hours to fully expand back to its original shape and firmness.

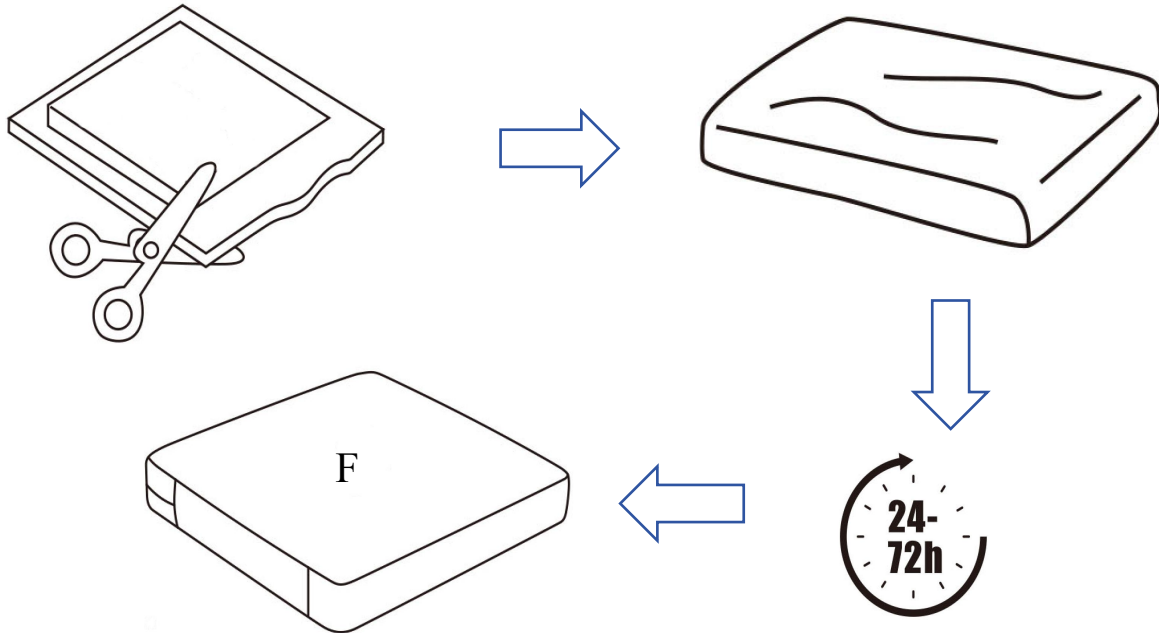
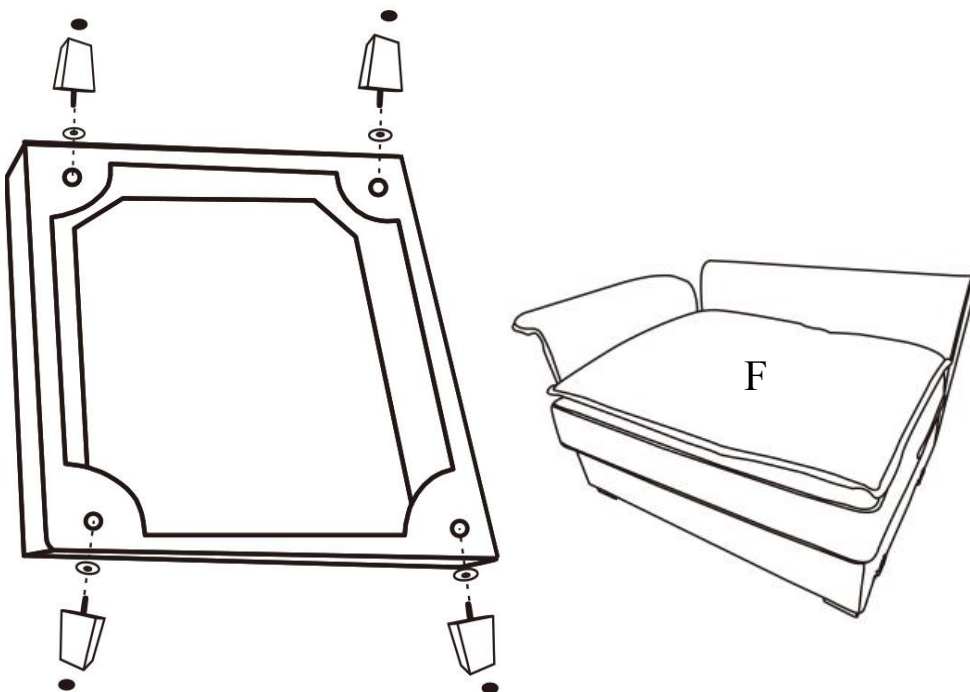
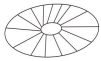



DIAGRAM 5

Tighten Main legs (Part A) by 4 Plastic gaskets (Hardware 1) . And then stick the 4 Felt mats (Hardware 2) under the Main legs (Part A). Put the Seat cushion (Part F) on the seat.



①		4
②		4
A		4

ASSEMBLY INSTRUCTION

WF322216

DIAGRAM 1 (Take out all parts from carton WF322216)

Take the Main legs (Part A), Square pillows (Part H), Armrest (Part C), Seat cushion (Part F), Armrest pillows (Part G) out of the Right seat frame (Part I).

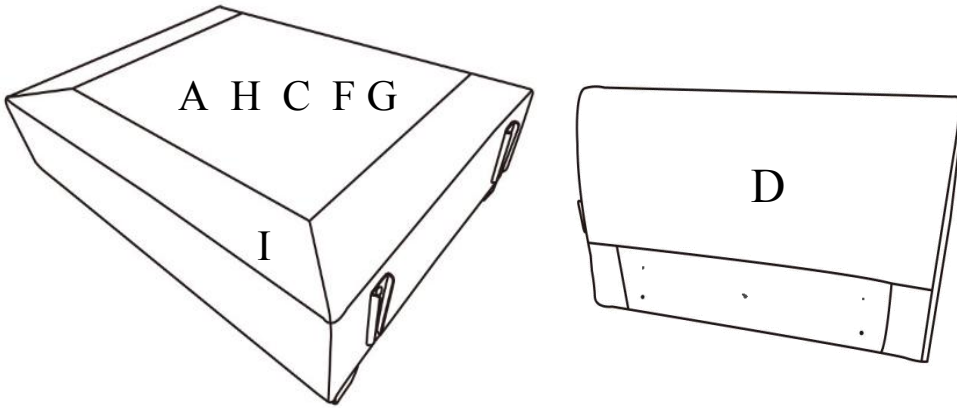







①		4
②		4
③		5
④		1
⑤		5
⑥		6
⑦		1

DIAGRAM 2 (Assemble the Backrest and the Armrest)

Insert the Armrest (Part C) to the Right seat frame (Part I) like below picture .

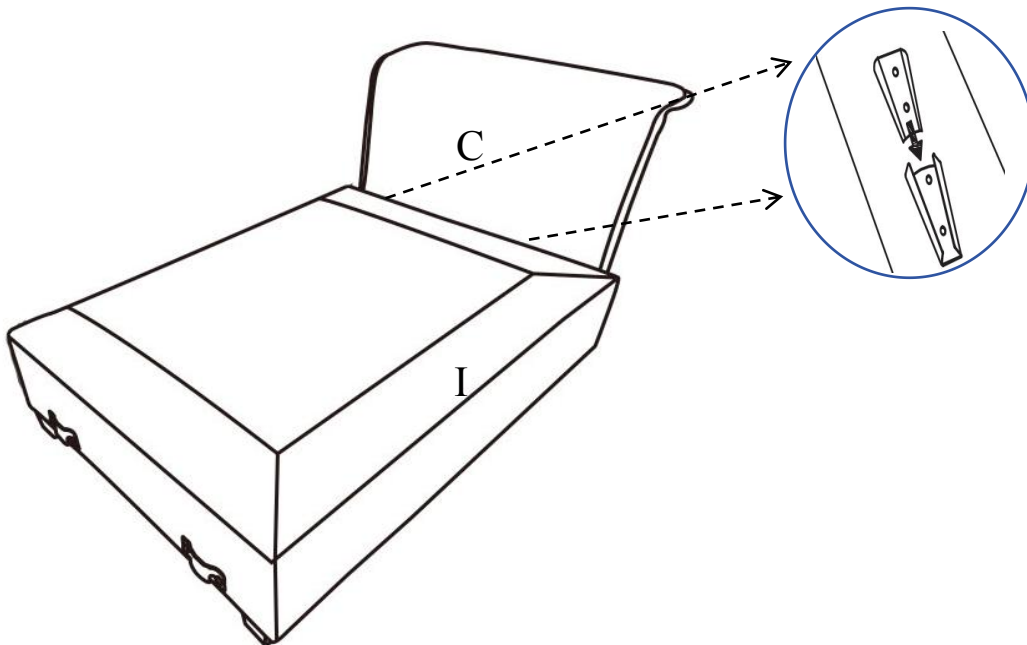

ASSEMBLY INSTRUCTION

WF322216

DIAGRAM 3 (Assemble the Backrest and the Armrest)

First use the Allen key (Hardware 7) like below picture, put the Flat washers (Hardware 6) into the Bolts M6*45 (Hardware 4). And then put the Spring washers (Hardware 5) on top of the Flat washers (Hardware 6) and then put all into the Bolts M8*45 (Hardware 3). Don't screw any bolt all in until the others are all put into the holes. To ensure the good looking of the sofa, remember to keep the bottom of the frame align. Tight all the bolts.

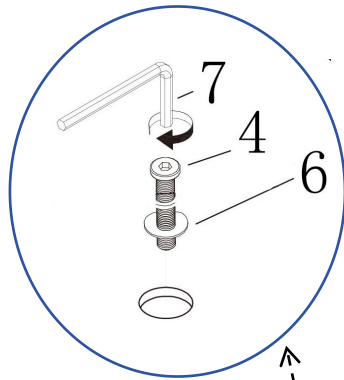

③		5
④		1
⑤		5
⑥		6
⑦		1

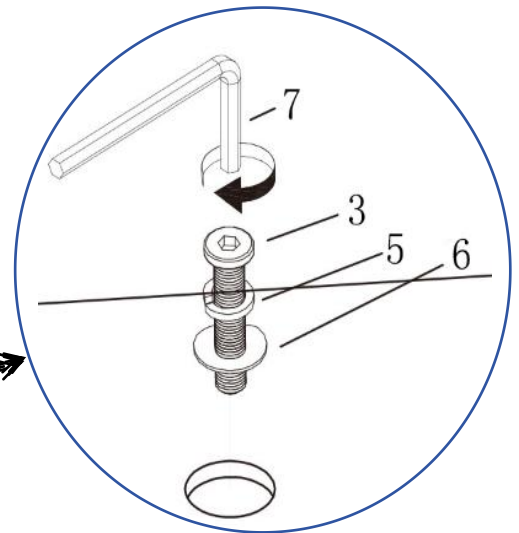
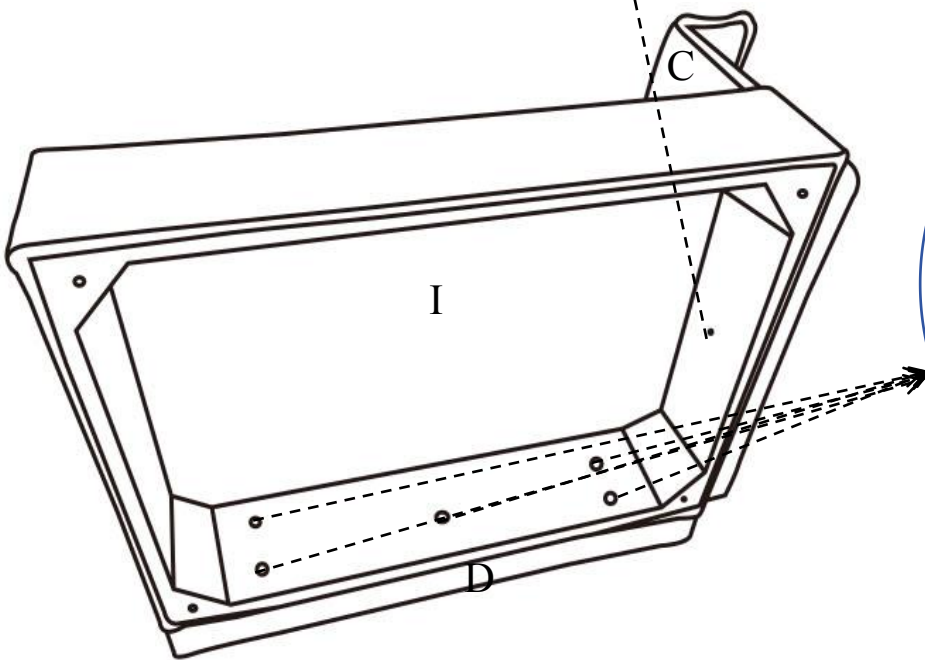

ASSEMBLY INSTRUCTION

WF322216

DIAGRAM 4

Use scissors to open the vacuum sealed Seat cushion (Part F). It may take 24-72 hours to fully expand back to its original shape and firmness.

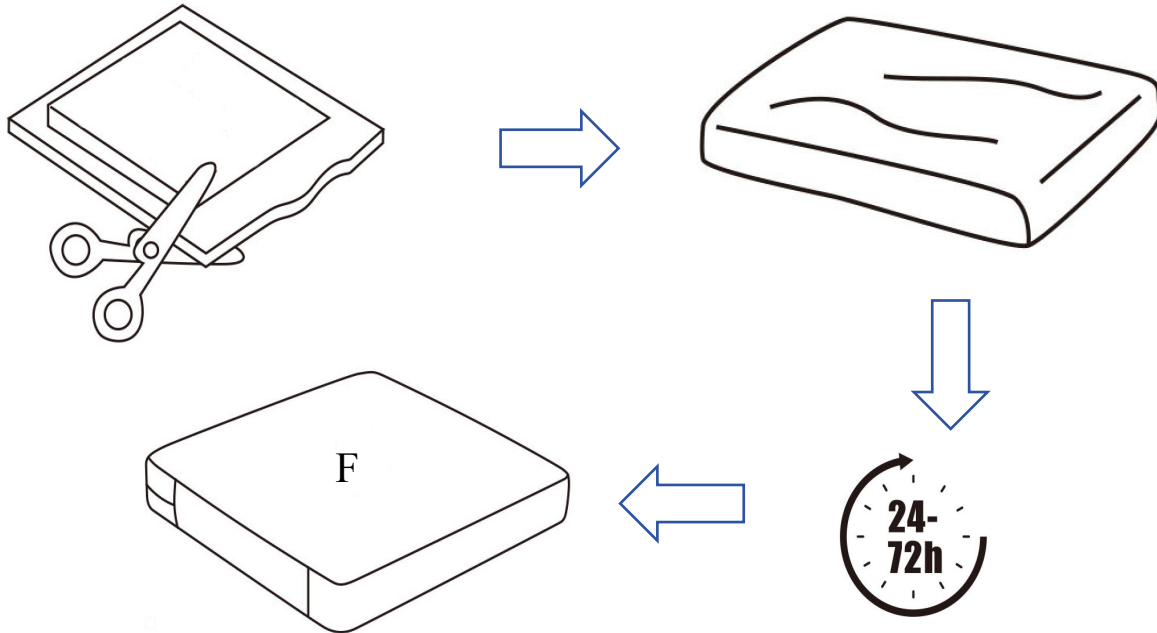
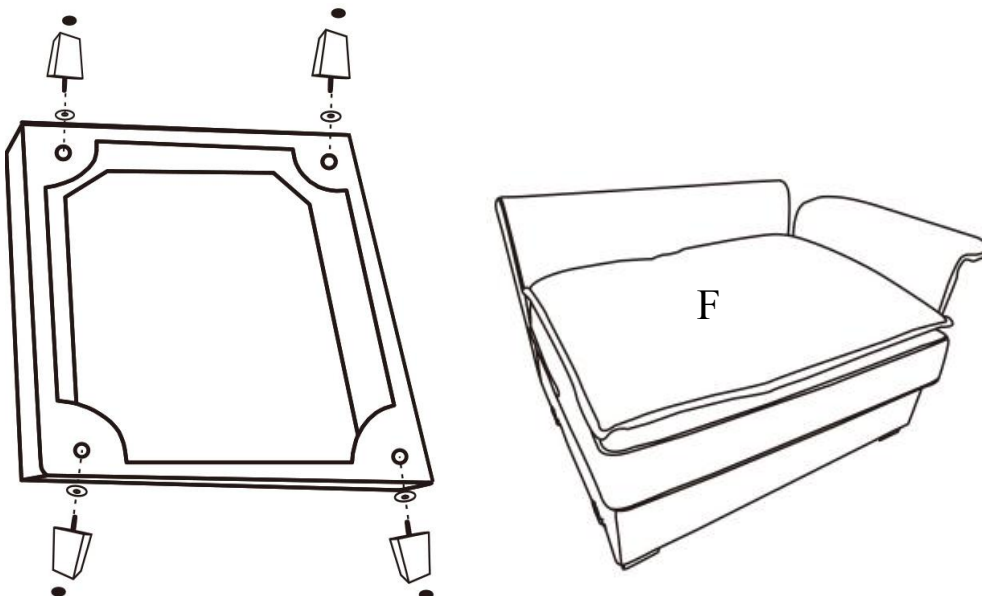
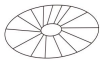



DIAGRAM 5

Tighten Main legs (Part A) by 4 Plastic gaskets (Hardware 1) . And then stick the 4 Felt mats (Hardware 2) under the Main legs (Part A). Put the Seat cushion (Part F) on the seat.



①		4
②		4
A		4

ASSEMBLY INSTRUCTION

WF322217

DIAGRAM 1 (Take out all parts from carton WF322217)

Take the Main legs (Part A), Backrest pillows (Part B), Ottoman seat cushion (Part K) out of the Ottoman seat frame (Part J).

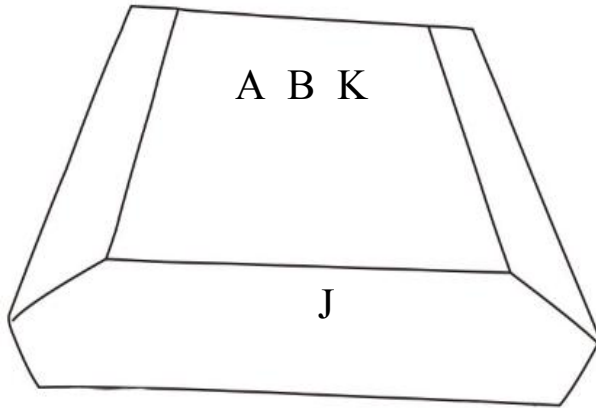



①		4
②		4

DIAGRAM 2

Use scissors to open the vacuum sealed Ottoman seat cushion (Part K). It may take 24-72 hours to fully expand back to its original shape and firmness.

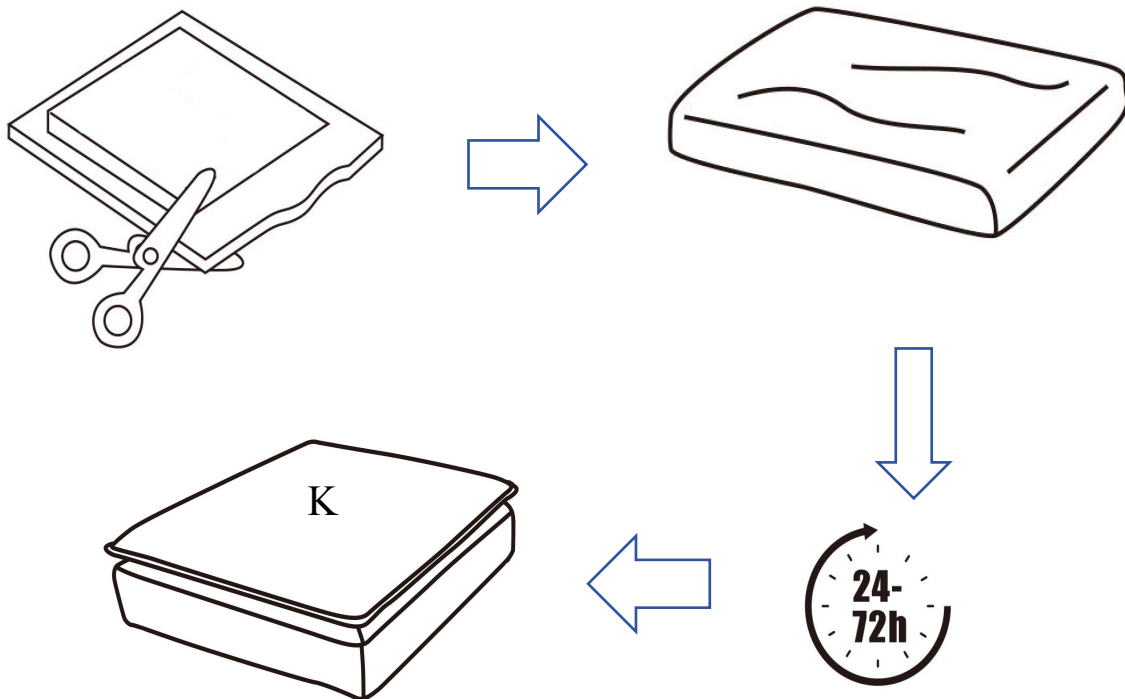

ASSEMBLY INSTRUCTION

WF322217

DIAGRAM 3

Tighten Main legs (Part A) by 4 Plastic gaskets (Hardware 1) . And then stick the 4 Felt mats (Hardware 2) under the Main legs (Part A). Put the Seat cushion (Part K) on the seat.

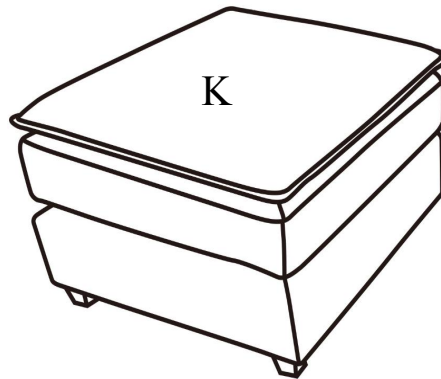
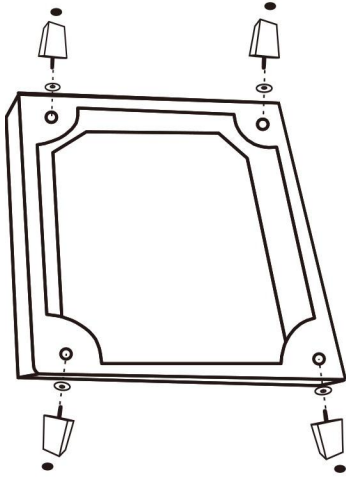

①		4
②		4
A		4

DIAGRAM 4

Connect the Left seat frame (Part E) and the Right seat frame (Part I) like below picture.

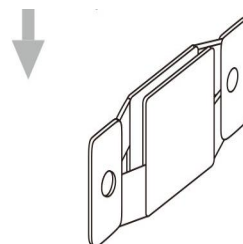
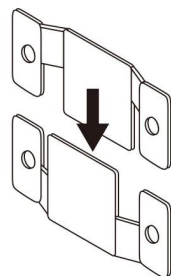
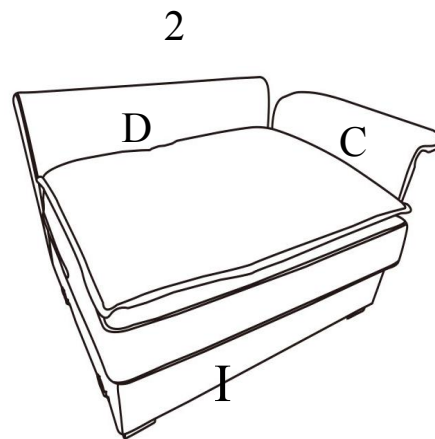
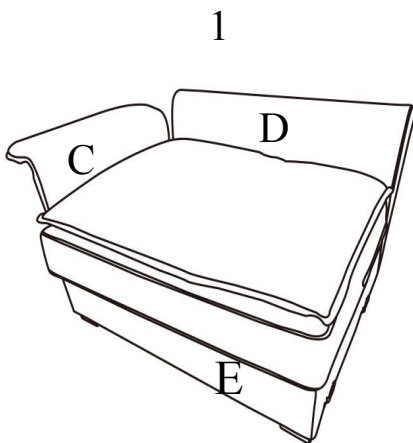



Connection mode:
1 is attached to 2

ASSEMBLY INSTRUCTION

WF322217

DIAGRAM 5

Put the Backrest pillows (Part B) , Armrest pillows (Part G) and the Square pillows (Part H) to the sofa.

B		3
G		2
H		2

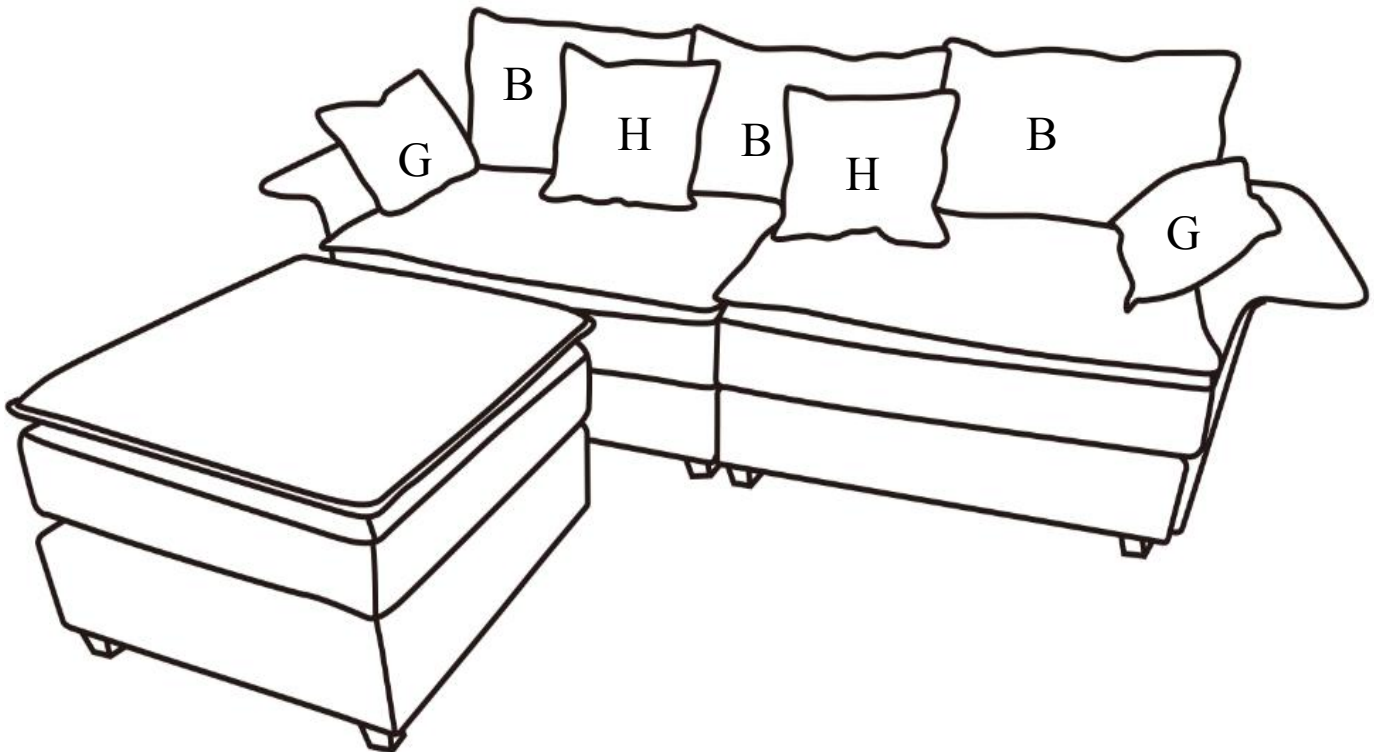

ASSEMBLY INSTRUCTION

TIPS:

1. Please do not open the compress packaging until your sofa frame is completely assembled.
2. Compress back cushions and pillows need to be fully fulfilled within 72 hours for your perfect use.
3. Please keep children away from plastic bags or any small pieces of stuff.

