

ASSEMBLY INSTRUCTION

WF310168
WF310170

WF310169

Friendly Reminder:

- 1.This sofa is packed in 3 boxes.Please assemble it After all boxes are received.
- 2.As the cushions are all vacuum compressed,there will be some wrinkles.Please give your cushions up to 72 hours to reach its original size and the wrinkles will basically disappear.
- 3.Please do not open the compressed packages until your sofa frame is completely assembled.

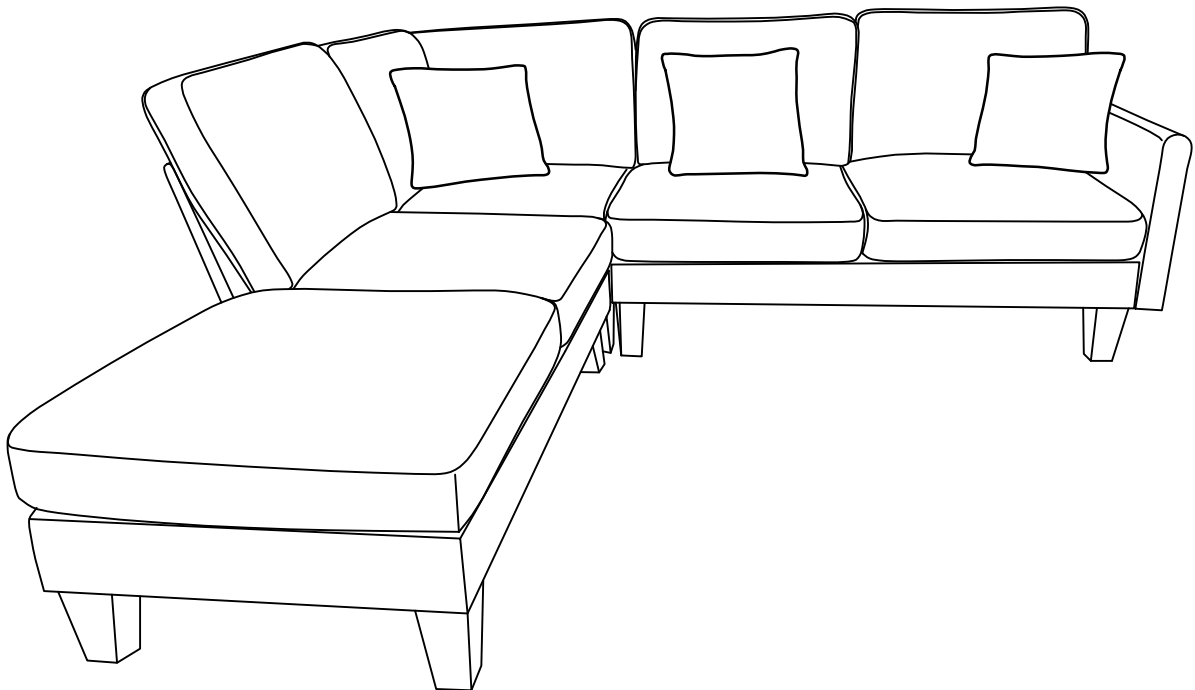







Return & Warranty policy:

- We strive to offer the highest quality products,and we also try our best to satisfy each and every customer that orders from us with replacement parts or service as needed.
- If the item is damaged or defective, please take photos as evidence for replacements and refunds.
- Please do not return to store,contact the seller if you have any troubles with this product.







ASSEMBLY INSTRUCTION

HARDWARE

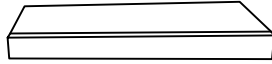
NO	DESCRIPTION	SKETCH	QTY
1	Washer		28
2	Screws 8X60		24
3	Screws 8X80		2
4	Butterfly nut		2
5	Wrench		1
6	Plastic gasket		12

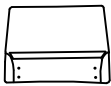
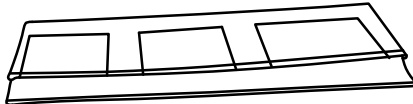

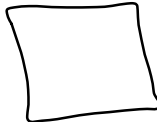



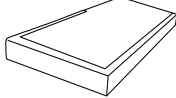

ASSEMBLY INSTRUCTION

PARTS LIST WF310168

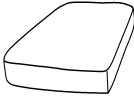
NO	DESCRIPTION	SKETCH	QTY
A	Seat frame		1
F	Seat cushion		2
H	Back frame		2
J	Back cover (long)		1
K	Back cushion		2
O	Pillow		1
P	Leg		4

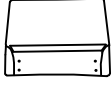

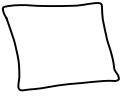



ASSEMBLY INSTRUCTION

PARTS LIST WF310169

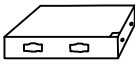
NO	DESCRIPTION	SKETCH	QTY
B	Chaise frame		1
D	Armrest		1
E	Chaise cushion		1
F	Seat cushion		1
H	Back frame		1
I	Back cover (short)		1
K	Back cushion		1
O	Pillow		1
P	Leg		4

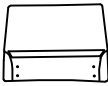
ASSEMBLY INSTRUCTION

PARTS LIST WF310170

NO	DESCRIPTION	SKETCH	QTY
C	Corner seat frame		1
G	Corner seat cushion		1
H	Back frame		2
L	Corner back cushion (Left)		1
M	Corner back cushion (Right)		1
O	Pillow		1
P	Leg		4

ASSEMBLY INSTRUCTION

All parts and hardwares.

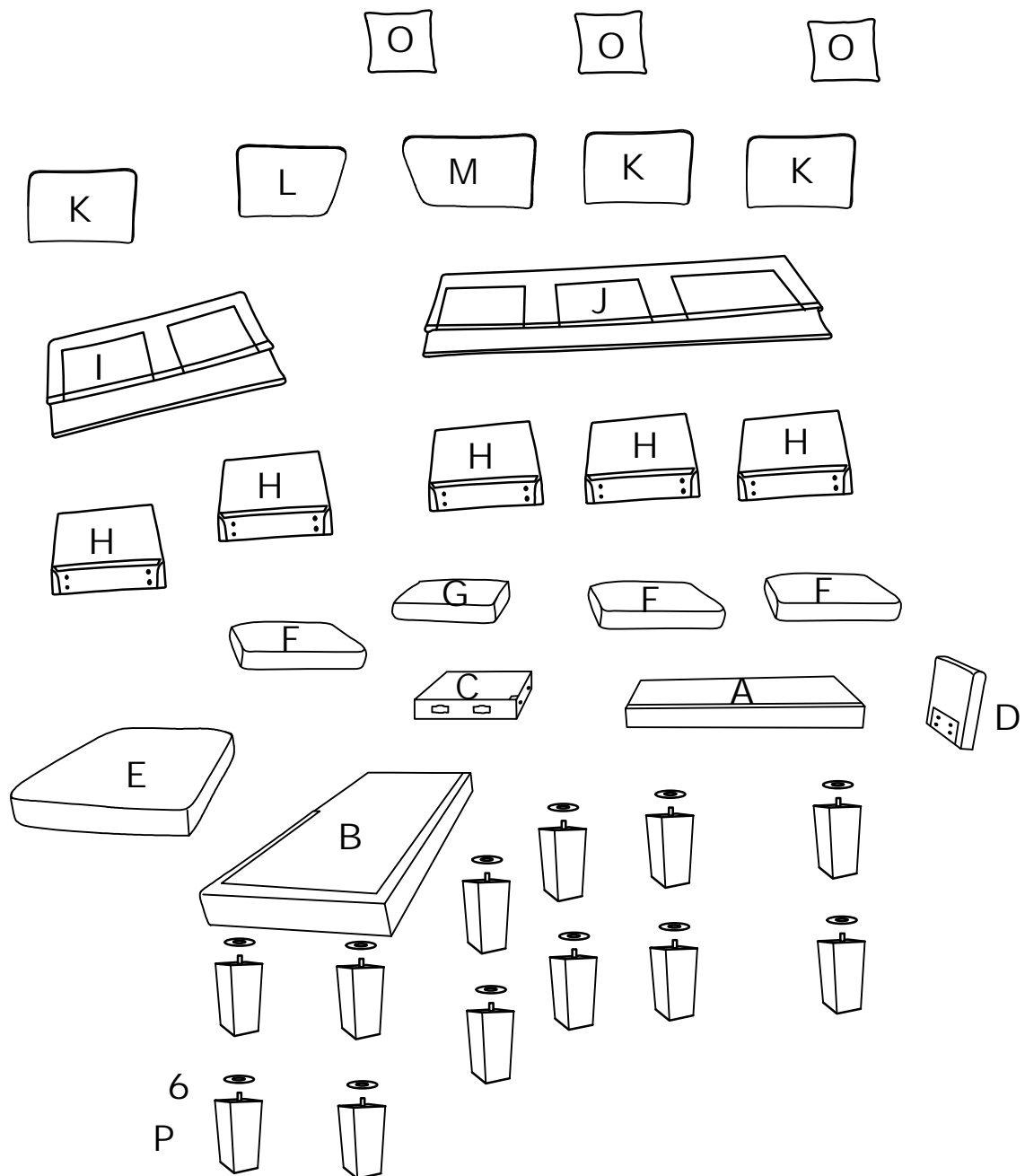

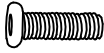

DIAGRAM 1 (Assemble the Armrest)

Install armrest (Part D) on Seat frame (Part A) with 4 washers (Hardware 1) and 4 Screws (Hardware 2).

1		4PCS
2	 M8X60	4PCS

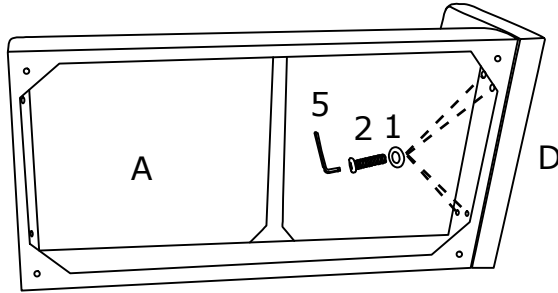

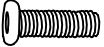



DIAGRAM 2 (Assemble the Seat Frame)

Install Seat frame (Parts A) with the Corner seat frame (Parts C) with Screws M8X80 (Hardware 3) and the Butterfly nut (Hardware 4) and the Washer (Hardware 1) by Wrench (Hardware 5).

1		4PCS
3	 M8X80	2PCS
4		2PCS

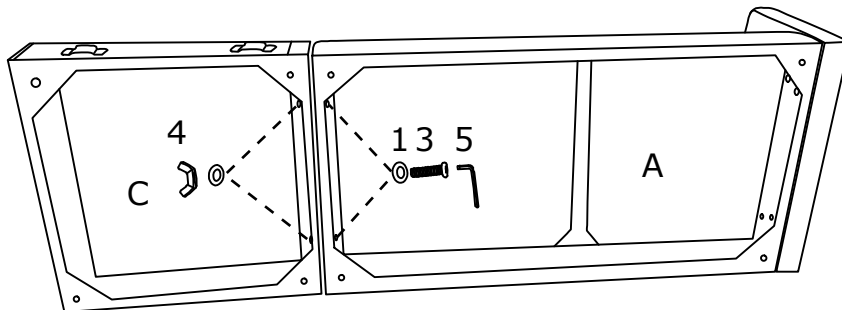



DIAGRAM 3 (Assemble the Legs)

Tighten 1 2 Legs (Parts P) by Plastic gasket(Hardware 6).

6		12PCS
P		12PCS

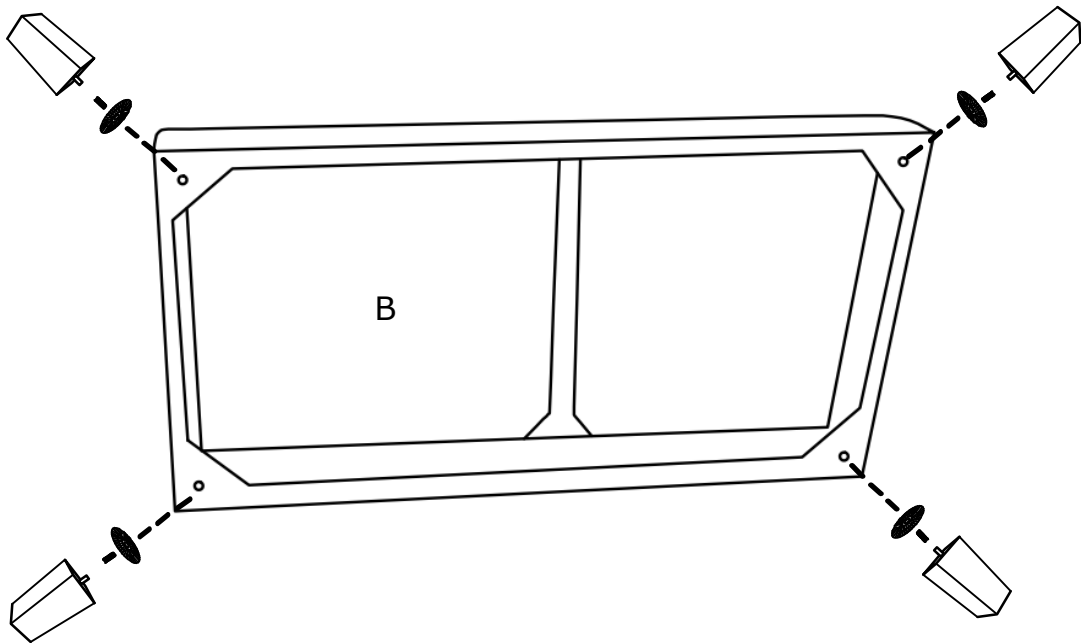
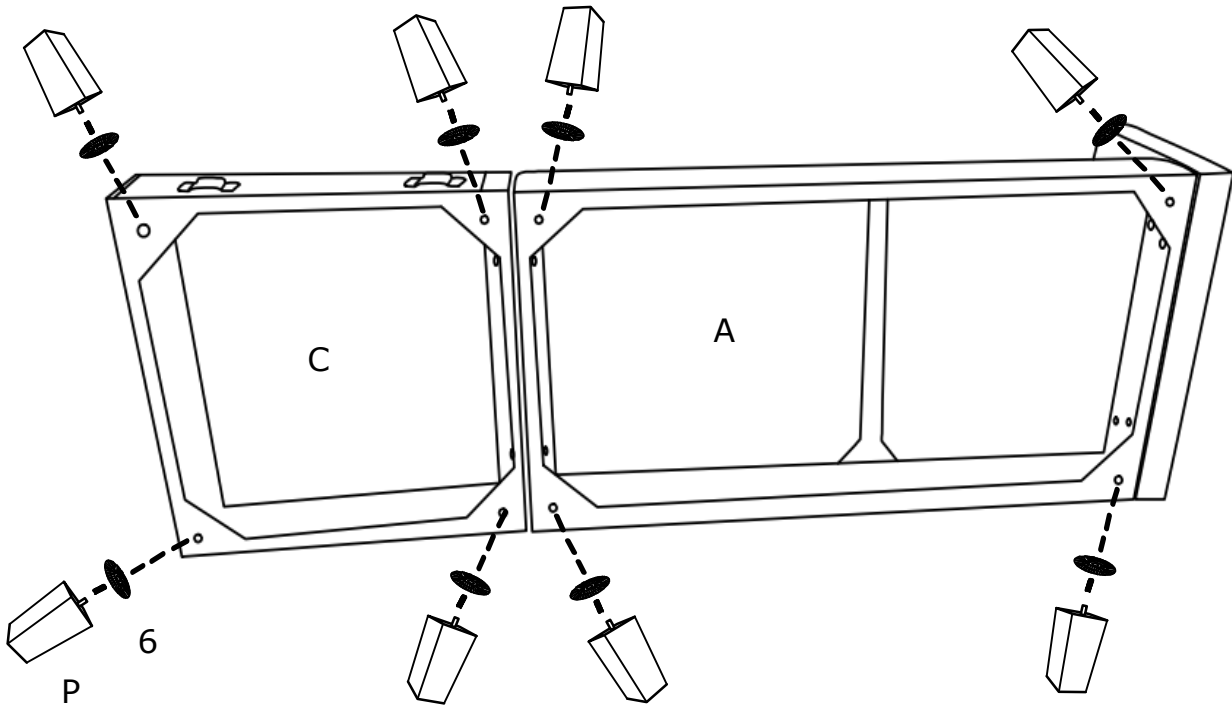



DIAGRAM 4 (Assemble the Back frame)

Connect the Back frame (Parts H) with the Screws M8X60 (Hardware 2) with the Washer (Hardware 1) by Wrench (Hardware 5).

Please install the top screws first, then the bottom screws.

Make sure all the screws are in the holes before tightening all the screws.

Please screw all the screws halfway through and then screw the rest of the way through to make sure the back frame is at the same height.

1		20PCS
2	 M8X60	20PCS

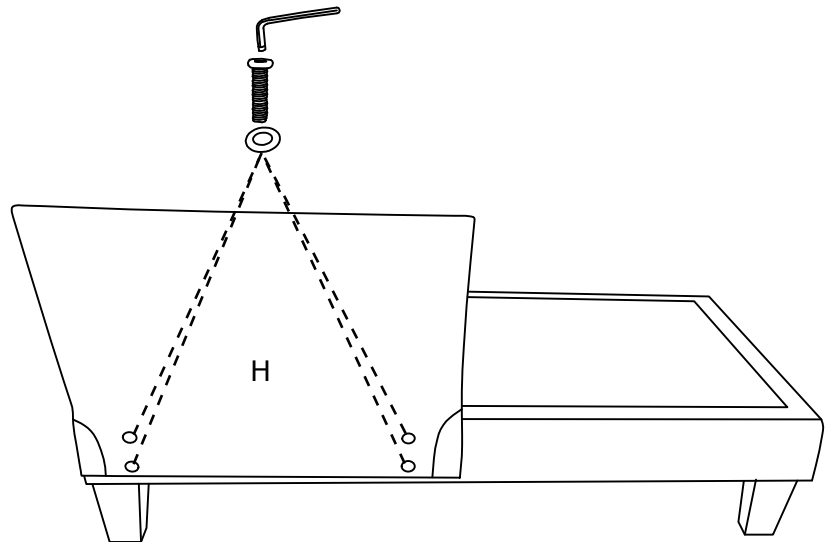
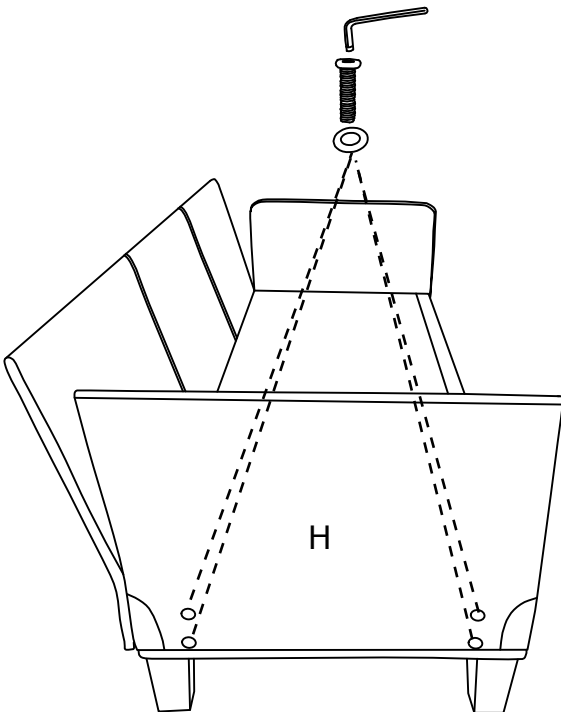
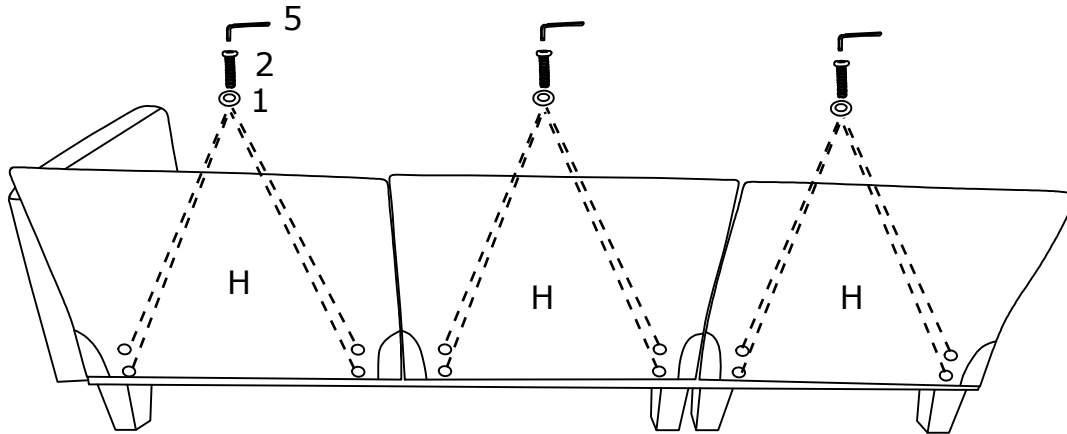

DIAGRAM 5 (Assemble the seat frame)

Attach Chaise Frame(Parts B) to Corner Seat Frame(Parts C) by means of the inserts.

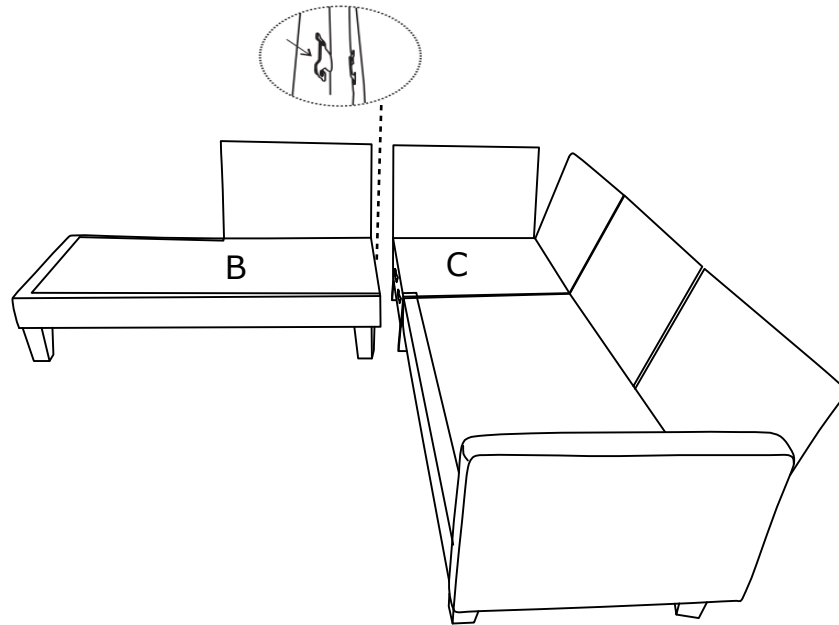

DIAGRAM 6 (Put the Back cover on the Back frame)

Place the Back cover (short) (Parts I) and Back cover (long) (Parts J) on the Back frame.

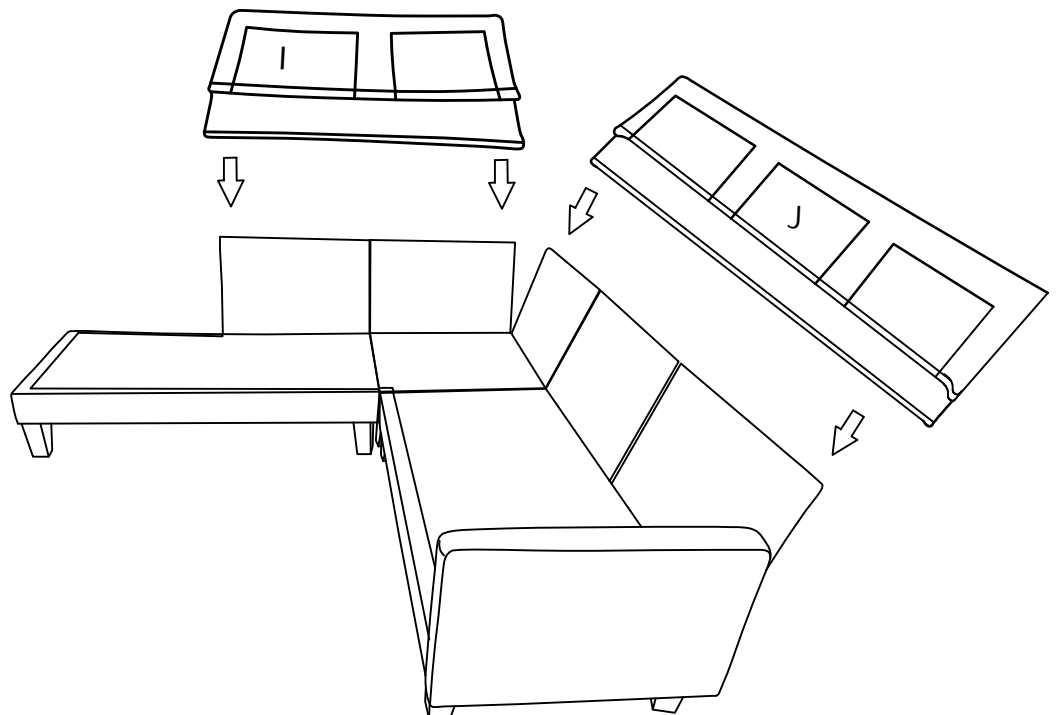
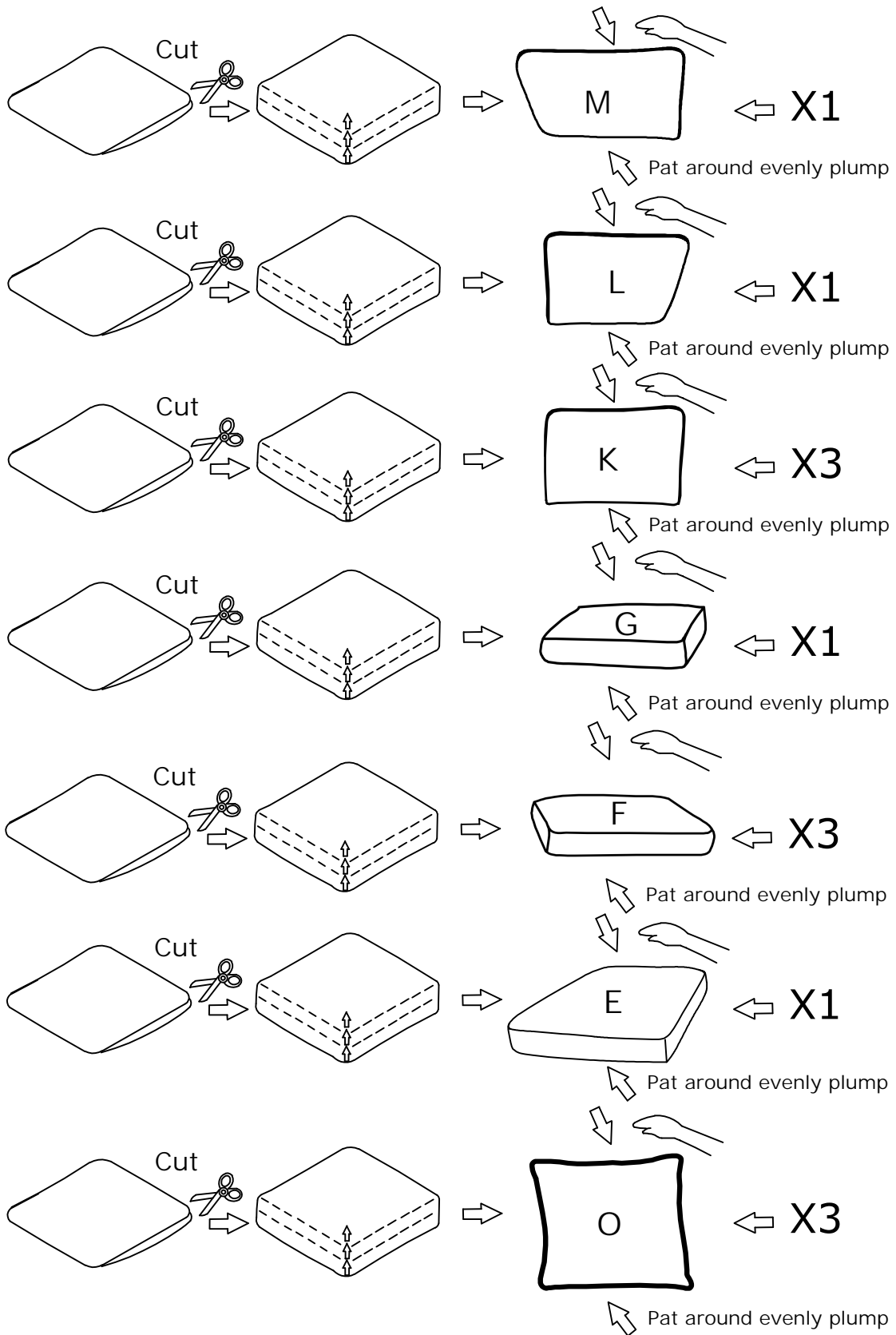

DIAGRAM 7 (Removal of compression bags)

Remove the Seat cushion(Parts H)the Corner seat cushion (Parts I)the Ottoman cushion(Parts F) .



TIPS

1. Please do not open the compressed packages until your sofa frame is completely assembled.
2. Compressed back cushions and pillow need to be fully fulfilled within 72 hours for your perfect use.
3. Please keep children away from plastic bags or any small pieces of stuff.

DIAGRAM 8 (Putting cushions on the sofa)

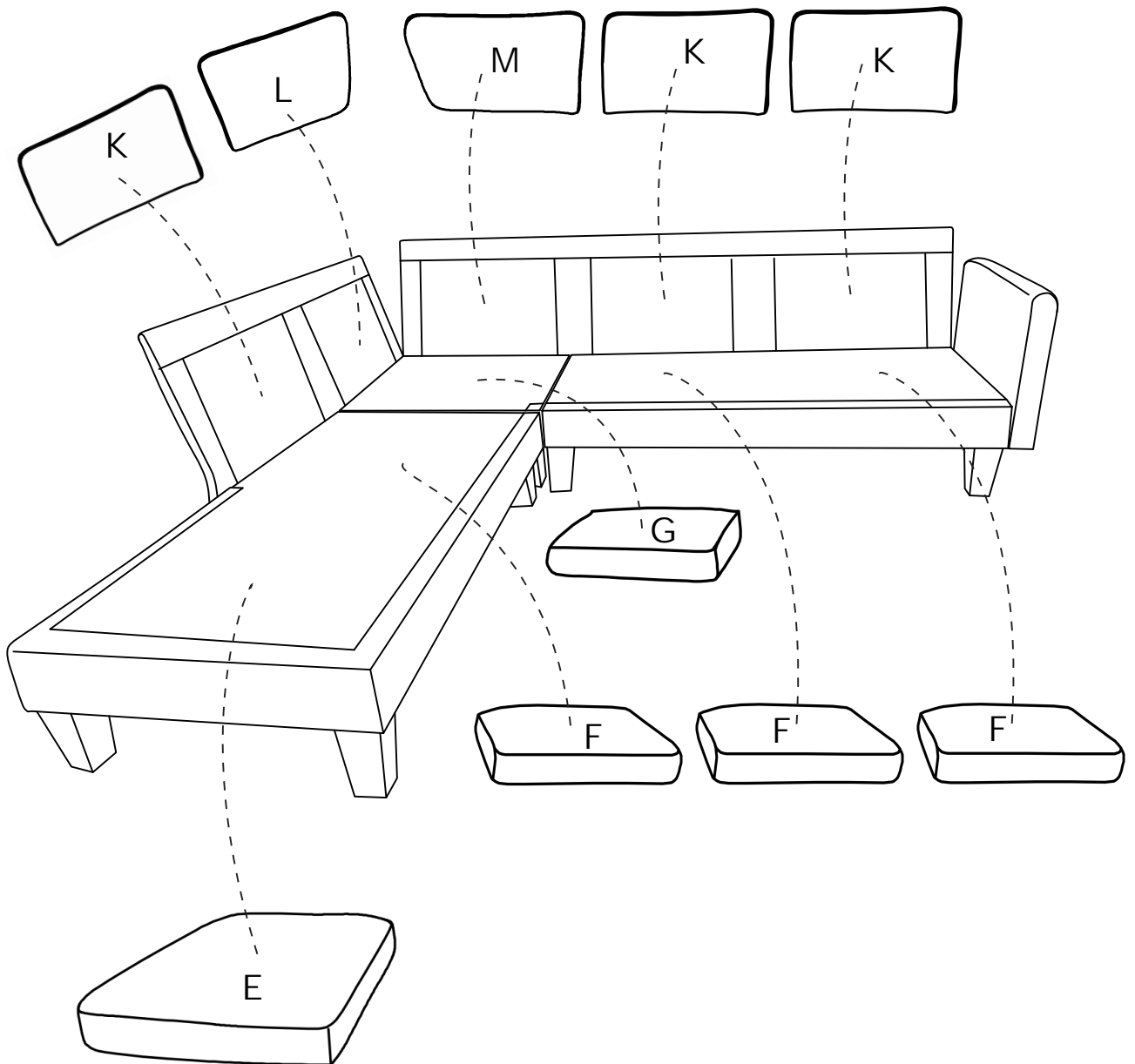
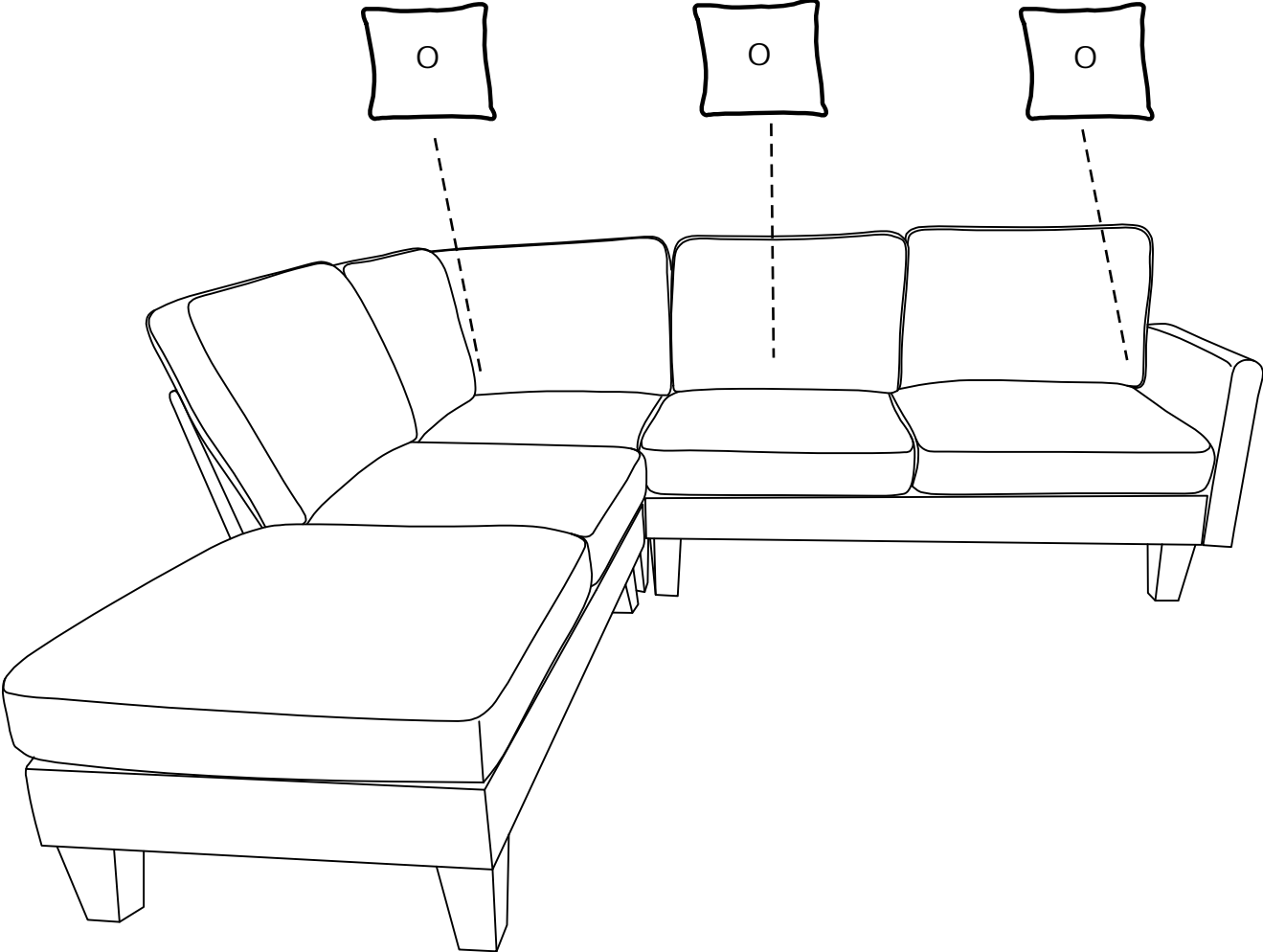

DIAGRAM 9 (Place three Pillows on the sofa)



TIPS

1. Please do not open the compressed packages until your sofa frame is completely assembled.
2. Compressed back cushions and pillow need to be fully fulfilled within 72 hours for your perfect use.
3. Please keep children away from plastic bags or any small pieces of stuff.

