

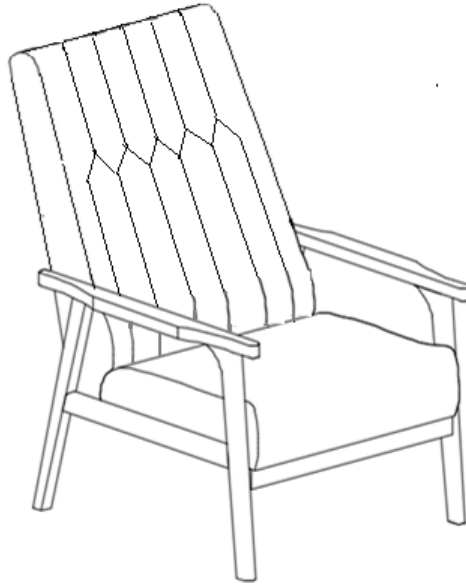





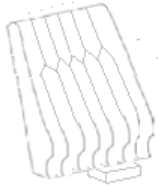

Assembly Instructions

Caution: You must read this before you proceed

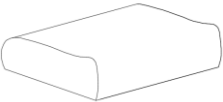
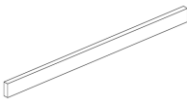
Please look at red string for hardware packs.

Accent Chair



<u>Part List</u>			
Label	Picture	Description	QTY
A		Backrest	1
B		Left Arm Panel	1
C		Right Arm Panel	1
D		Seater	1
E		Seater Rail	1
<u>Hardware</u>			
Label	Picture	Description	QTY
①		Wood Dowel	3
②		Barrel Nut	3
③		Allen Key	1
④		JCBC Bolt (M6 x 50mm)	8
⑤		Washer	2

Assembly Preparation

Before Beginning Assembly:

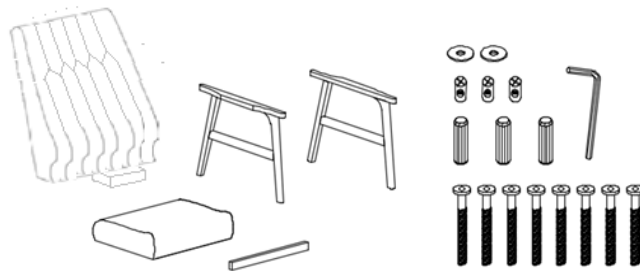

- Read instructions, cover to cover-



- Have 2 adults on hand for assembly-



- Do not assemble on flooring or carpet-



- Assemble on a clean non-marring surface (packing foam)-



- Save all packaging until finished-

Assembly Steps

Overview

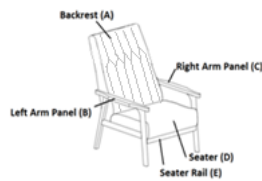

FRONT FACING

This Accent Chair has multiple parts and may require up to 30 minutes to assemble. To give you an overview of the Accent Chair parts, the above picture is to help you put the various parts into perspective. Please read through the instructions below to familiarise yourself with the parts and steps before assembly.

Step 1

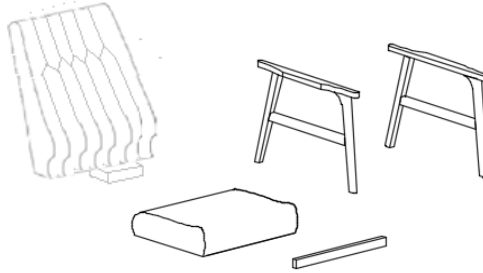

Unpack and place all parts on clean, non-marring surface.

Step 2

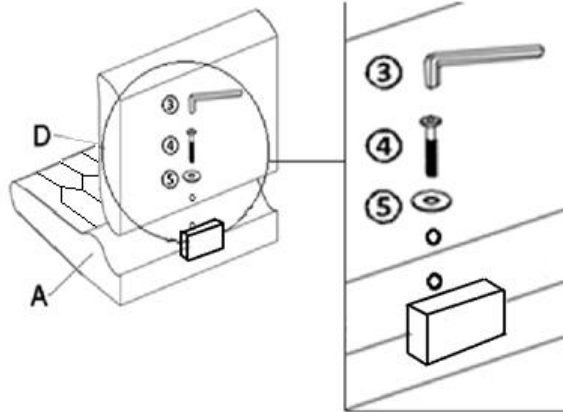

Place the Backrest(A) faceup onto a clean, non-marring surface. Attach Seater(D) to Backrest(A) using JCBC Bolts(4) and Washers(5) with Allen Key(3).
Do not fully tighten the Bolts.

Step 3

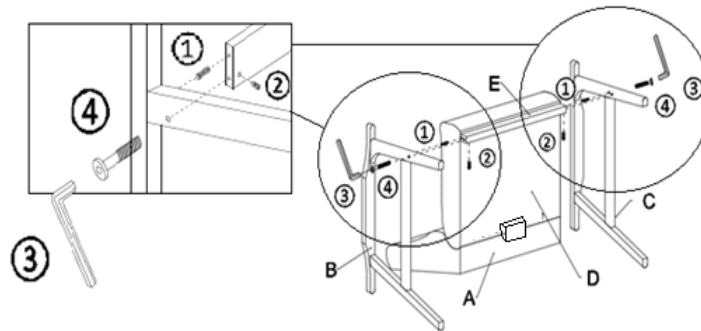

Insert Wood Dowels(1) into the Seater Rail(E) as pictured above. Attach Seater Rail(E) to Right Arm Panel(C) and Left Arm Panel(B) using JCBC Bolts(4) and Barrel Nuts(2) with Allen Key(3).
Do not fully tighten the Bolts.

Step 4

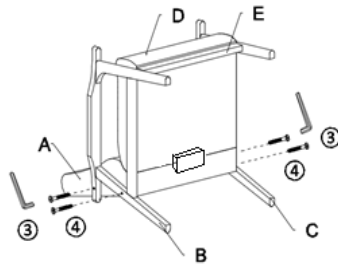

Attach Backrest(A) to Right Arm Panel(C) and Left Arm Panel(B) using JCBC Bolts(4) with Allen Key(3).

Do not fully tighten the Bolts.

Step 5

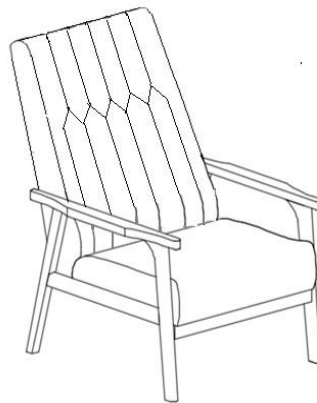

Turn the Accent Chair right side up.

Place the Accent Chair on a LEVEL SURFACE.

Inspect it and make sure all parts are adequately connected.

Gently and gracefully, sit into to the Accent Chair.

This would help to align all the parts at all the joint areas.

Then get off the Accent Chair, and in a sequential manner, proceed to tighten all Bolts.

When tightening these Bolts, tighten sequentially.

DO NOT tighten any Bolt fully and then towards the next one.









This could cause the frame to warp.

If there is still wobbles, loosen the Bolts and execute this same process.

Your Accent Chair is ready to be used.

This Accent Chair can only be used on a flat, level surface.

Care & Maintenance

- ⊘  ● Do not put hot items directly on furniture surface
 - ⊘  ● Do not clean furniture with harsh cleansers or polish.
 - ⊘  ● Do not place furniture under direct sunlight.
 - ⊘  ● Do not place furniture near heating or cooling vents.
 - ⊘  ● Do not write on furniture without a padded barrier to protect the surface.
 - ⊘  ● Do not place furniture outside . For indoor use only .
 - ⊘  ● Not for commercial use. For residential use only .
 - ⊘  ● Stains may be removed with mild soap solution and damp cloth.
 - ⊘  ● Children should not climb or jump on the furniture.
-
- ✓  ● Dust and pick-up spills using a clean, non-colored, lint-free cloth .