

# Assembly Instructions

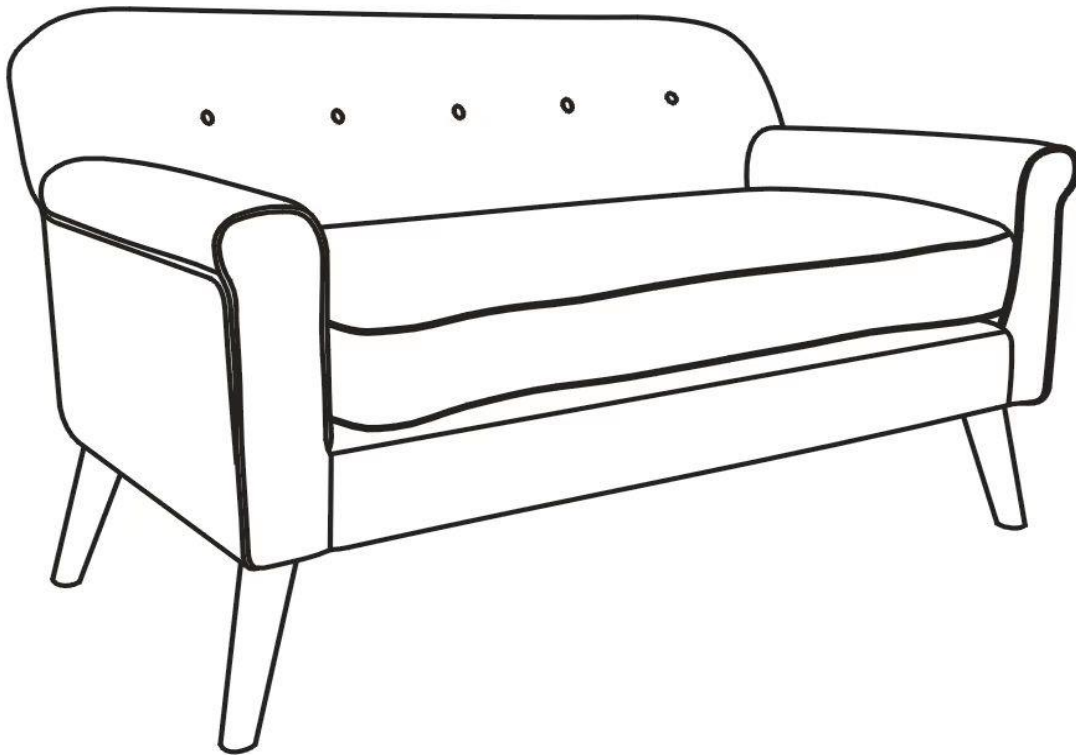

**Caution : You must read this before you proceed**

**Please look in seat for hardware packs and legs.**

## Loveseat

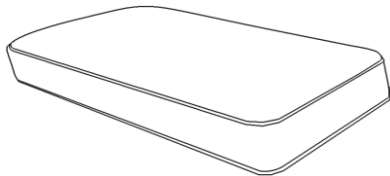

## Parts List

Label	Picture	Description	QTY (pc)
A		Seat cushion	1
B		Wooden Leg	4

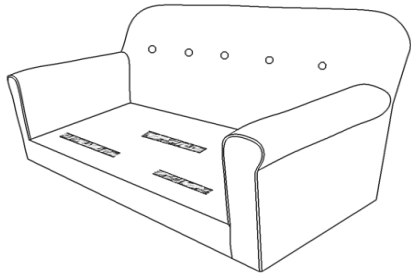
C		Base of Loveseat	1
---	--	------------------	---

## Hardwares List

Label	Picture	Description	QTY (pc)
①		Gasket	3

## Assembly Preparation

Before  
Beginning  
Assembly:

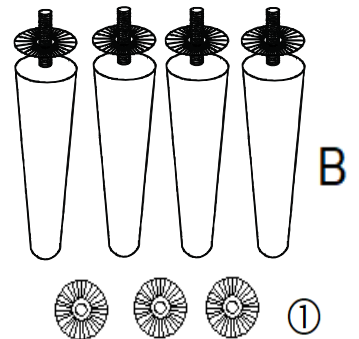
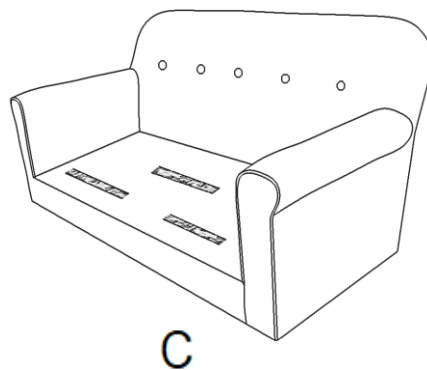
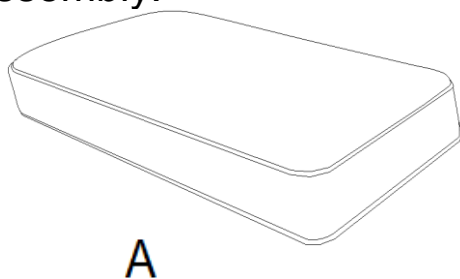

- Read instructions, cover to cover-



- Have 2 adults on hand for assembly-



- Do not assemble on flooring or carpet-



- Assemble on a clean non-marring surface (packing foam)-



- Save all packaging until finished-

# Assembly Steps

## Overview:

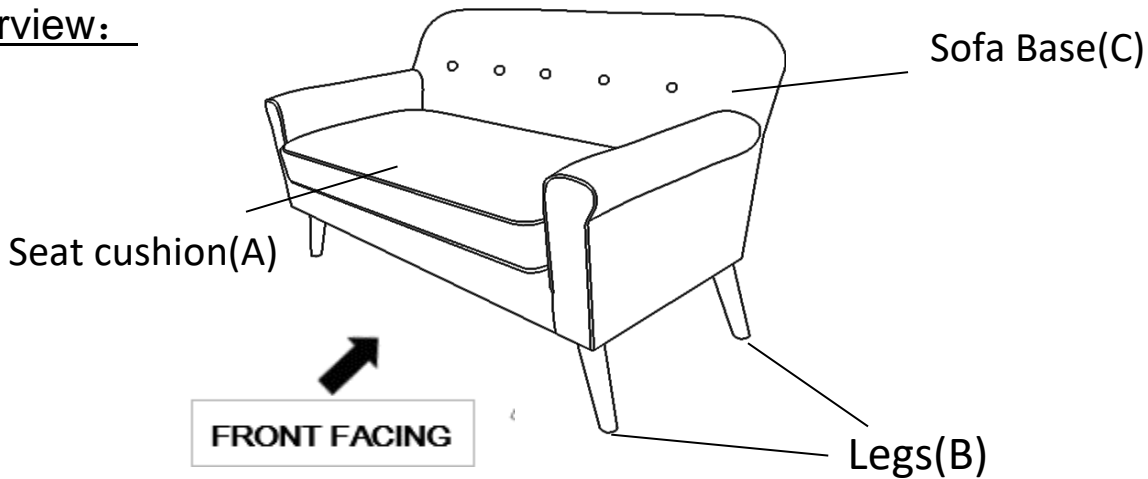

This product has multiple parts and may require up to some 30 minutes to assemble. To give you an overview of the product parts, the above picture is to help you put the various parts into perspective. Please read through the instructions below to familiarise yourself with the parts and steps before assembly.

## Step 1

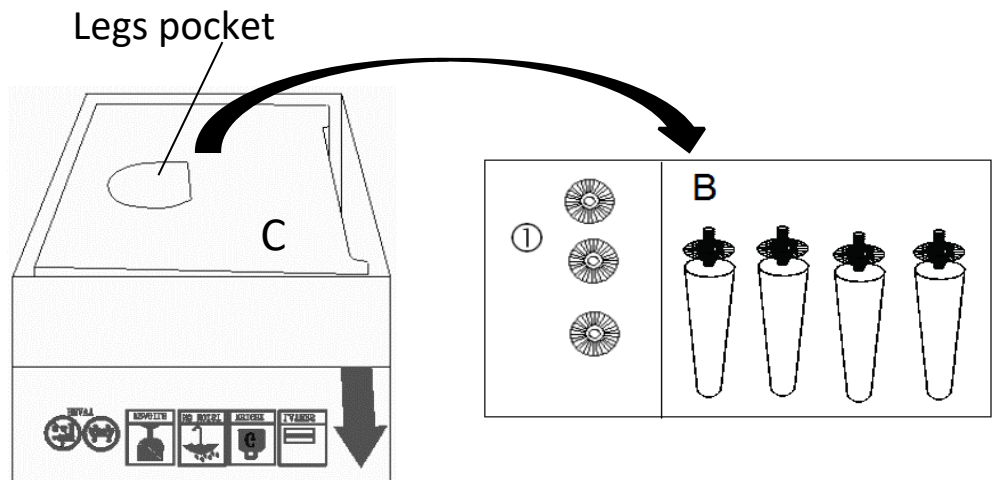

Take out the Legs(B) and Gaskets(1) from the Legs pocket.

## Step 2

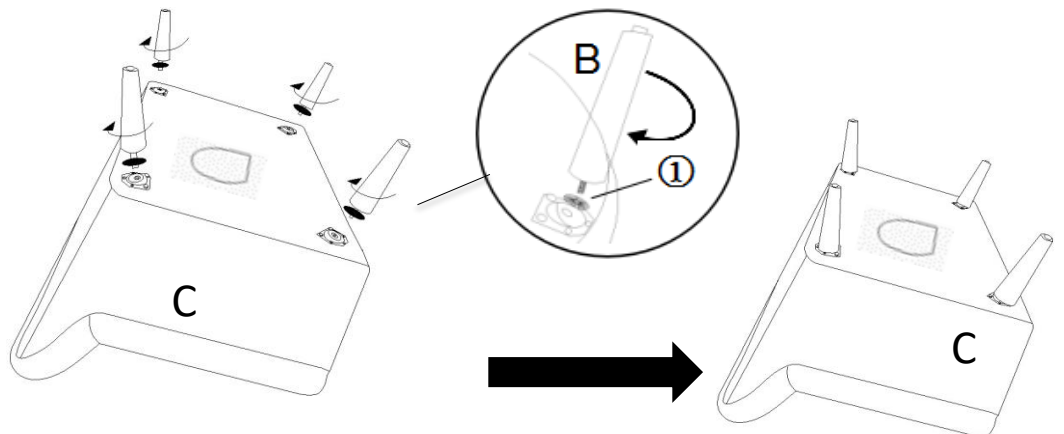

Install the Leg(B)at the bottom of the Sofa by placing one Gasket (①) on the threaded stem.

Then insert threaded stem into the mounting postion at the corner of the Sofa.

**Tighten by turning the Leg clockwise,Do not over tighten.**

Repeat the same process to install the remaining three Legs.

**Note: The use of Gaskets are OPTIONALand are especially useful to help alleviate slight wobbleness. Some Legs may need more than one gasket whilst some Legs may not need any.**

### Step 3

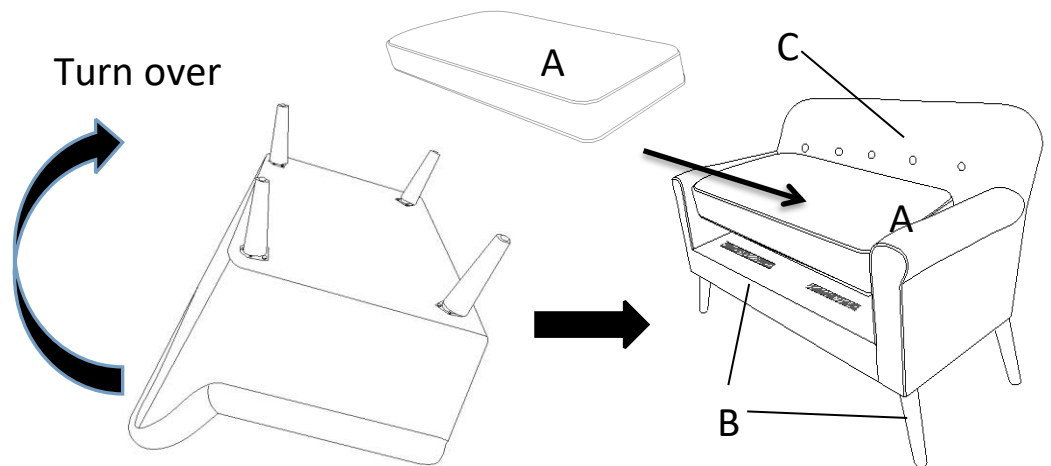

3.1) With help of partner, turn the sofa back to normal position.

3.2) Place the Seat Cushions(A) onto the Sofa.

### Step 4

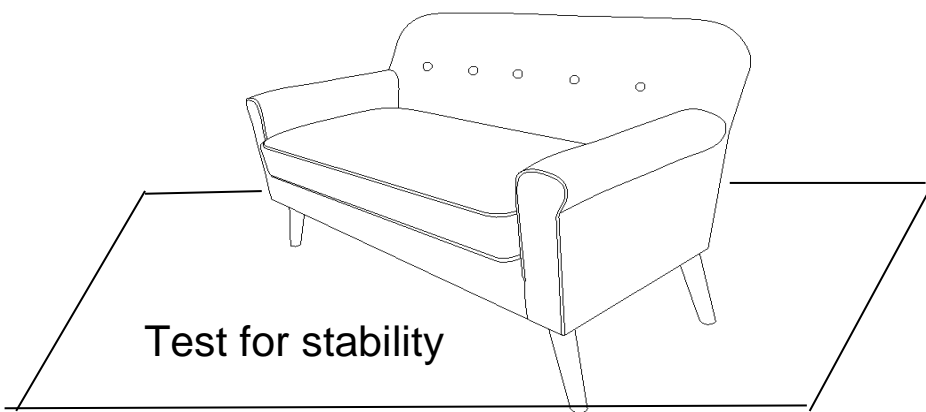











Position Sofa right side up and test for stability.

Your Sofa is ready for use.

**Caution: This Sofa can only be used on a flat, level surface.**

## Care & Maintenance

- ✓  • Furniture may scratch floors. We recommend using furniture pads to protect your floors.
- ⊘  • Do not put hot items directly on furniture surface.
- ⊘  • Do not clean furniture with harsh cleansers or polish.
- ⊘  • Do not place furniture under direct sunlight.
- ⊘  • Do not place furniture near heating or cooling vents.
- ⊘  • Do not write on furniture without a padded barrier to protect the surface.
- ⊘  • Do not place furniture outside . For indoor use only.
- ⊘  • Not for commercial use. For residential use only.
- ⊘  • Stains may be removed with mild soap solution and damp cloth.
- ⊘  • Children should not climb or jump on the furniture.
- ✓  • Dust and pick-up spills using a clean, non-colored, lint-free cloth.