

Assembly Instruction

Sofa

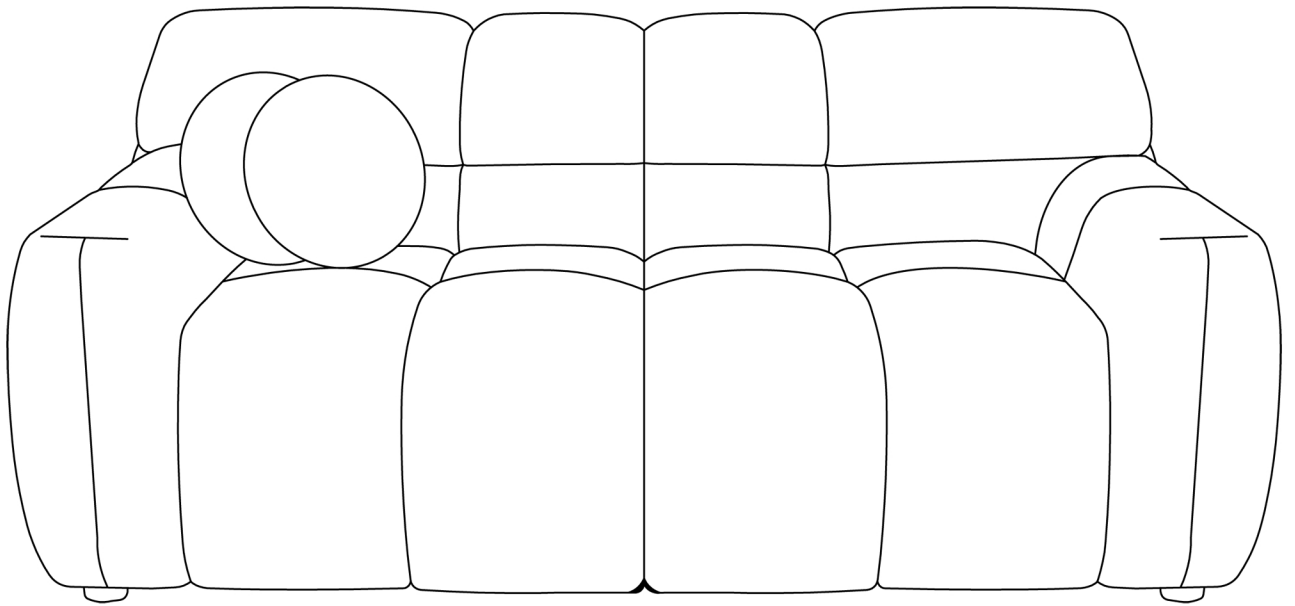
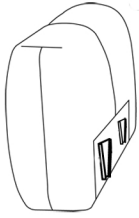
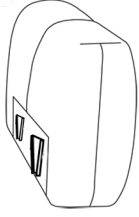
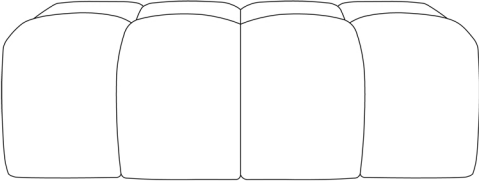
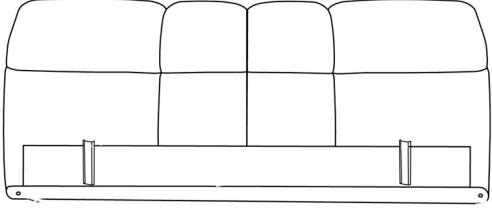
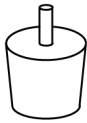
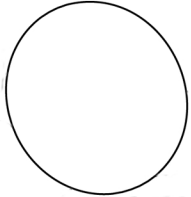

Parts List

Label	Picture	Description	QTY
A		Left Armrest	1
B		Right Armrest	1
C		Seat	1
D		Backrest	1
E		Leg	7
F		Pillow	2

Assembly Preparation

Before Beginning
Assembly:

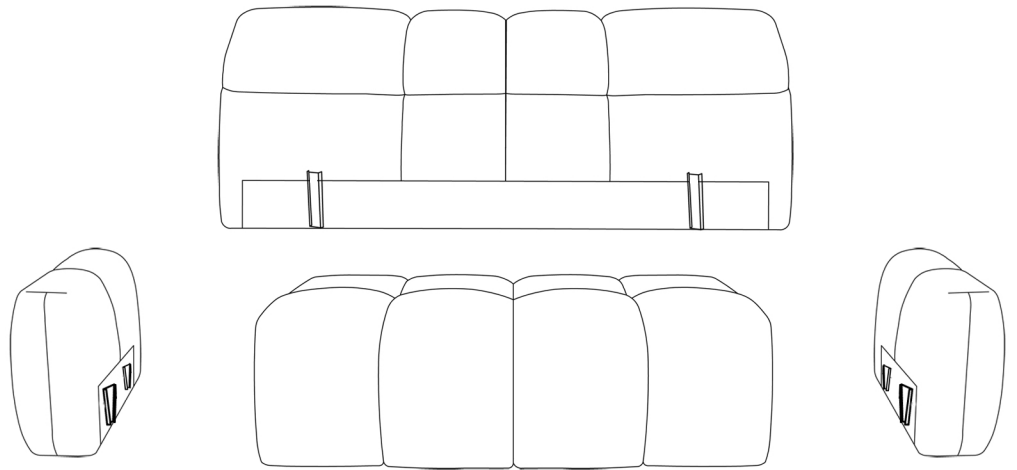

x7

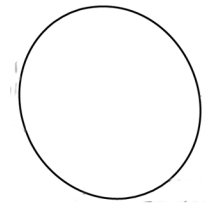

x2



- Read instructions, cover to cover.



- Have 2 adults on hand for assembly.



- Do not assemble on flooring or carpet.



- Assemble on a clean non-marring surface (packing foam).



- Save all packaging until finished.

Step 1

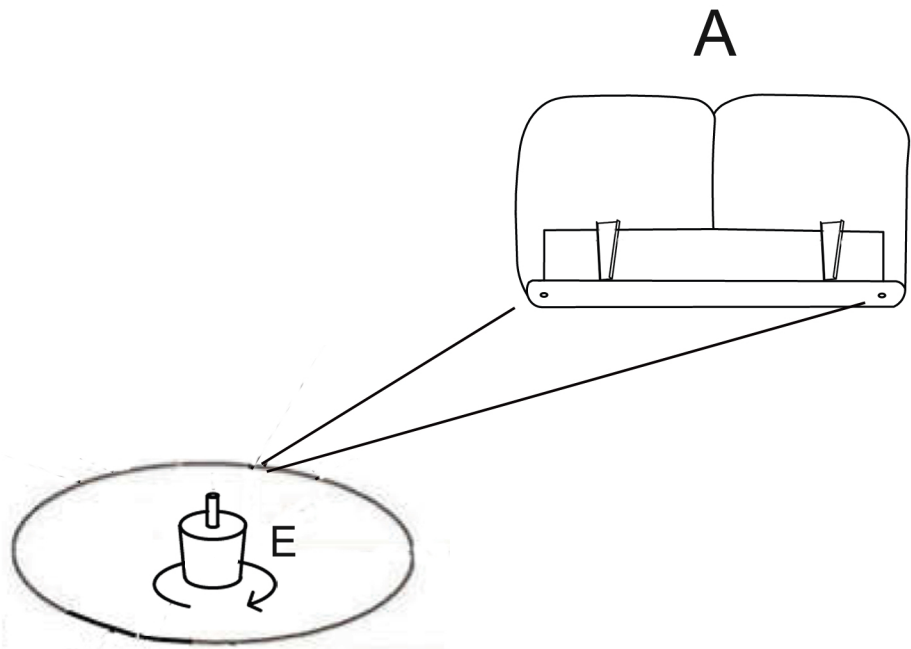
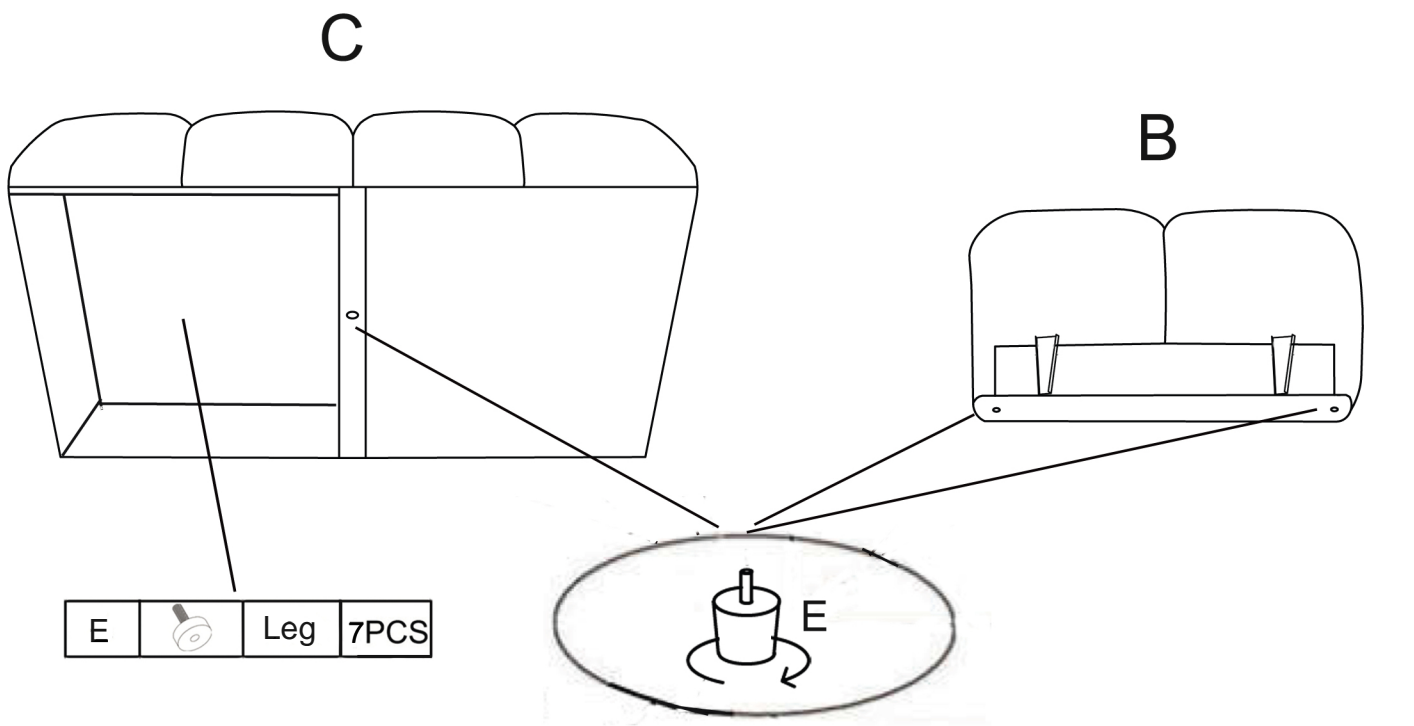

Step2

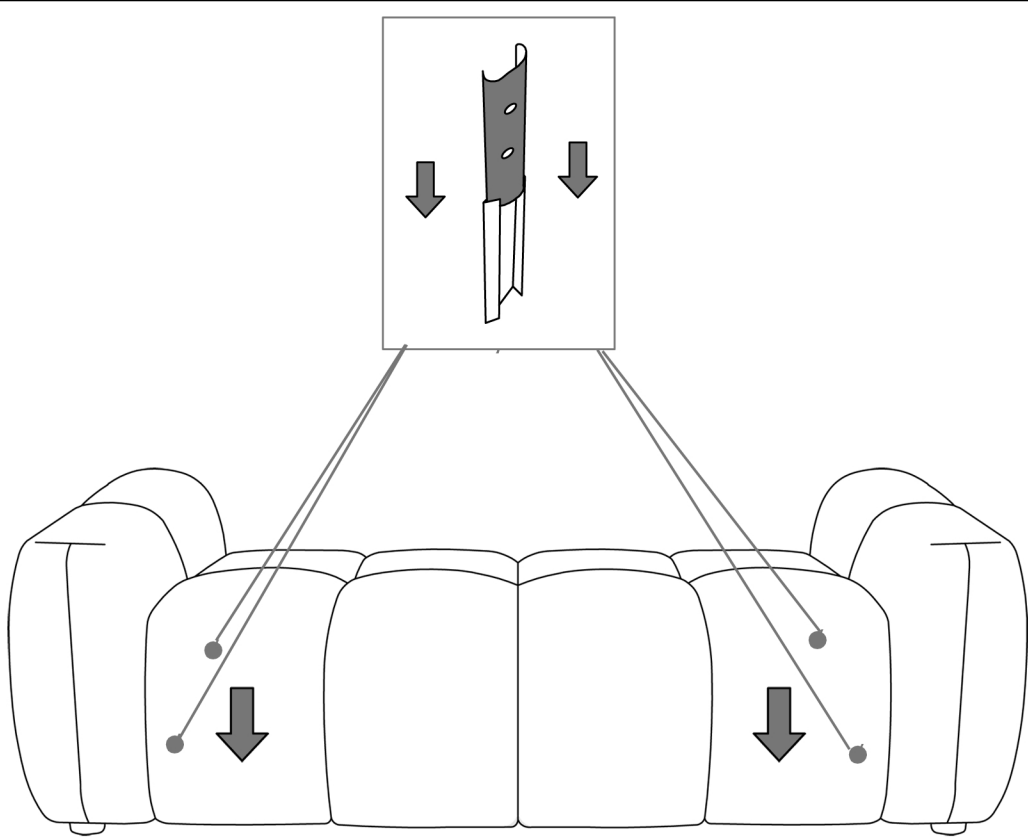

Step3

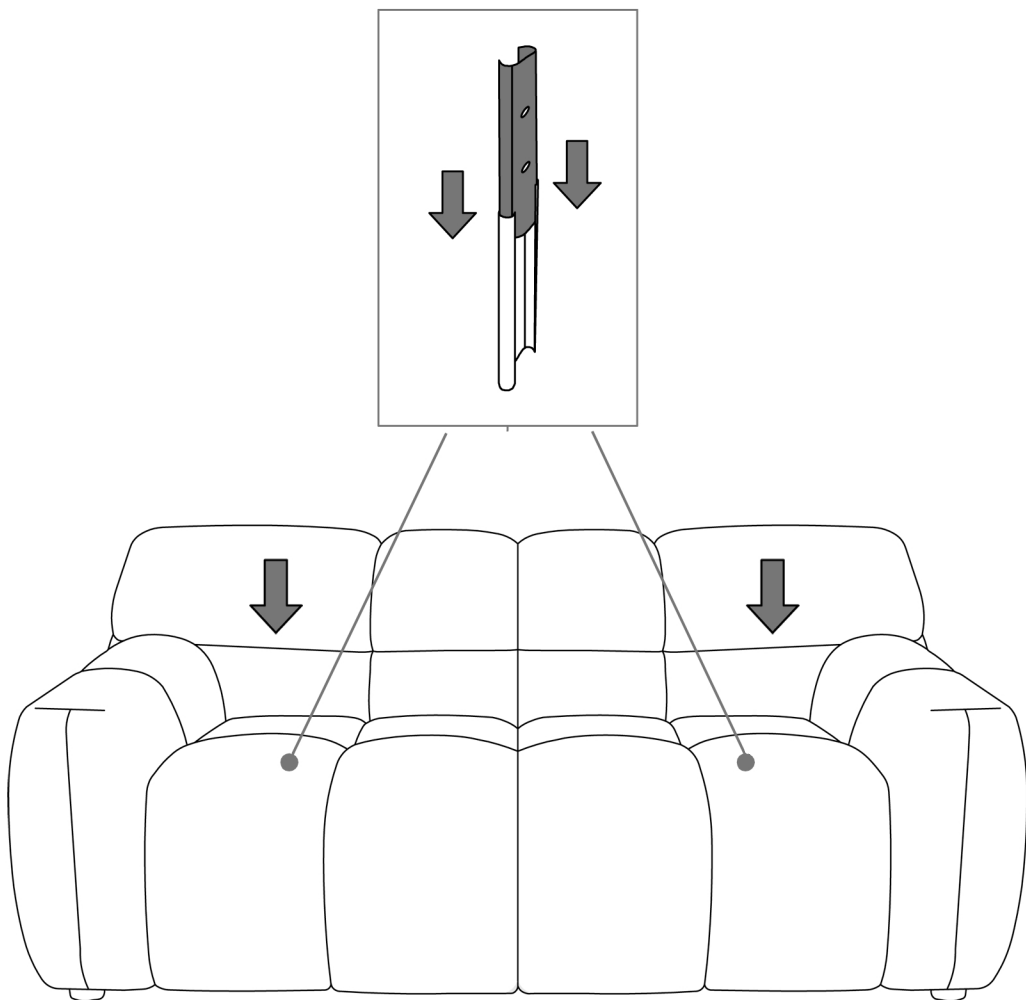

Step4

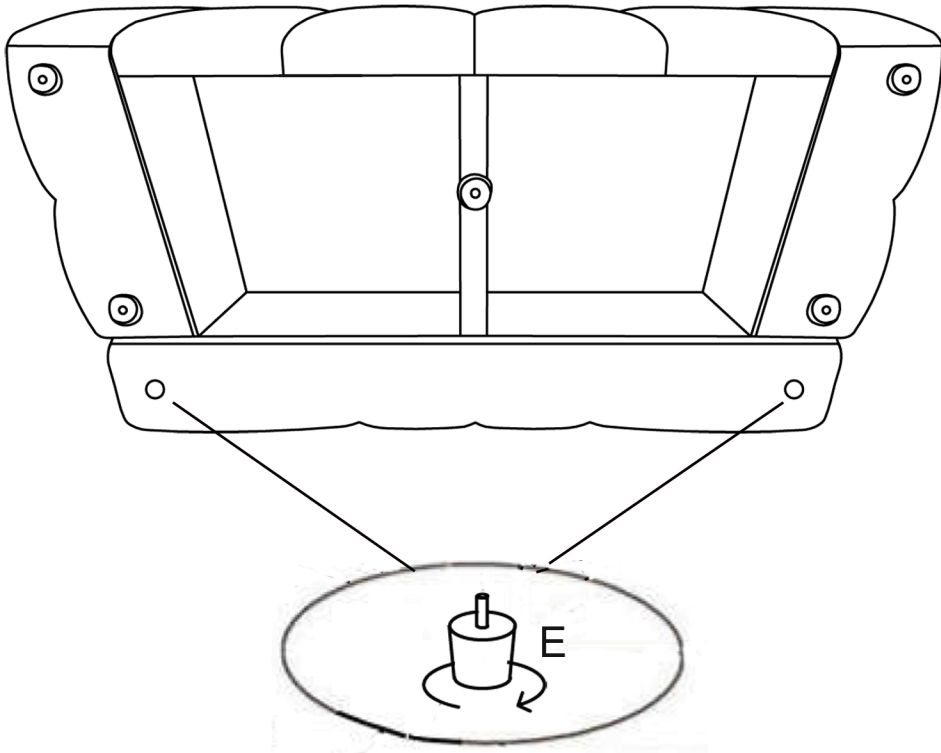

Step5

