

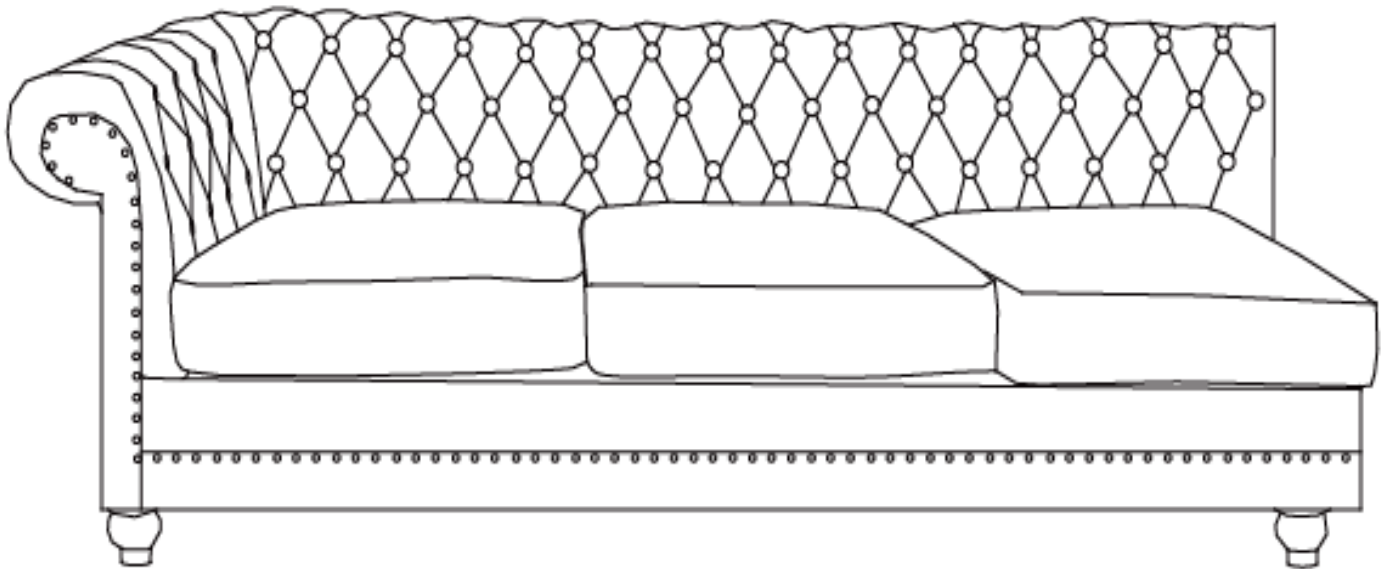



# Assembly Instructions

**Caution: You must read this before you proceed**



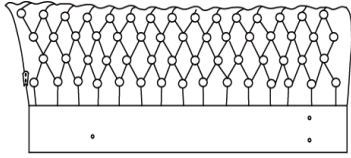
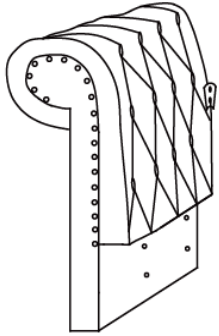
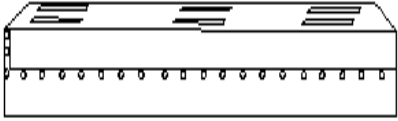

## Left 3 Seater



# Part List

Label	Picture	Description	QTY
A	 A technical drawing of a backrest component. It features a rectangular base with two small dots on the bottom edge. Above the base is a series of vertical lines connected by a series of small circles, forming a mesh-like structure.	Backrest	1
B	 A technical drawing of a left armrest component. It shows a curved, padded armrest with a series of small circles along its top edge. The armrest is attached to a rectangular base with two small dots on the bottom edge.	Left Armrest	1
C	 A technical drawing of a seat component. It shows a rectangular seat with a series of small circles along its bottom edge. There are three small rectangular tabs on the top edge.	Seat	1
D	 A technical drawing of a seat cushion component. It shows a simple, rounded rectangular cushion with a horizontal line across the middle, indicating a seam or fold.	Seat Cushion	3
E	 A technical drawing of a sofa leg component. It shows a small, rounded, bowl-shaped leg with a small rectangular tab on top.	Sofa Leg	4
F	 A technical drawing of a middle support leg component. It shows a simple, cylindrical leg with a small rectangular tab on top.	Middle Support Leg	1

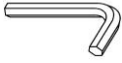
# Hardware

Label	Picture	Description	QTY
①		Bolt (M8*60mm)	8
②		Washer (M8)	8
③		Gasket	9
④		Allen Wrench (M8)	1
⑤		Spring Washer (M8)	8

# Assembly Preparation

Before Beginning Assembly:

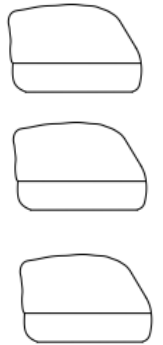
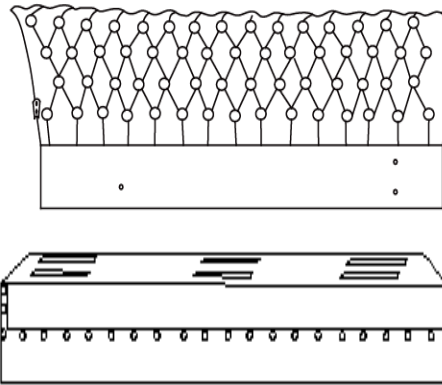
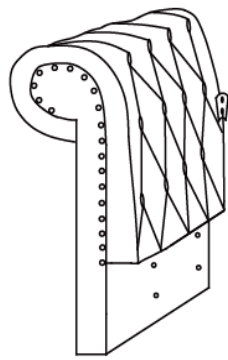

X8



X8



X8



X9



• Read instructions, cover to cover-



• Have 2 adults on hand for assembly-



• Do not assemble on flooring or carpet-



• Assemble on a clean non-marring surface (packing foam)-



• Save all packaging until finished-

# Assembly Steps

## Overview

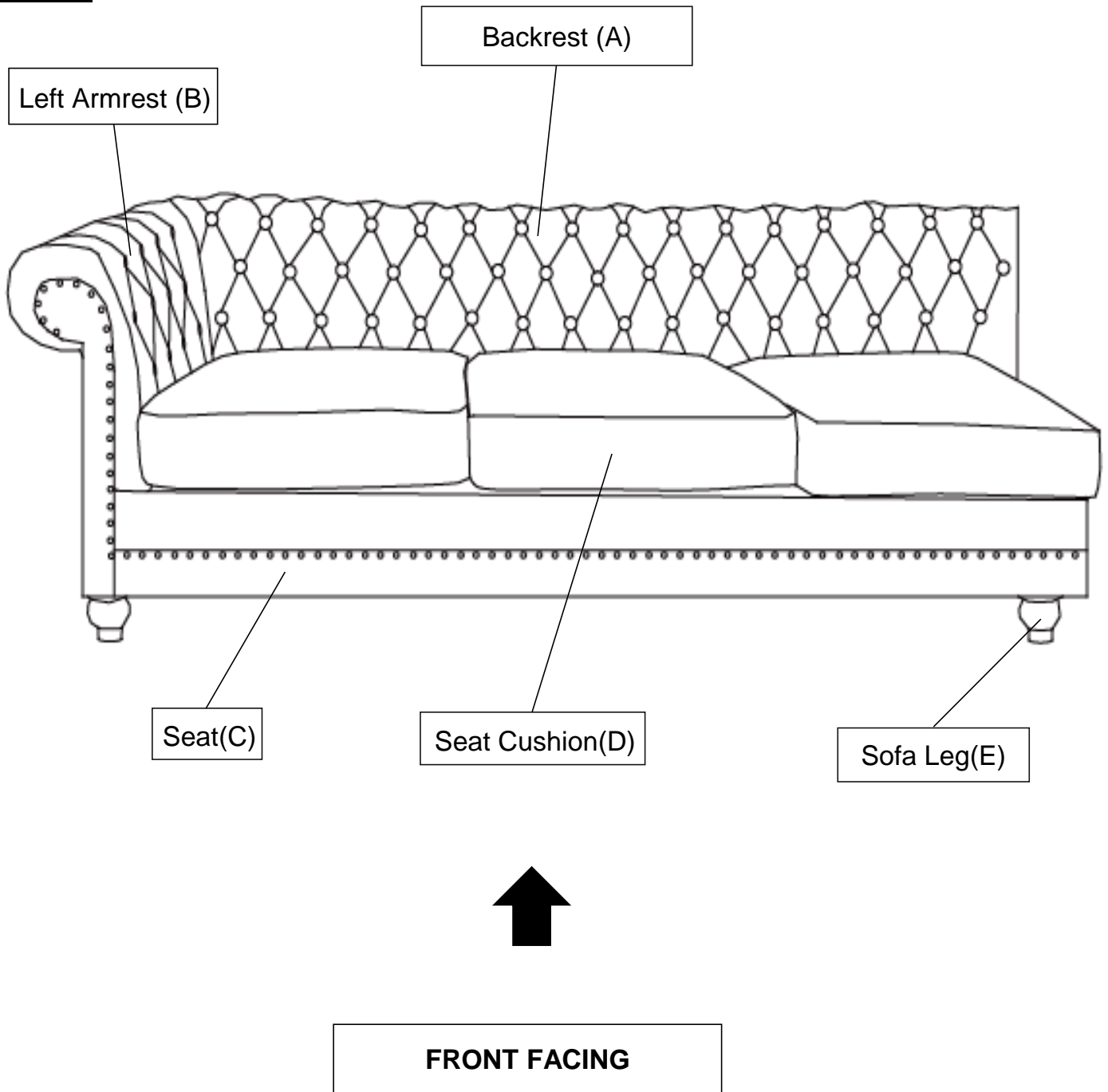

This Sofa has multiple parts and may require up to 60 minutes to assemble. To give you an overview of the Sofa parts, the above picture is to help you put the various parts into perspective. Please read through the instructions below to familiarise yourself with the parts and steps before assembly.

**Note: It is recommended that you have an adult partner to assist during the entire assembly process.**

## Step 1

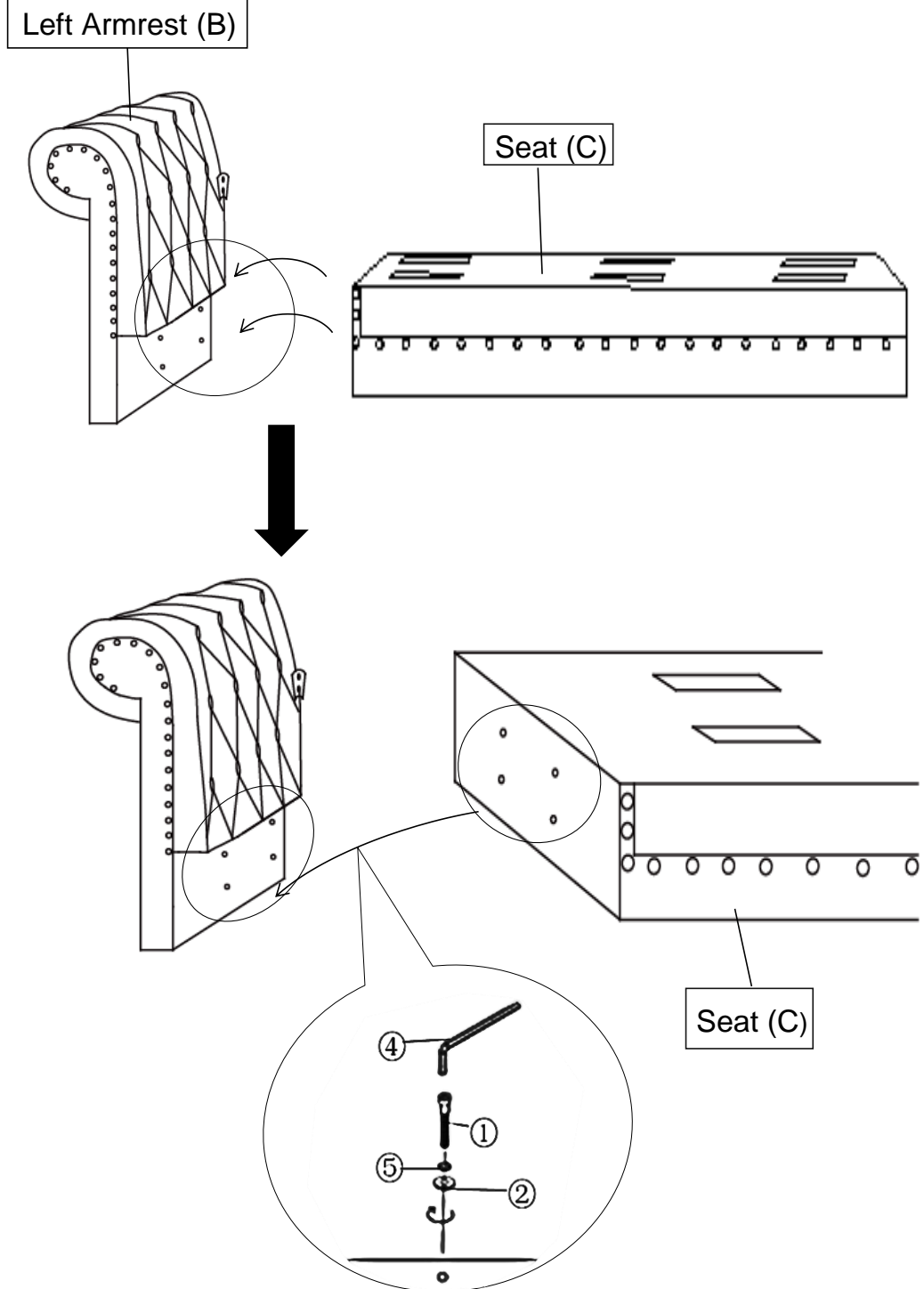

Open the carton and place all the parts on a clean, non-marring surface. With the assistance from your partner, attach the Seat(C) to the Left Armrest(B) using Bolts(①), Spring Washers(⑤), and Washers(②) with the Allen Wrench(④) as pictured above.

**Tighten the Bolts fully in a sequential manner.**

**DO NOT fully tighten a Bolt in one go and then move on to the next.**

**Rather, In a sequential manner, gradually tighten each Bolt little by little until all Bolts are evenly secured.**

**This methodology will ensure maximum evenness once all Bolts are fully tightened.**

**Make sure the bottoms of the Seat(C) and Left Armrest(B) are level.**

**Assistance from an adult partner is needed for this assembly process.**

**Caution: Ensure that your fingers do not get caught or pinched in the assembly process.**

## Step 2

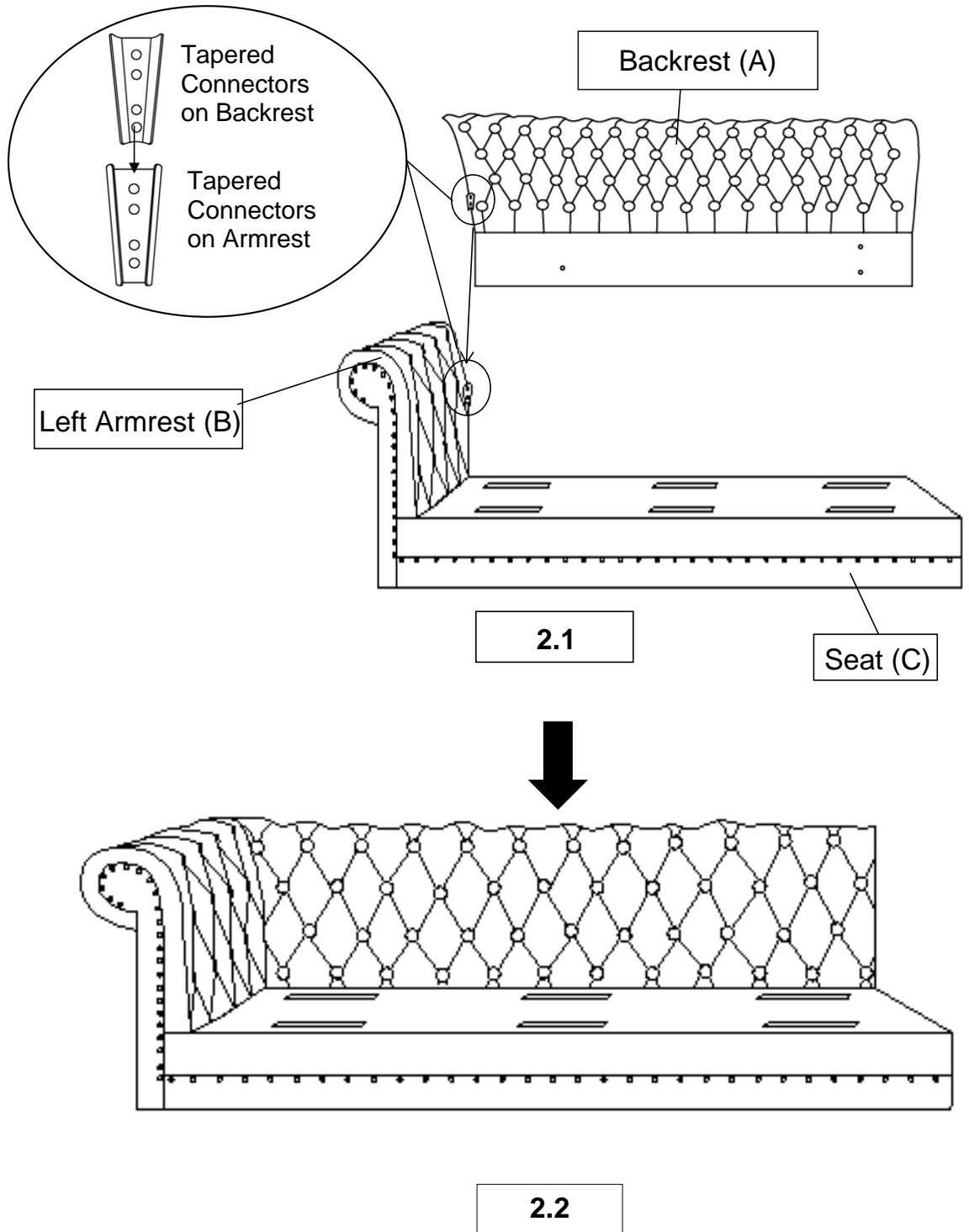

With the assistance from your adult partner:

**2.1)** Lift the Backrest(A) up, make sure the Backrest(A) is vertical and aligned to the Seat and Armrest. Align the Tapered Connectors on the Backrest(A) with those on the Left Armrest(B). Your adult partner may need to push the Armrest inwards towards the Backrest(A) to allow for better alignment. Slip and Slide the Backrest in a gradual and balanced manner into the Tapered Connectors.

**2.2)** Push the Backrest(A) downwards until it is fully slotted and locked into position.

**Note: Make sure the Tapered Connectors on the Backrest(A) lock into the Tapered Connectors on Left Armrest(B) .**

**Fully locked position: Check and assess that the base of the Backrest(A) and Seat(C) are aligned and level.**

### Step 3

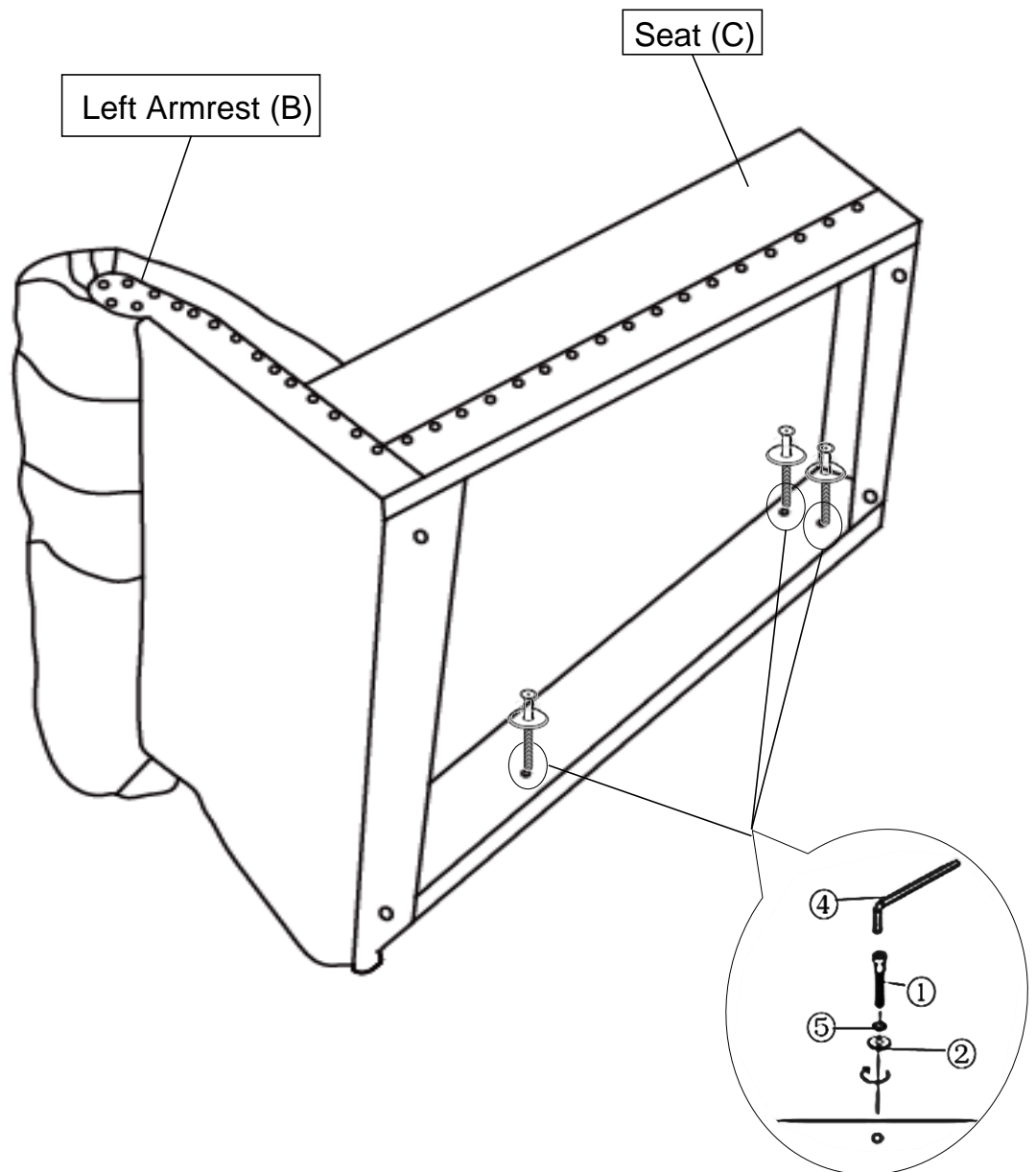

Tilt and lay the Sofa on its Backrest(A) onto a flat surface.

Attach the Seat(C) to the Backrest(A) using Bolts(①), Spring Washers(⑤), and Washers(②) with the Allen Wrench(④) as pictured above.

**Tighten the Bolts fully in a sequential manner.**

**DO NOT fully tighten a Bolt in one go and then move on to the next.**

**Rather, In a sequential manner, gradually tighten each Bolt until all Bolts are evenly secured.**

**This methodology will ensure maximum evenness once all Bolts are fully tightened.**

**Note: If you can not insert the Bolts into position, please back to Step 2 to "push Backrest downwards".**

## Step 4

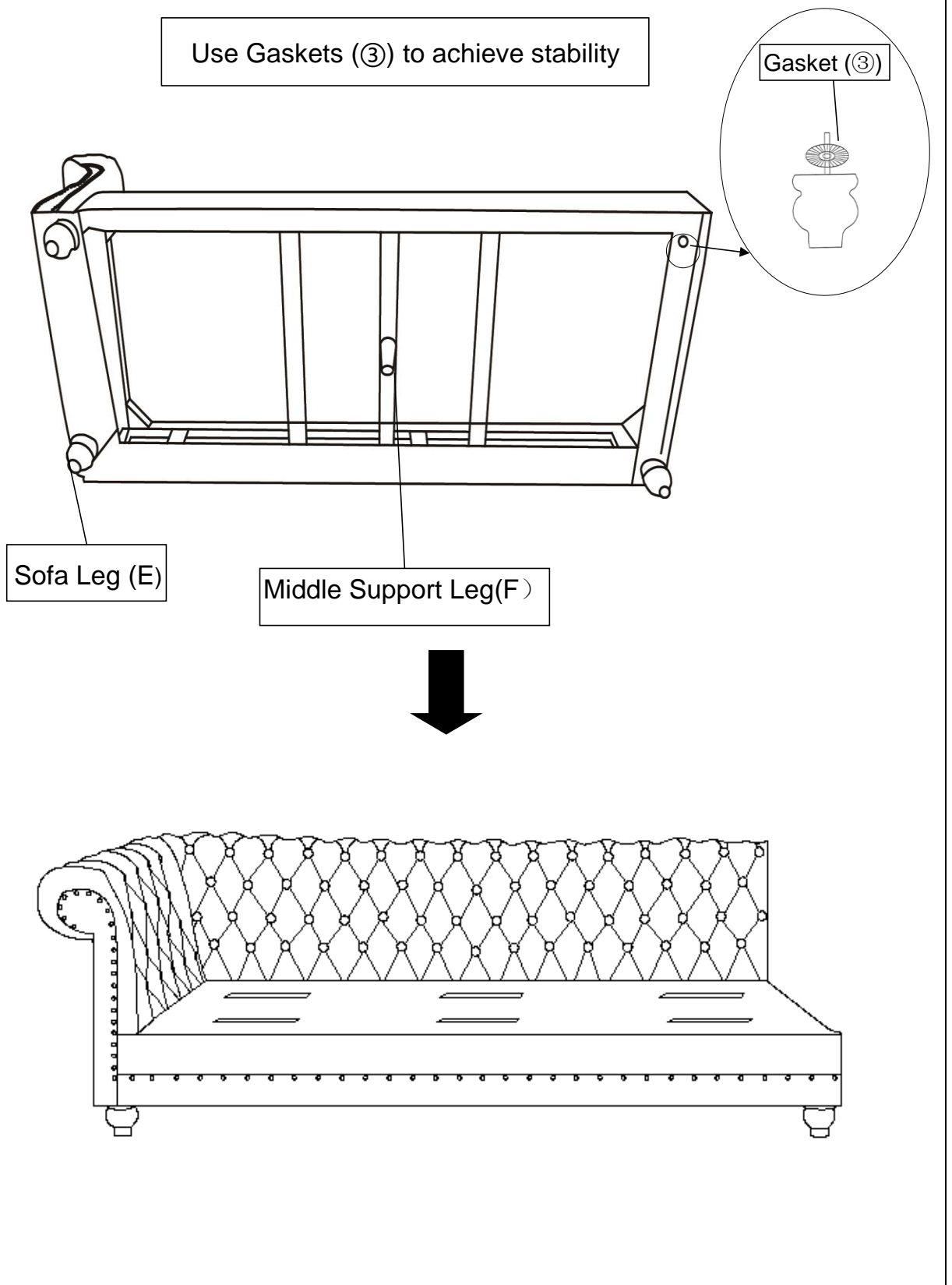

Install the Sofa Legs(E) and Middle Support Leg(F) at the bottom of the Sofa by placing one Gasket(③) on the threaded stem.  
Then insert the threaded stem into the threaded mounting position at the corners of the Sofa.  
Tighten by turning the Leg clockwise.  
**Note: The use of Gaskets are OPTIONAL and are especially useful to help alleviate slight wobbles. Some Legs may need more than one whilst some Legs may not need any.**



Step 5

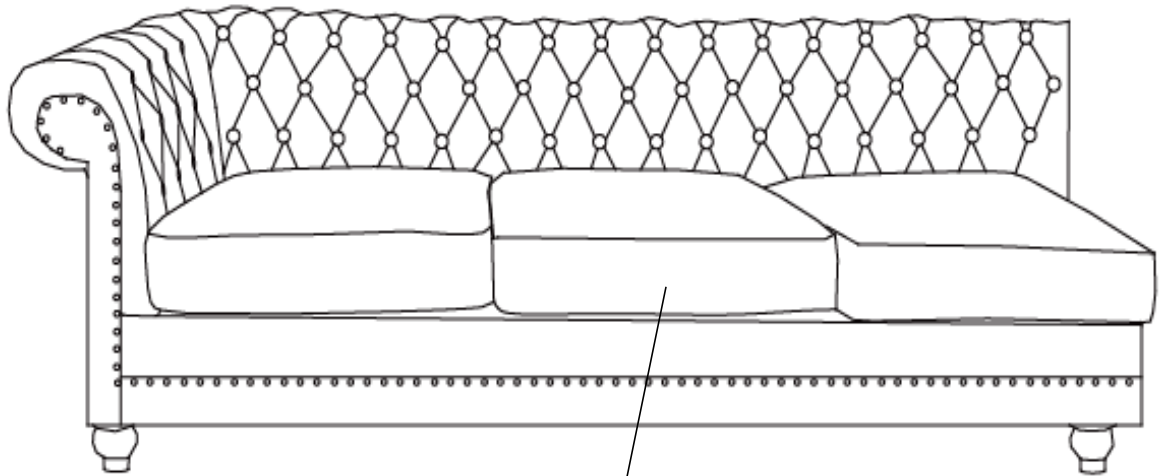

Seat Cushion (D)

Place the Seat Cushions(D) onto the Sofa.  
Your Sofa is ready for use.  
**This Sofa can only be used on a flat, level surface.**

## Additional Steps

### Step 1

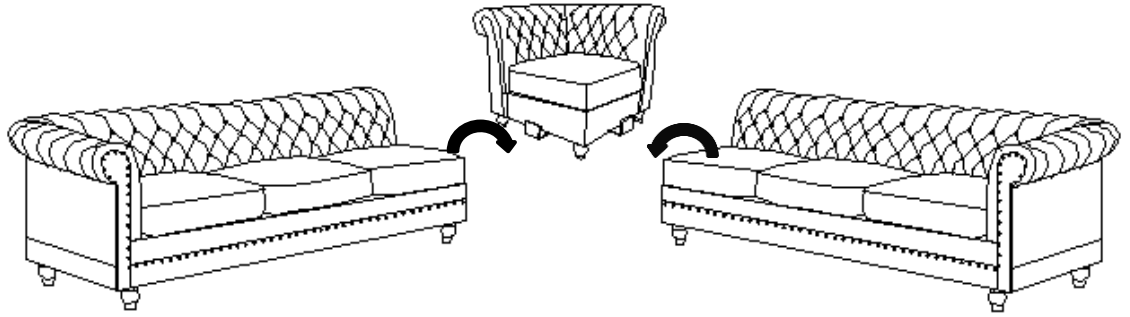

Connect the Sofas by intersecting the metal brackets.  
Make sure all parts are connected and securely locked into position.

### Step 2

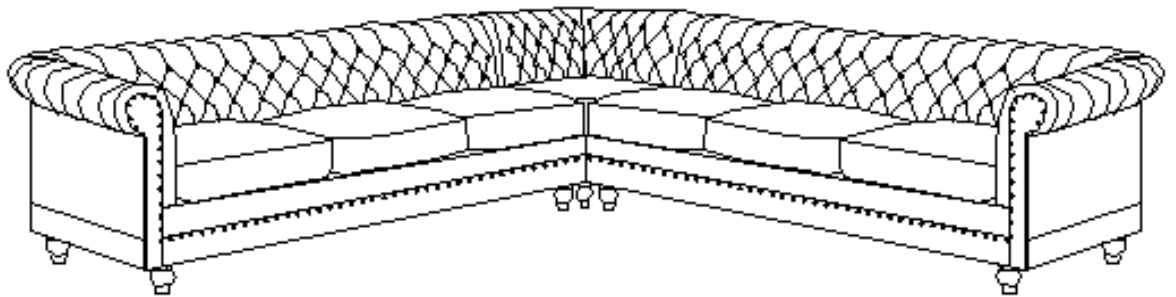

Your Sofa Set is ready for use.  
**This Sofa Set can only be used on a flat level surface.**

## Care & Maintenance



- Furniture may scratch floors. We recommend using furniture pads to protect your floors.



- Do not put hot items directly on furniture surface.



- Do not clean furniture with harsh cleansers or polish.



- Do not place furniture under direct sunlight.



- Do not place furniture near heating or cooling vents.



- Do not write on furniture without a padded barrier to protect the surface.



- Do not place furniture outside . For indoor use only.



- Not for commercial use. For residential use only.



- Stains may be removed with mild soap solution and damp cloth.



- Children should not climb or jump on the furniture.



- Dust and pick-up spills using a clean, non-colored, lint-free cloth.