

ASSEMBLY INSTRUCTION

WF304970(X2) WF304972

Friendly Reminder:

- 1.This sofa is packed in 3 boxes. Please assemble it After all boxes are received.
- 2.As the cushions are all vacuum compressed,there will be some wrinkles. Please give your cushions up to 72 hours to reach its original size and the wrinkles will basically disappear.
- 3.Please do not open the compressed packags until your sofa frame is completely assembled.

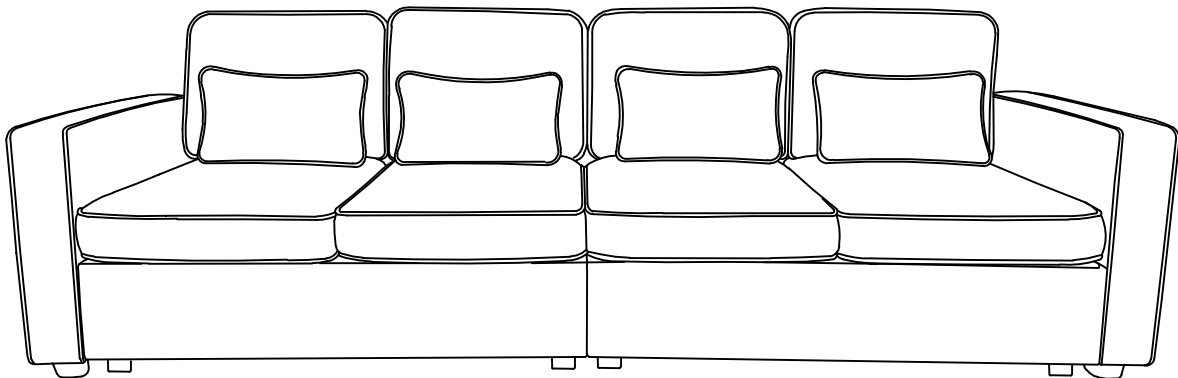









Return & Warranty policy:







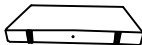

- We strive to offer the highest quality products,and we also try our best to satisfy each and every customer that orders from us with replacement parts or service as needed.
- If the item is damaged or defective, please take photos as evidence for replacements and refunds.
- Please do not return to store,contact the seller if you have any troubles with this product.

ASSEMBLY INSTRUCTION

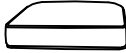

HARDWARE

NO	DESCRIPTION	SKETCH	QTY
1	Washer		30
2	Screws 6X35		2
3	Screws 8X40		8
4	Screws 8X60		16
5	Screws 8X80		2
6	Butterfly nut		2
7	Wrench		1
8	Plastic gasket		12

PARTS LIST WF304970(X2)

NO	DESCRIPTION	SKETCH	QTY
A	Seat frame		1
D	Front baffle		1
E	Back frame		2
F	Back cover		1
G	Seat cushion		2
H	Back cushion(big)		2
I	Back cushion(small)		2
J	Leg(big)		4
K	Leg(small)		2

ASSEMBLY INSTRUCTION

PARTS LIST WF304972			
NO	DESCRIPTION	SKETCH	QTY
B	Armrest (left)		1
C	Armrest (right)		1

All parts and hardwares.

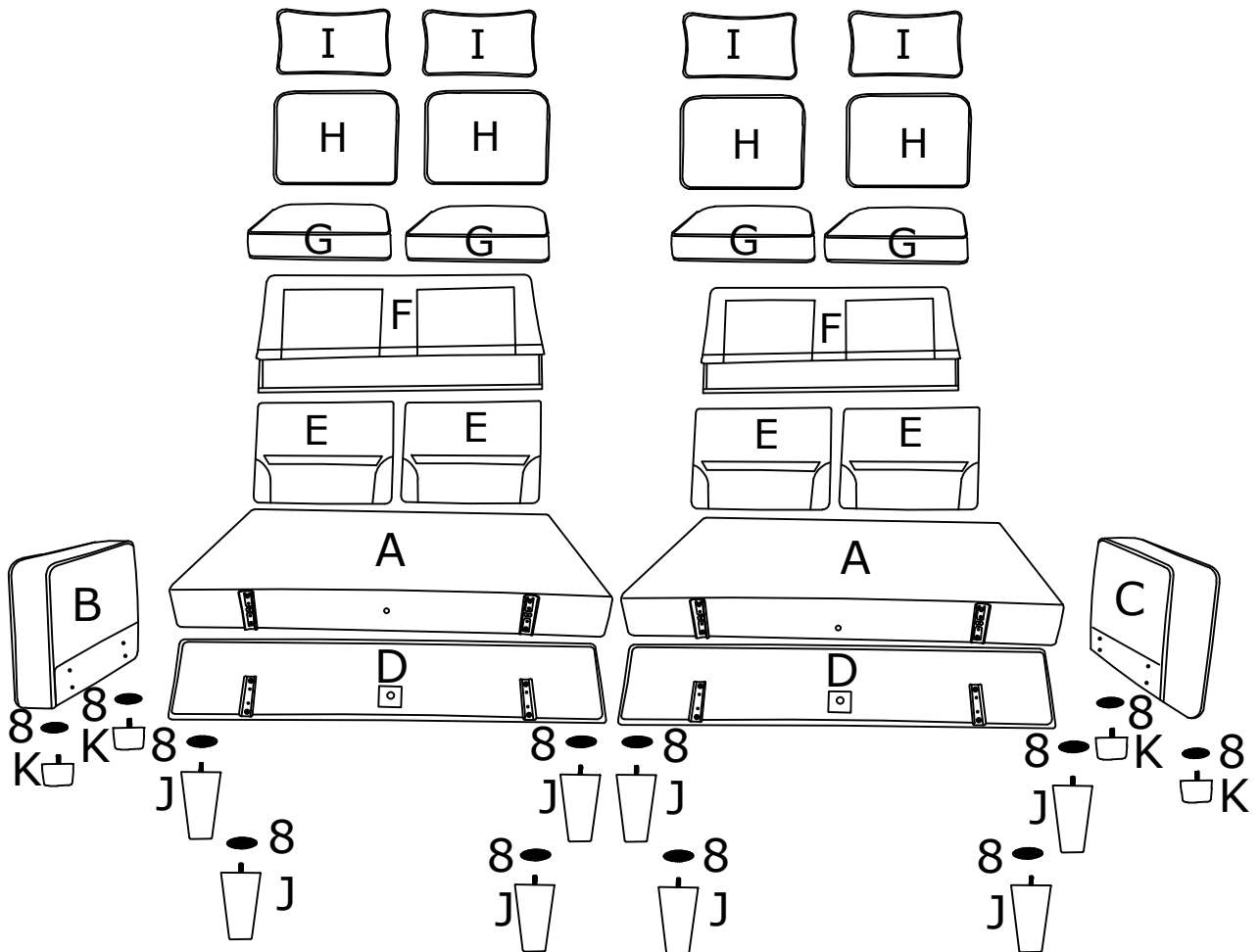

DIAGRAM 1 (Take all parts)

Take the Front baffle(Parts D)Back frame(Parts E)Back cover(Parts F)Seat cushion(Parts G)
Back cushion(big)(Parts H)Back cushion(small)(Parts I)Leg(big)(Parts J)Leg(small)(Parts K)
out of the Seat frame(Parts A).

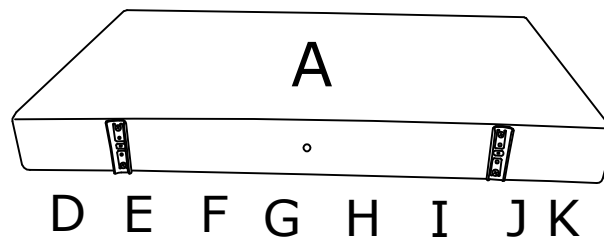

DIAGRAM 2 (Assemble the Legs)

Connect the 12 Plastic gasket (Hardware 8)8 Legs(big) (Parts J)and 4 Legs Leg(small)(Parts K)with the Seat frame (Parts A) with the Armrest (left) (Parts B) with the Armrest (right) (Parts C).

8		12PCS
J		8PCS
K		4PCS

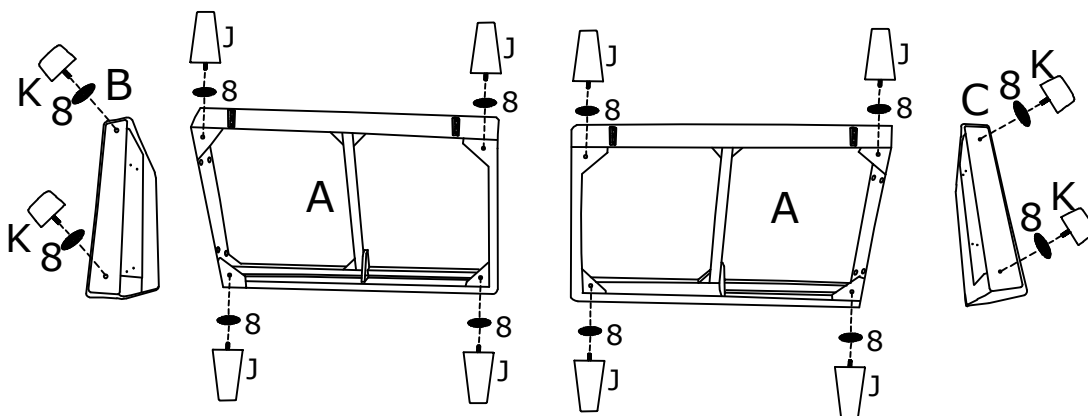

DIAGRAM 3 (Assemble the Seat frame and Front baffle)

Connect the Seat frame (Parts A) and Front baffle (Parts D).

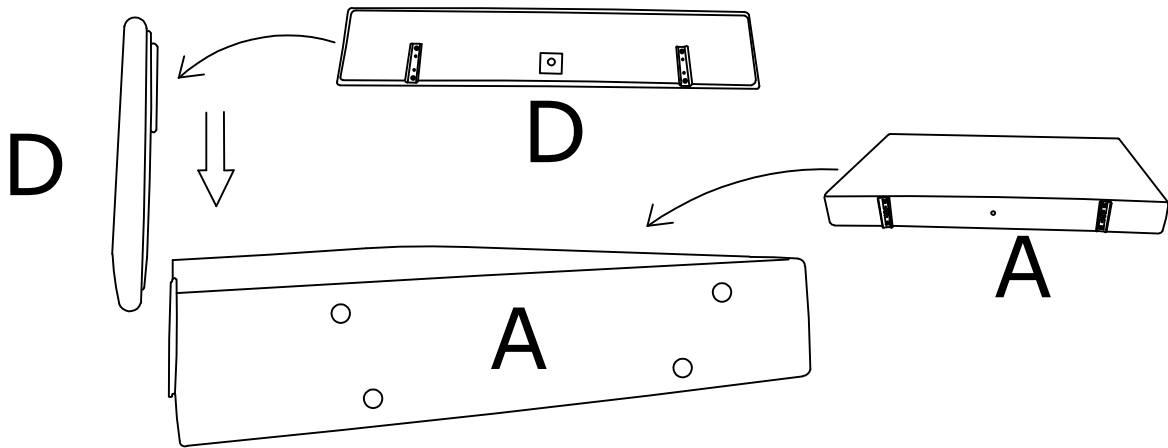



DIAGRAM 4 (Assemble the Seat frame and Front baffle)

Connect the Seat frame(Parts A) to the Front baffle (Parts D) with the Washer (Hardware 1) and the Screws M6X35(Hardware 2) by Wrench(Hardware 7).

1		1PCX2
2	 M6X35	1PCX2

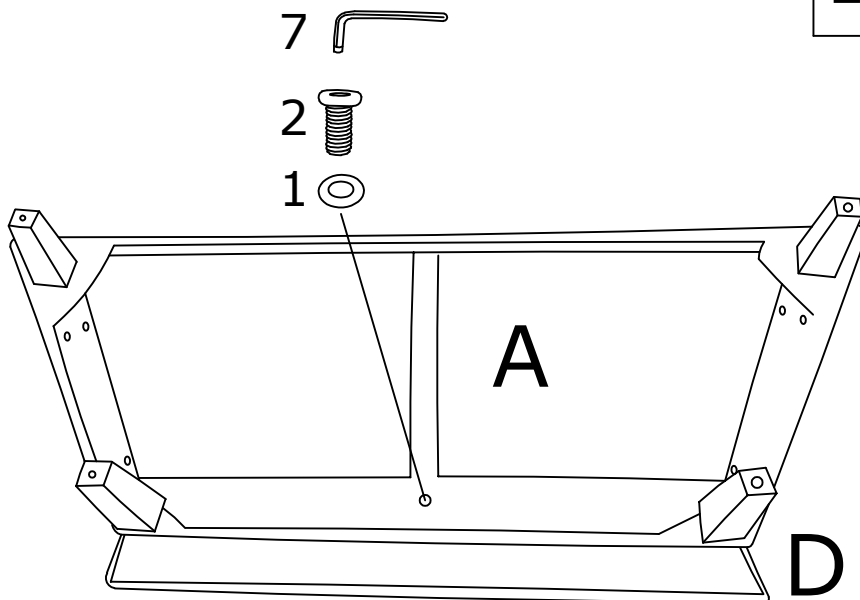



DIAGRAM 5 (Assemble the Armrest to the Seat frame)

Connect the Armrest (left) (Parts B) to the Seat frame (Parts A) with the Washer (Hardware 1) and the Screws M8X60(Hardware 4) by Wrench(Hardware 7).

1		4PCS
4	 M8X60	4PCS

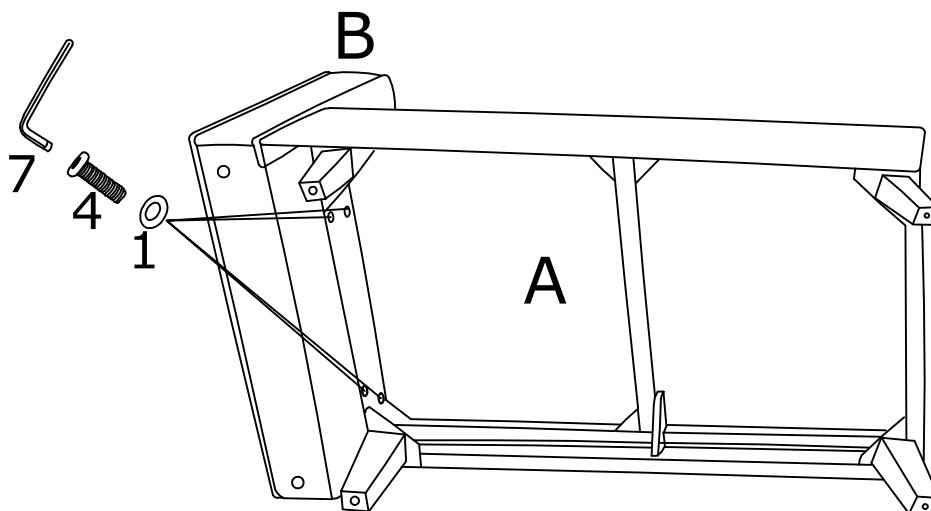



DIAGRAM 6 (Assemble the Armrest to the Seat frame)

Connect the Armrest (right) (Parts C) to the Seat frame(Parts A) with the Washer (Hardware 1) and the Screws M8X60(Hardware 4) by Wrench(Hardware 7).

1		4PCS
4	 M8X60	4PCS

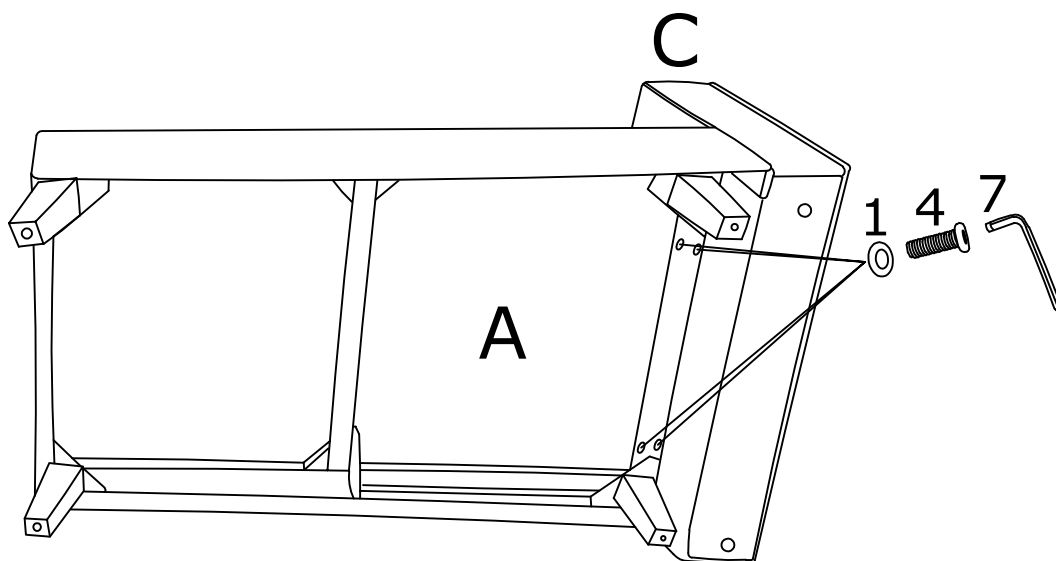





DIAGRAM 7 (Assemble the Seat frame)

Connect the Seat frame (Parts A)with the Seat frame (Parts A) tighten the Screws M8X80(Hardware 5) with the Butterfly nuts (Hardware 6)and Washer(Hardware 1)by Wrench(Hardware 7).

1		4PCS
5	 M8X80	2PCS
6		2PCS

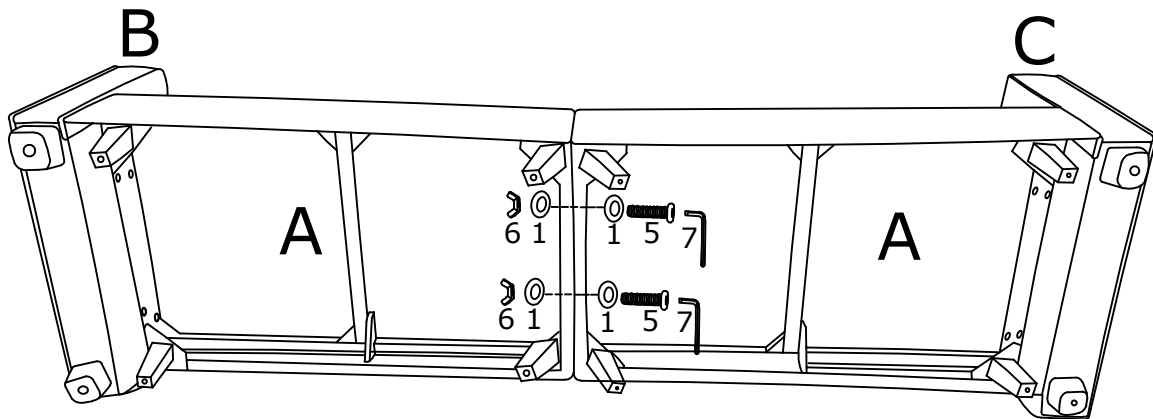





DIAGRAM 8 (Assemble the Back frame)

Connect the Back frame (Parts E)with the 8 Screws M8X40 (Hardware 3) and tighten the 8 Screws M8X60(Hardware 4) with the Washer(Hardware 1) by wrench (Hardware 7).

1		16PCS
3	 M8X40	8PCS
4	 M8X60	8PCS

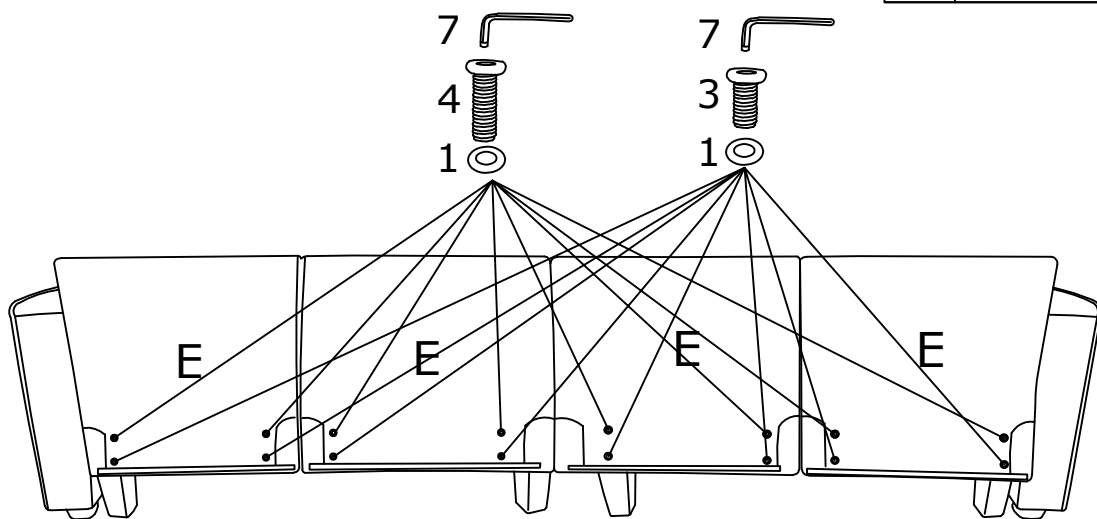
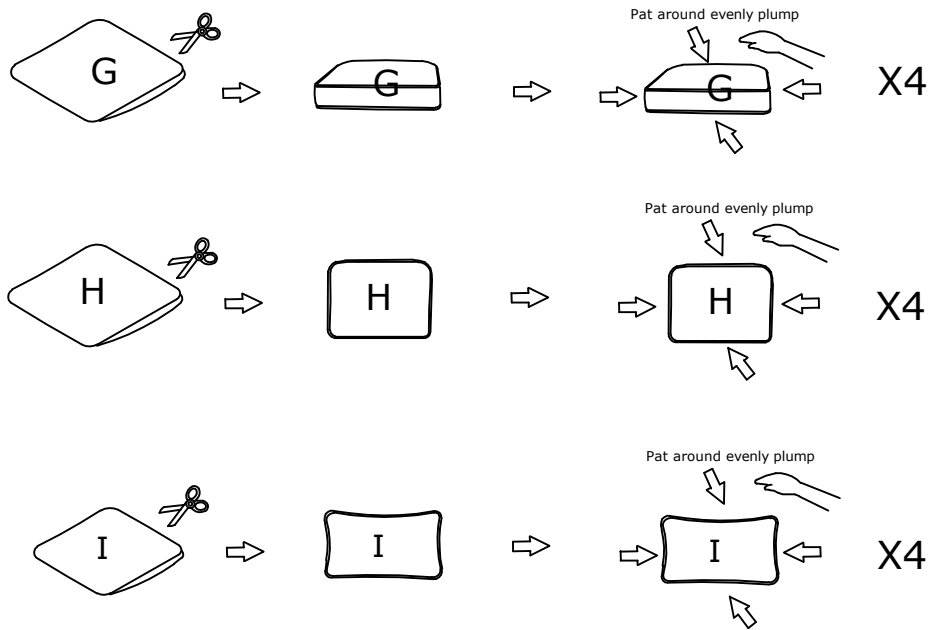

DIAGRAM 9 (Removal of compression bags)

Remove the Seat cushion(Parts G)the Back cushion(big)(Parts H) the Back cushion(small)(Parts I).



TIPS:

1. Please do not open the compressed packages until your sofa frame is completely assembled.
2. Compressed back cushions and pillows need to be fully fulfilled within 72 hours for your perfect use.
3. Please keep children away from plastic bags or any small pieces of stuff.

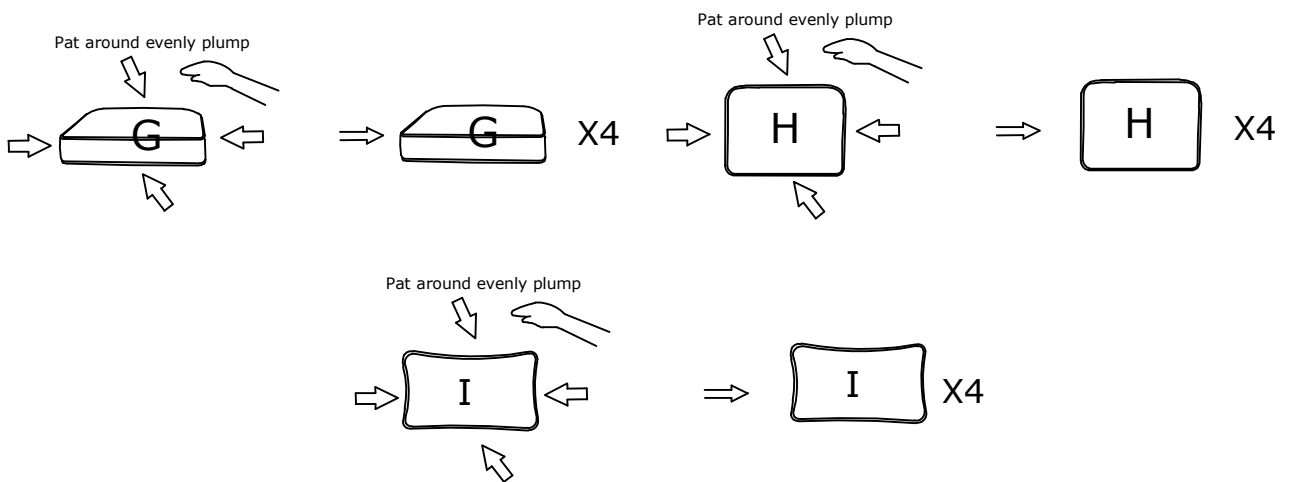

DIAGRAM 10 (Place the Back cover on the sofa)

Put the Back cover (Parts F).

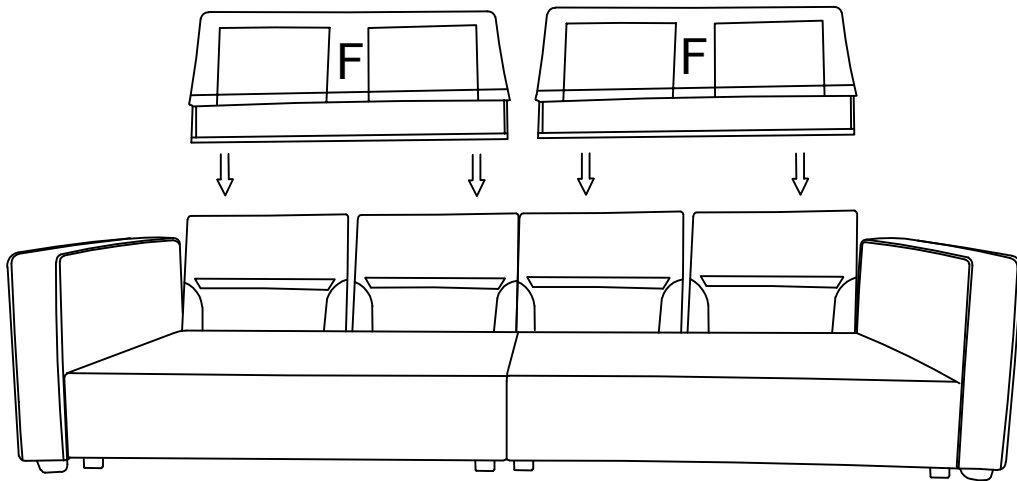

DIAGRAM 11 (Place the Seat cushion on the sofa)

Put the Seat cushion (Parts G).

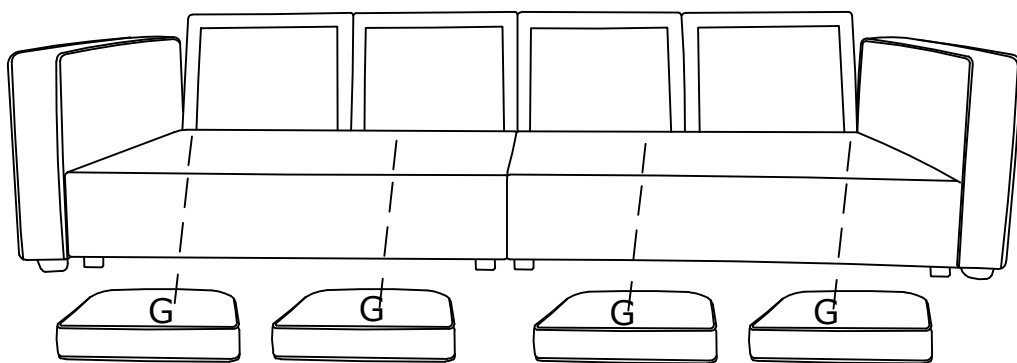
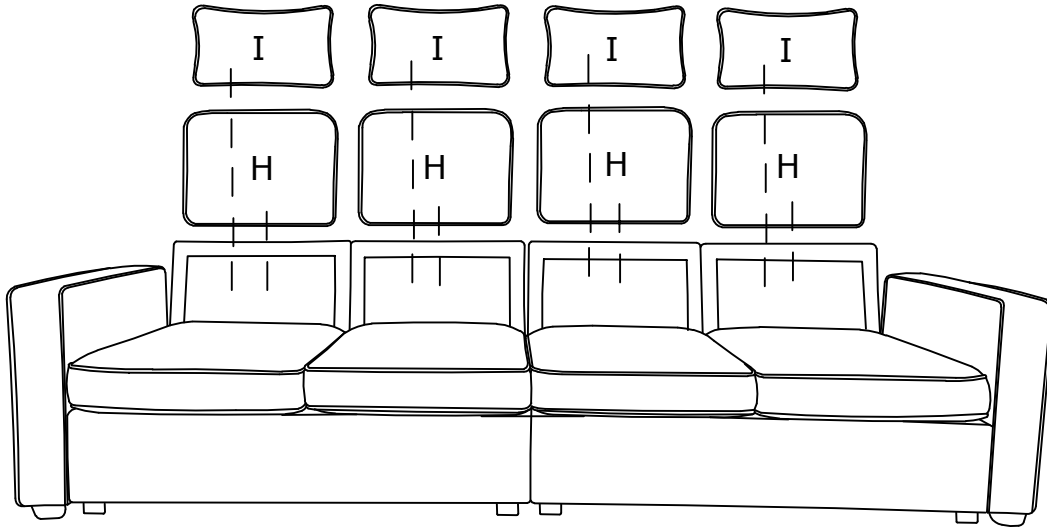

DIAGRAM 12 (Place the Back cushion(big) and Back cushion(small)on the sofa)

Put the Back cushion(big) (Parts H)and Back cushion(small) (Parts I) on the sofa.
Recheck all the bolts before you sit on the sofa.



TIPS:

1. Please do not open the compress packaging until your sofa frame is completely assembled.
2. Compress back cushions and pillows need to be fully fulfilled within 72 hours for your perfect use.
3. Please keep children away from plastic bags or any small pieces of stuff.

