

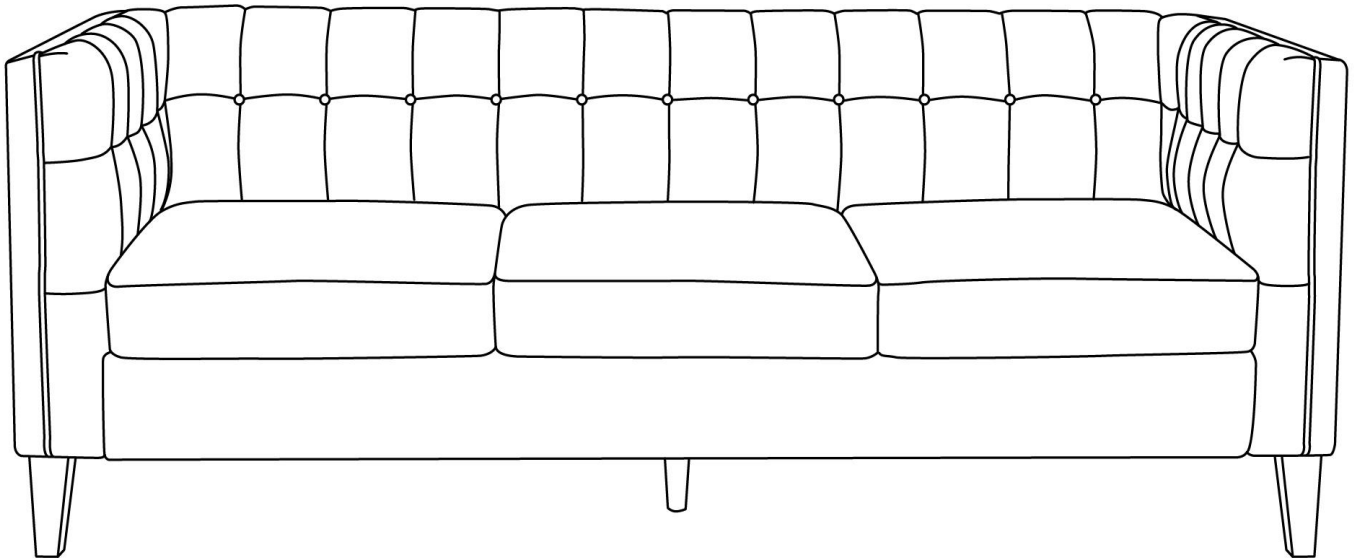



Assembly Instructions

Caution: You should read this carefully before you proceed



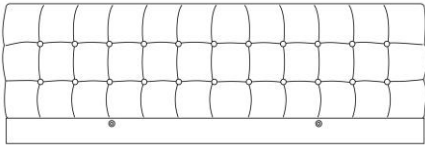
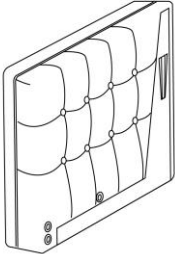
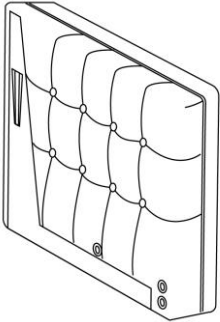
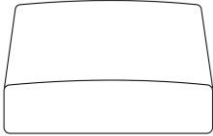



Sofa



Parts List

Label	Picture	Description	QTY
A		Backrest	1
B		Left Armrest	1
C		Right Armrest	1
D		Seat cushion	3
E		Seat Board	1
F		Frontal Seat Board	1
G		Sofa Leg	4
H		Middle Support Leg	1

Hardware

Label	Picture	Description	QTY
①		Bolt (M8*30MM)	9 (8pcs already fixed with Backrest & Armrest)
②		Gasket	8
③		Allen wrench(M8)	1
④		Bolt (M8*60MM)	3
⑤		Washer(M8)	3
⑥		Spring Washer(M8)	3

Assembly Preparation

Before Beginning Assembly:

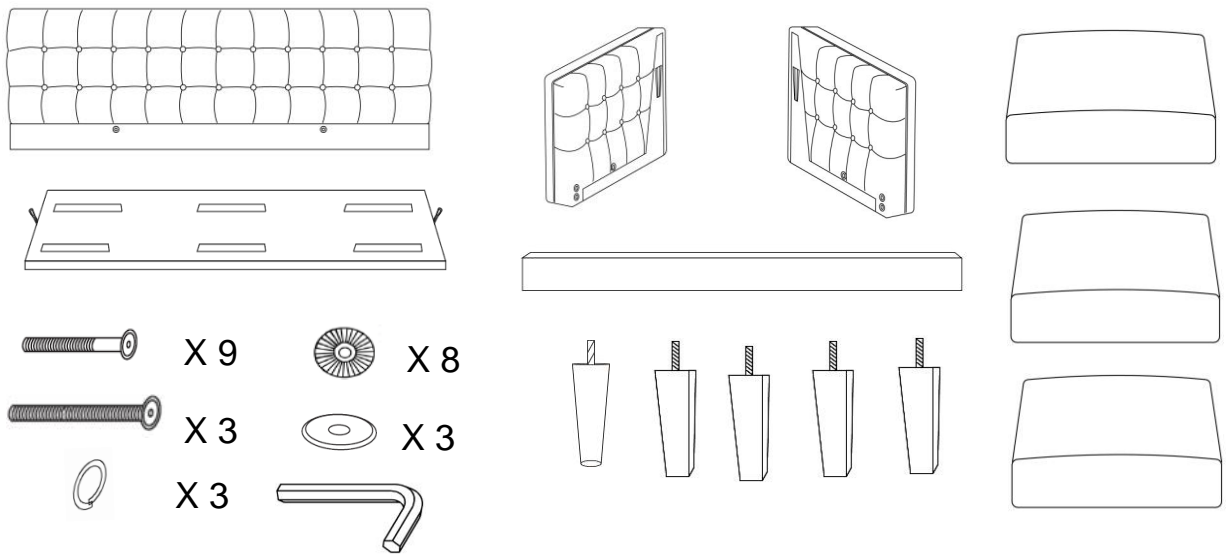

- Read instructions, cover to cover-



- Have 2 adults on hand for assembly-



- Do not assemble on flooring or carpet-



- Assemble on a clean non-marring surface (packing foam)-



- Save all packaging until finished-

Assembly Steps

Overview

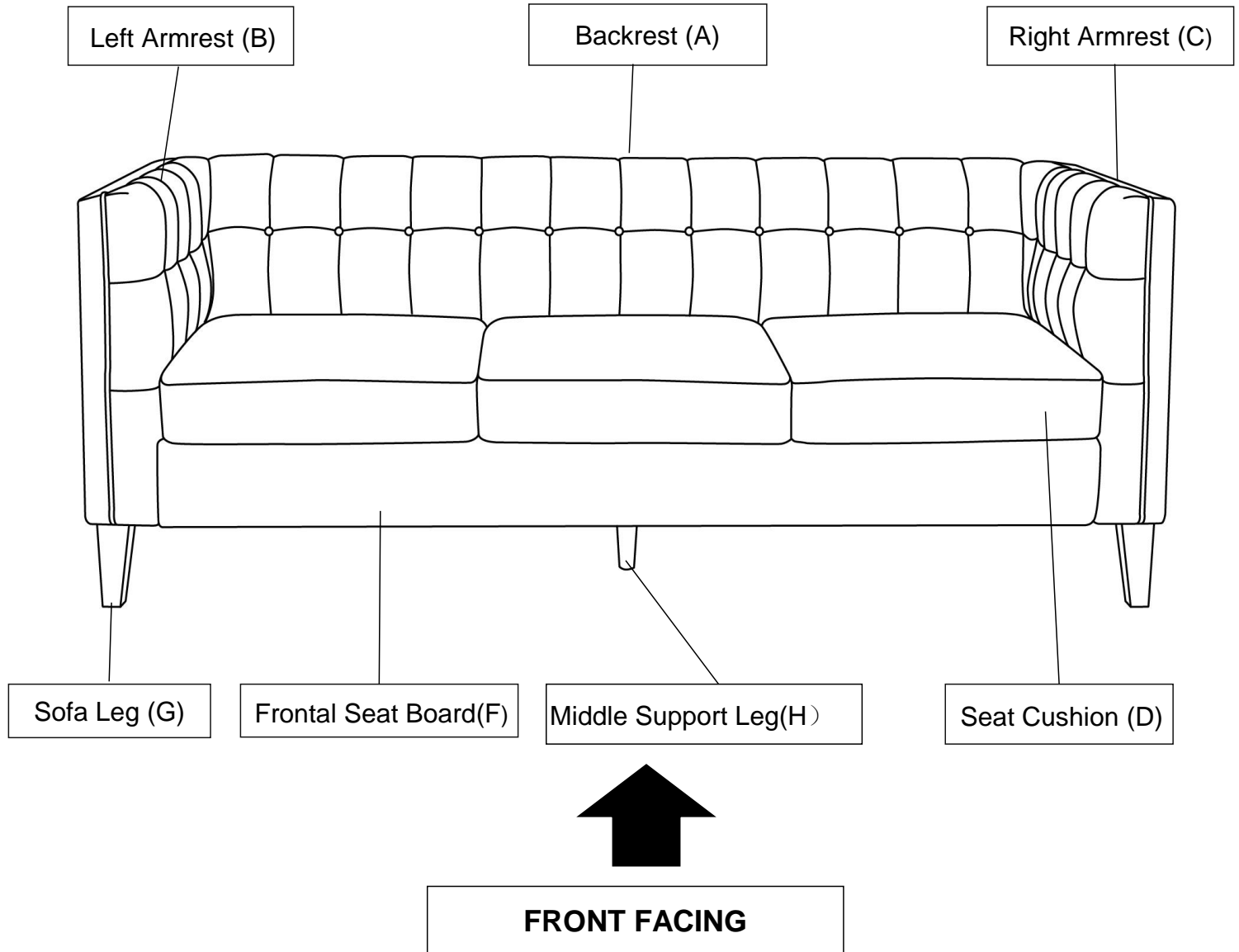

This Sofa has multiple parts and may require up to 60 minutes to assemble. To give you an overview of the Sofa parts, the above picture is provided to help you put the various parts into perspective. Please read through the instructions below to familiarise yourself with the parts and steps before assembly.

Note: It is recommended that you have an adult partner to assist you during the entire assembly process.

Step 1

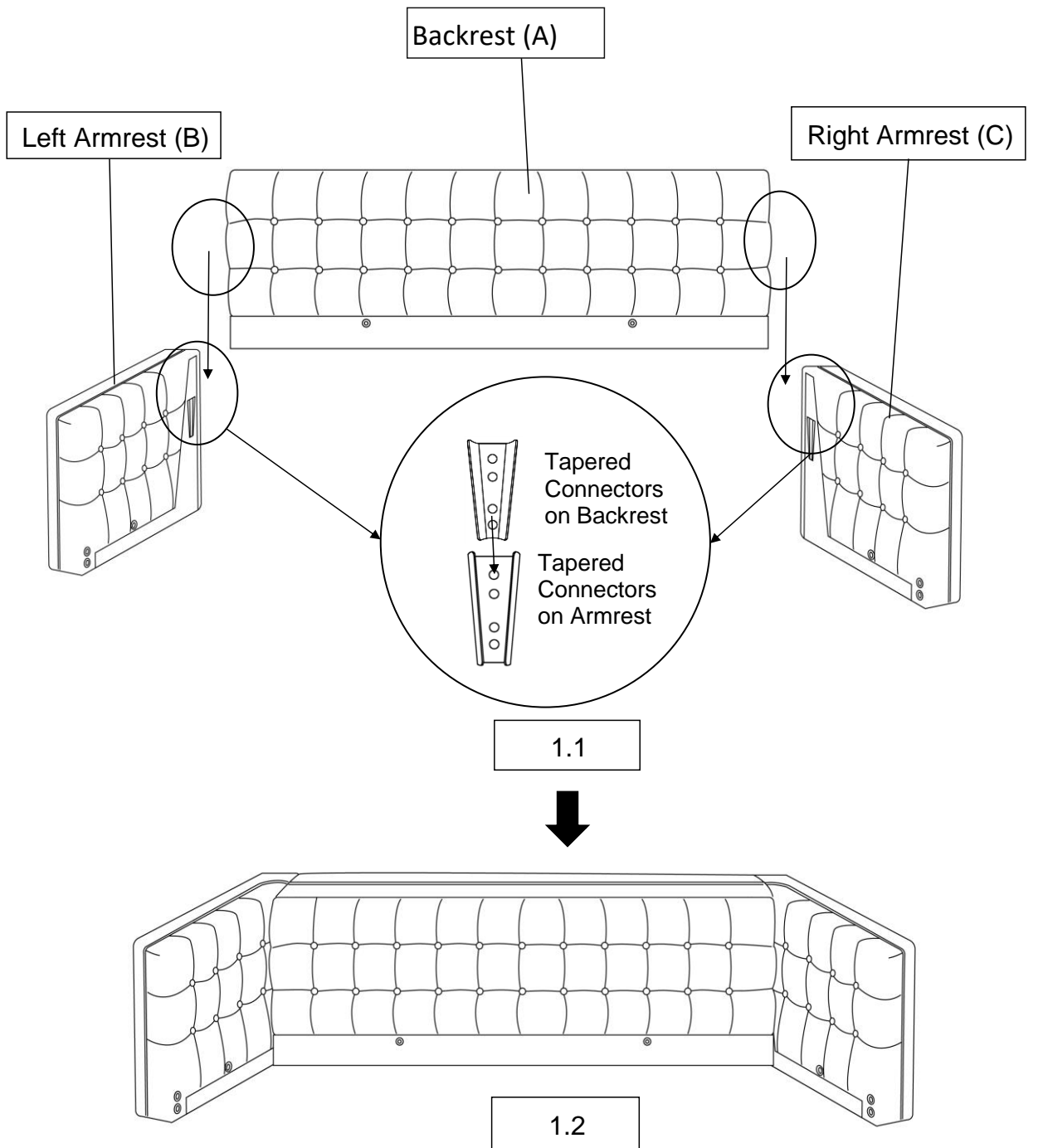

Open the carton and place all the parts on a clean, non-marring surface.

With the assistance from your adult partner:

1.1) Lift the Backrest(A) up, make sure the Backrest(A) is vertical and aligned to the Armrests.

Align the Tapered Connectors on the Backrest(A) with those on the Armrest(B&C).

Your adult partner may need to push the Armrests in towards the Backrest(A) to allow for better alignment.

Slip and Slide the Backrest, in a gradual and balanced manner into the Tapered Connectors.

1.2) Push the Backrest(A) downwards until it is fully slotted and locked into position.

Note: Make sure the Tapered Connectors on the Backrest(A) lock into the Tapered Connectors on Armrest(B&C) .

Fully locked position: Check and assess that the base of the Backrest(A) and Armrest(B&C) are aligned and level.

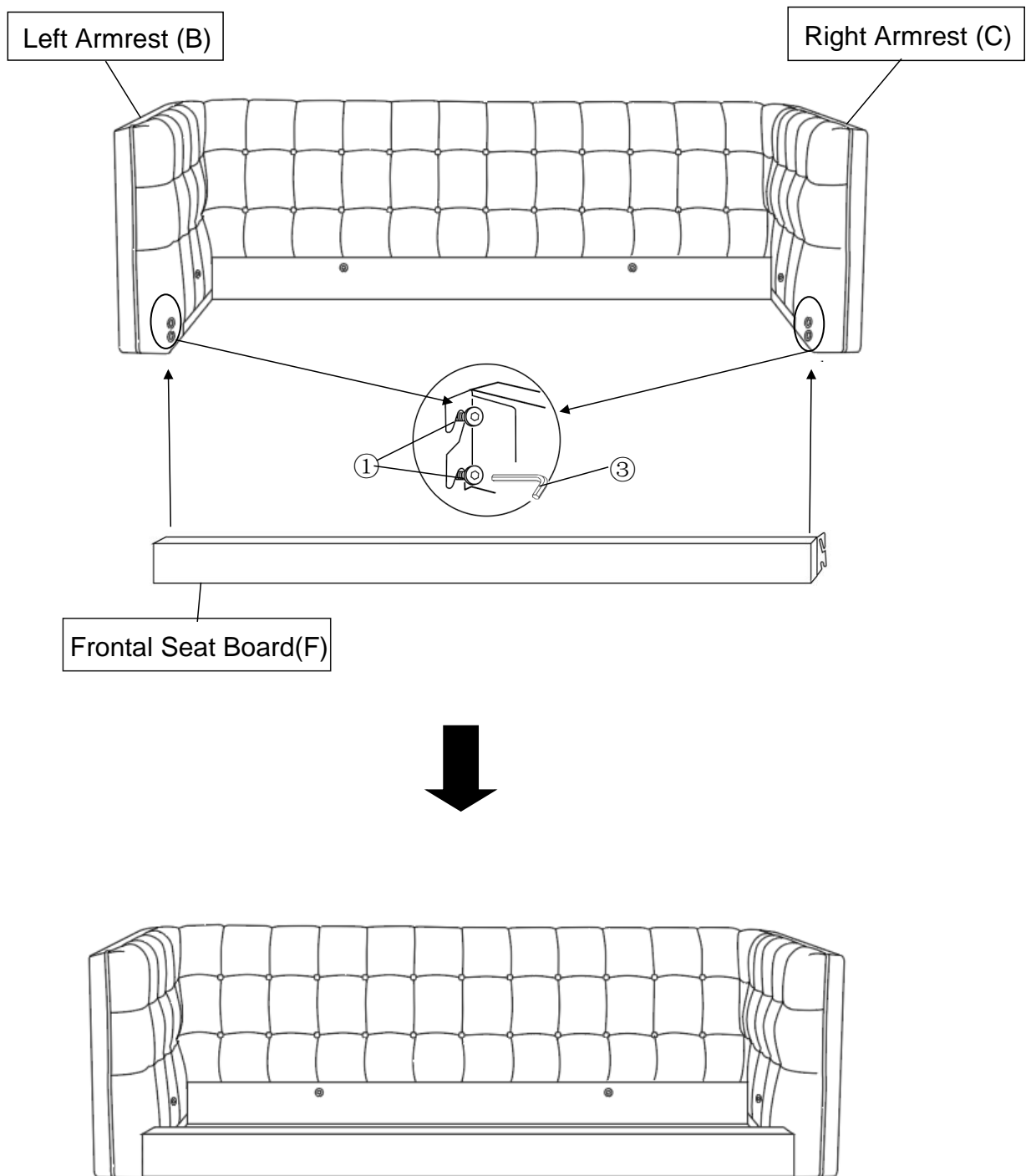

Using the Allen Wrench (③) and turning Counter-Clockwise, loosen all the Bolts (①) which are pre-assembled on the Backrest (A) and Armrests (B&C) about 3 threads out to make a small gap in which to fit the metal brackets.

Place the Frontal Seat Board (F) as shown in the above pictures in front of the semi-sofa from step 1, hang the Brackets on the Bolts found on the Armrests (B&C). Then use Allen Wrench (③), turning Colockwise to tighten the Bolts, ensure the brackets are tightly fitted onto the Bolts.

Step 3

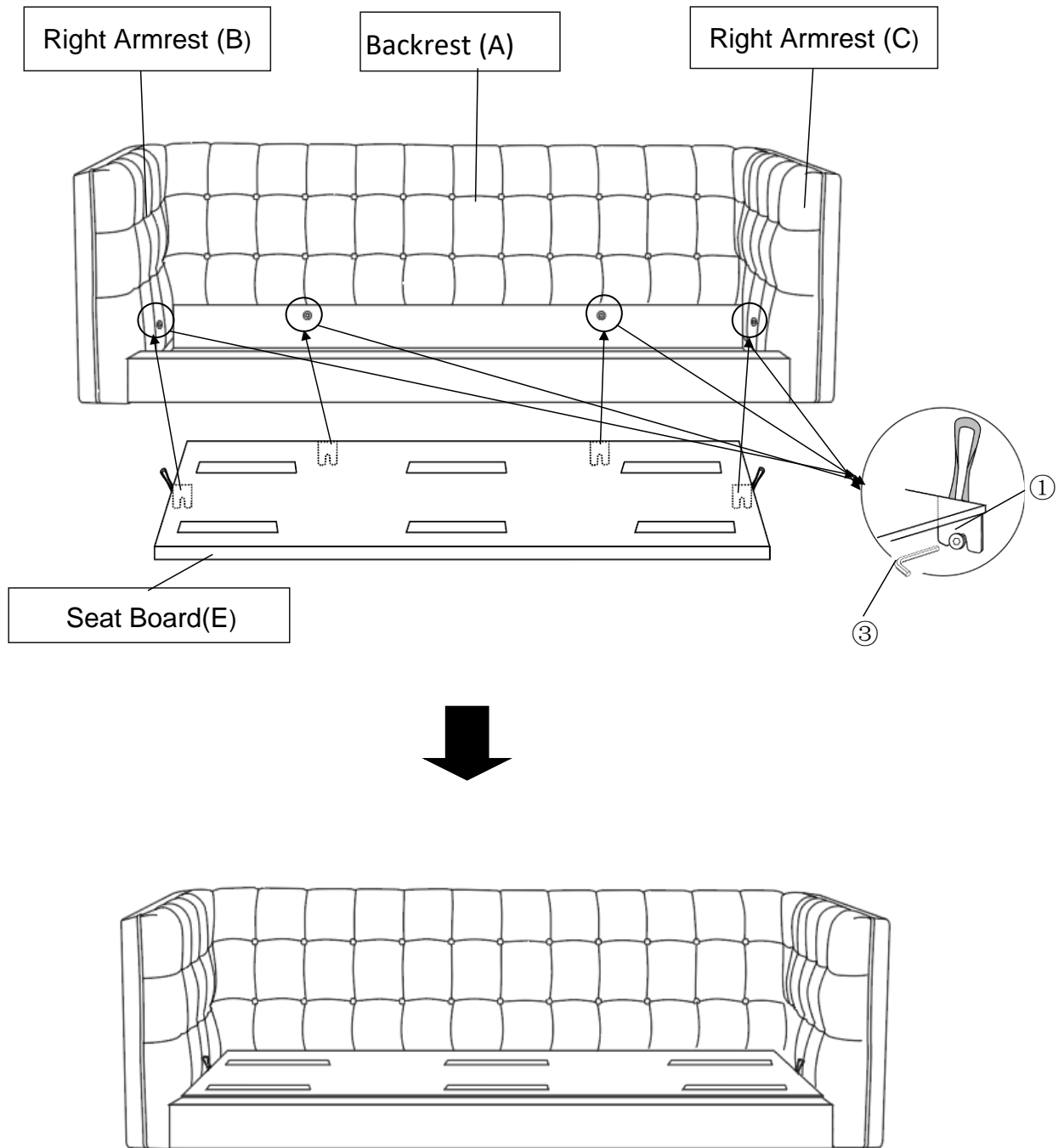

Pull on the hand traps and put the Seat Board (E) onto the semi-assembled sofa of step 2 as shown in the above pictures.

Insert the brackets on the board onto the Bolts. Then use the Allen Wrench (③) and turn Clockwise to tighten the Bolts, ensure the brackets are tightly fitted onto the Bolts.

Note: Be careful about the brackets on the Seat Board (E) during putting the board, do not scratch on the cover material of the Armrest.

Step 4

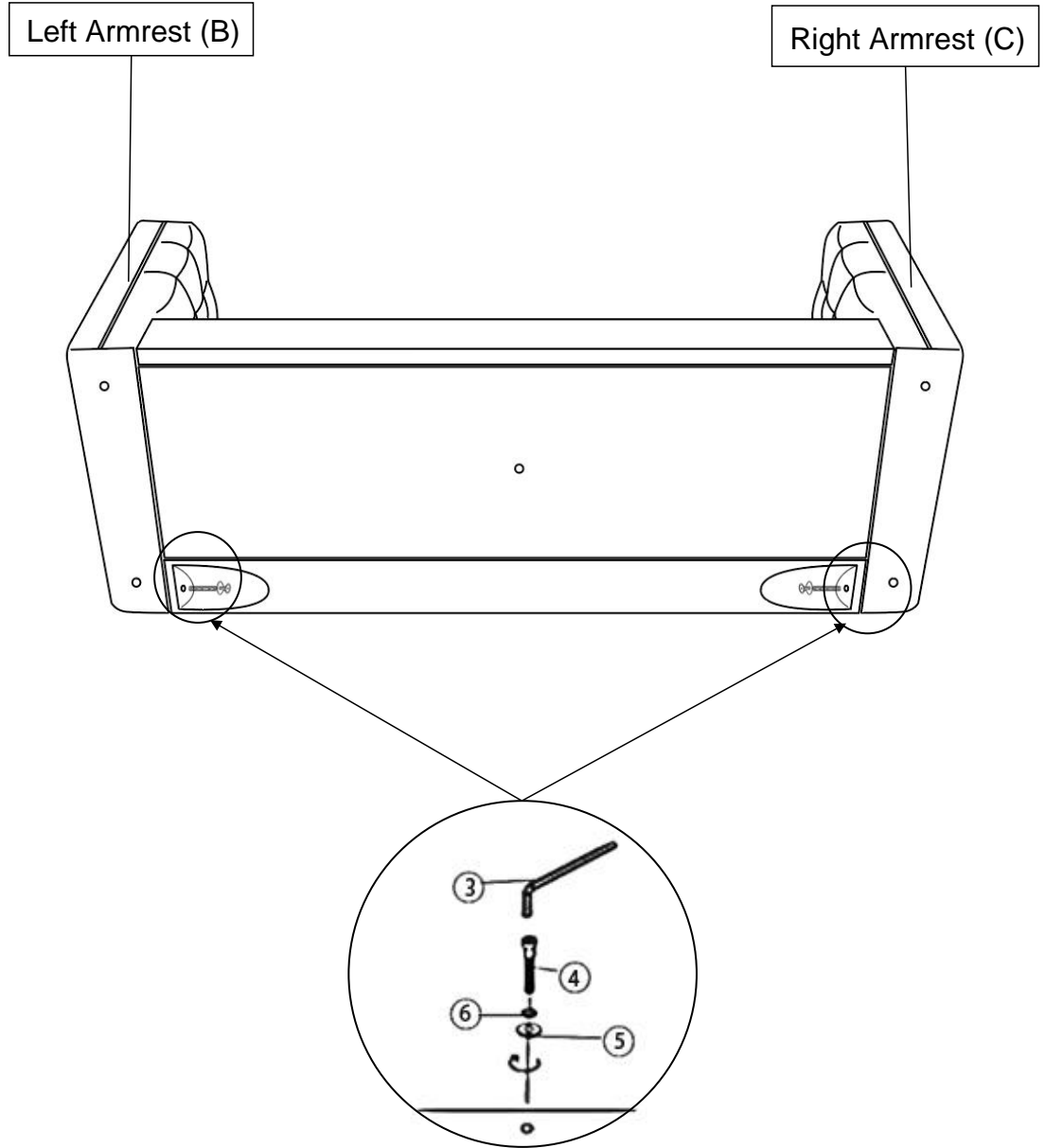

Tilt and lay the sofa on its Backrest(A) onto a flat surface.
Fix the Backrest(A) with Armrests (B&C) using Bolts(④), Spring Washers(⑥), and Washers(⑤) with the Allen wrench(③) as pictured above.
Tighten the Bolts fully in a sequential manner.

Step 5

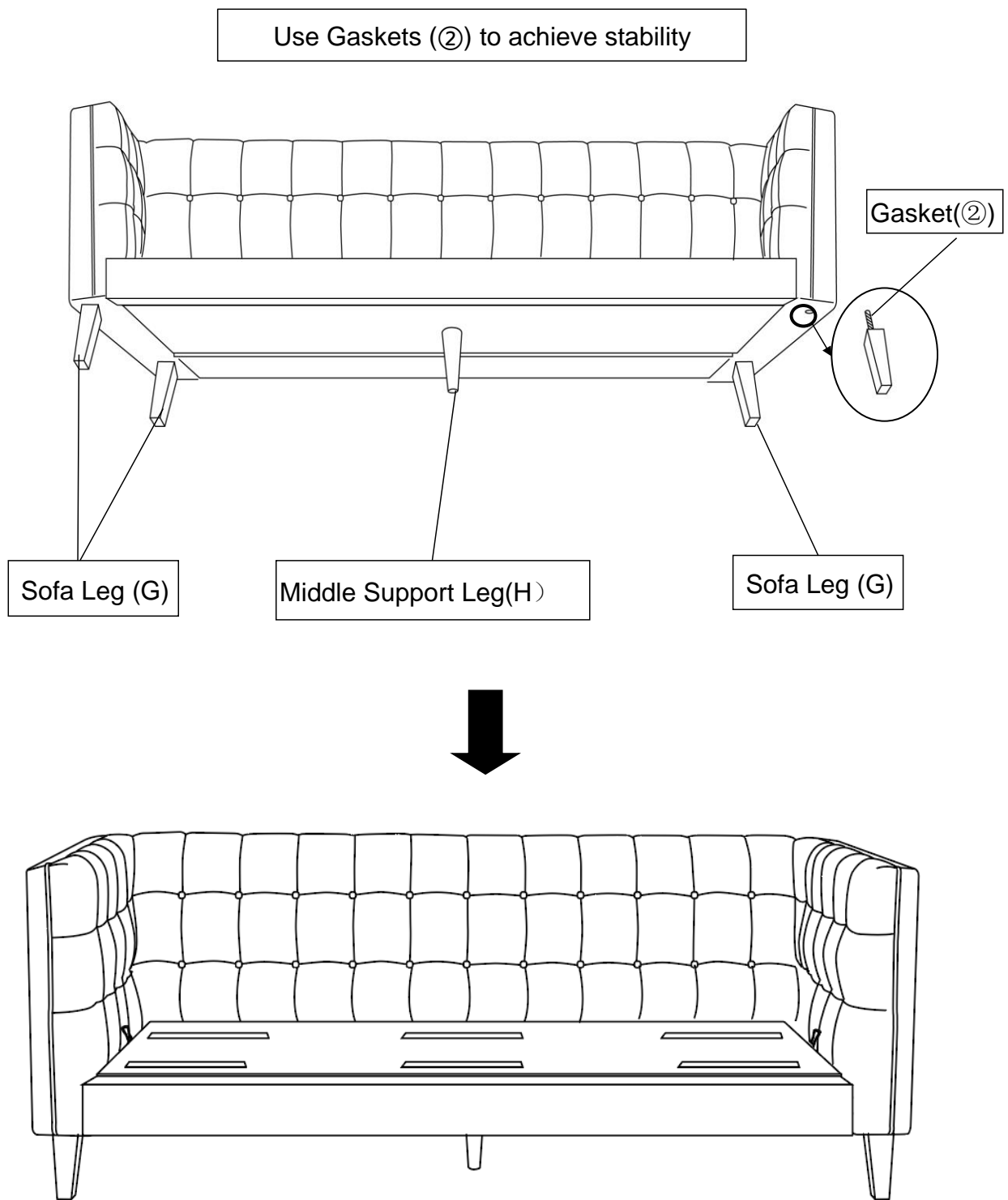

Attach the sofa Leg(G) to the bottom of the sofa by placing one Gasket(2) on the threaded stem. Then insert the threaded stem into the threaded mounting position at the corner of the sofa. Tighten by turning the Leg clockwise.

Repeat the same step to install the remaining four Legs.

Note: The use of Gaskets are OPTIONAL and are especially useful to help alleviate slight wobbles. Some Legs may need more than one while other legs may not need any.

Please keep the Allen key, as you may need it to tighten the Bolts again if the product were to loosen during use.

Step 5

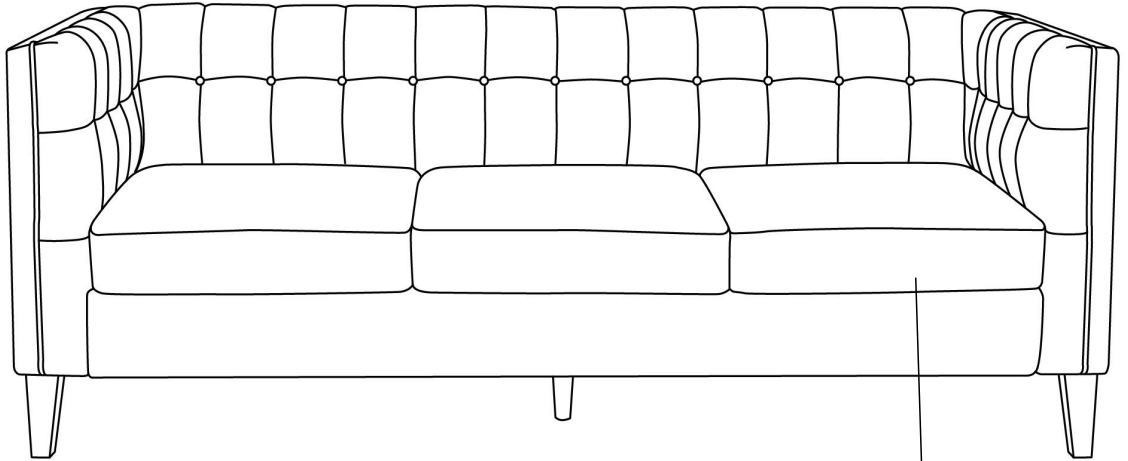

Seat Cushion (D)

Place the sofa in an upright position, then Place the Seat Cushions(D) onto the Sofa.
Your Sofa is ready for use.

This Sofa can only be used on a flat, level surface.

Care & Maintenance



- Furniture may scratch floors. We recommend using furniture pads to protect your floors.



- Do not put hot items directly on furniture surface.



- Do not clean furniture with harsh cleansers or polish.



- Do not place furniture under direct sunlight.



- Do not place furniture near heating or cooling vents.



- Do not write on furniture without a padded barrier to protect the surface.



- Do not place furniture outside . For indoor use only.



- Not for commercial use. For residential use only.



- Stains may be removed with mild soap solution and damp cloth.



- Children should not climb or jump on the furniture.



- Dust and pick-up spills using a clean, non-colored, lint-free cloth.