

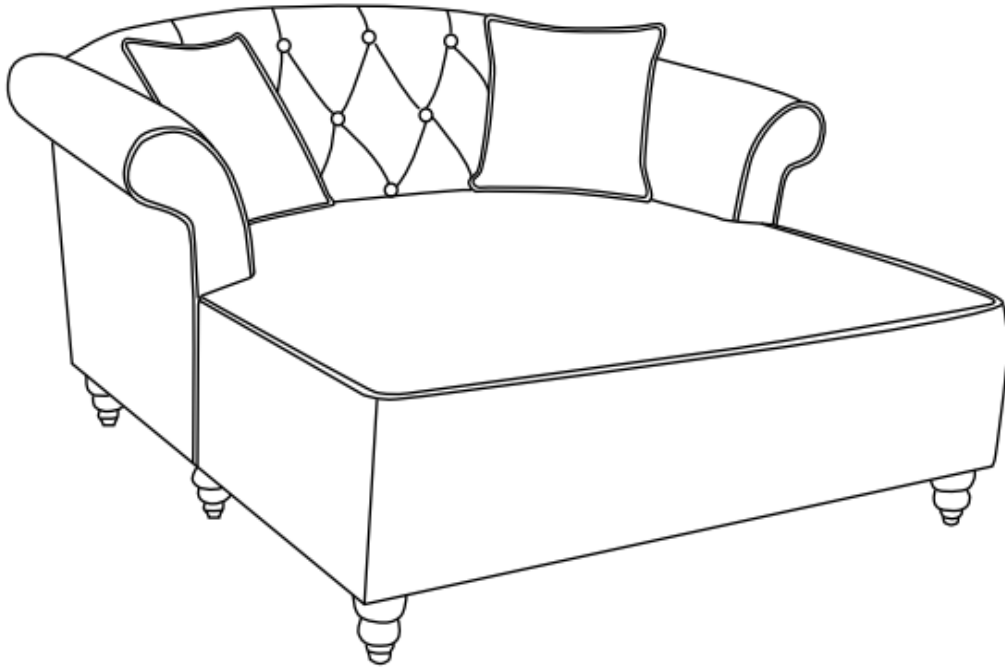



Assembly Instructions

Caution: You must read this before you proceed



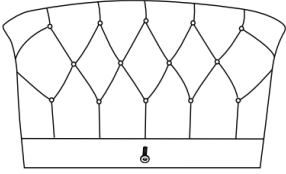
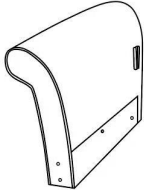

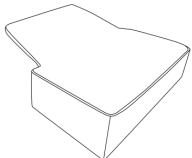
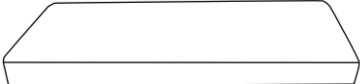
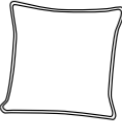
LOVESEAT CHAISE LOUNGE



Part List

Label	Picture	Description	QTY
A		Backrest	1
B		Left Armrest	1
C		Right Armrest	1
D		Iron Seat Frame	1
E		Seat	1
F		Seat Cushion	1
G		Back Cushion	2
H		Leg	6

Hardware

Label	Picture	Description	QTY
①		Bolt (M8*60MM)	7
②		Flat Washer	7
③		Plastic Washer	9
④		Allen Wrench	1
⑤		Spring Washer	7

Assembly Preparation

Before Beginning Assembly:

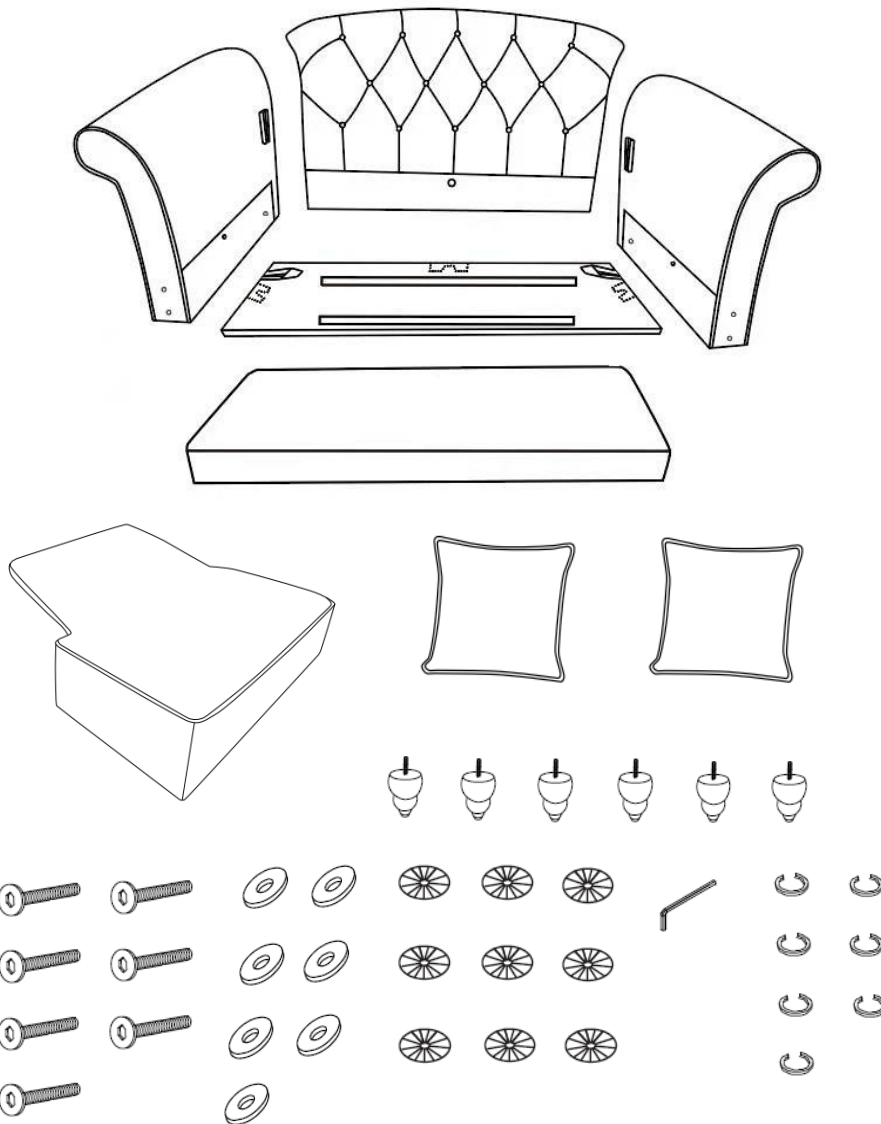



- Read instructions, cover to cover-



- Have 2 adults on hand for assembly-



- Do not assemble on flooring or carpet-



- Assemble on a clean non-marring surface (packing foam)-



- Save all packaging until finished-

Assembly Steps

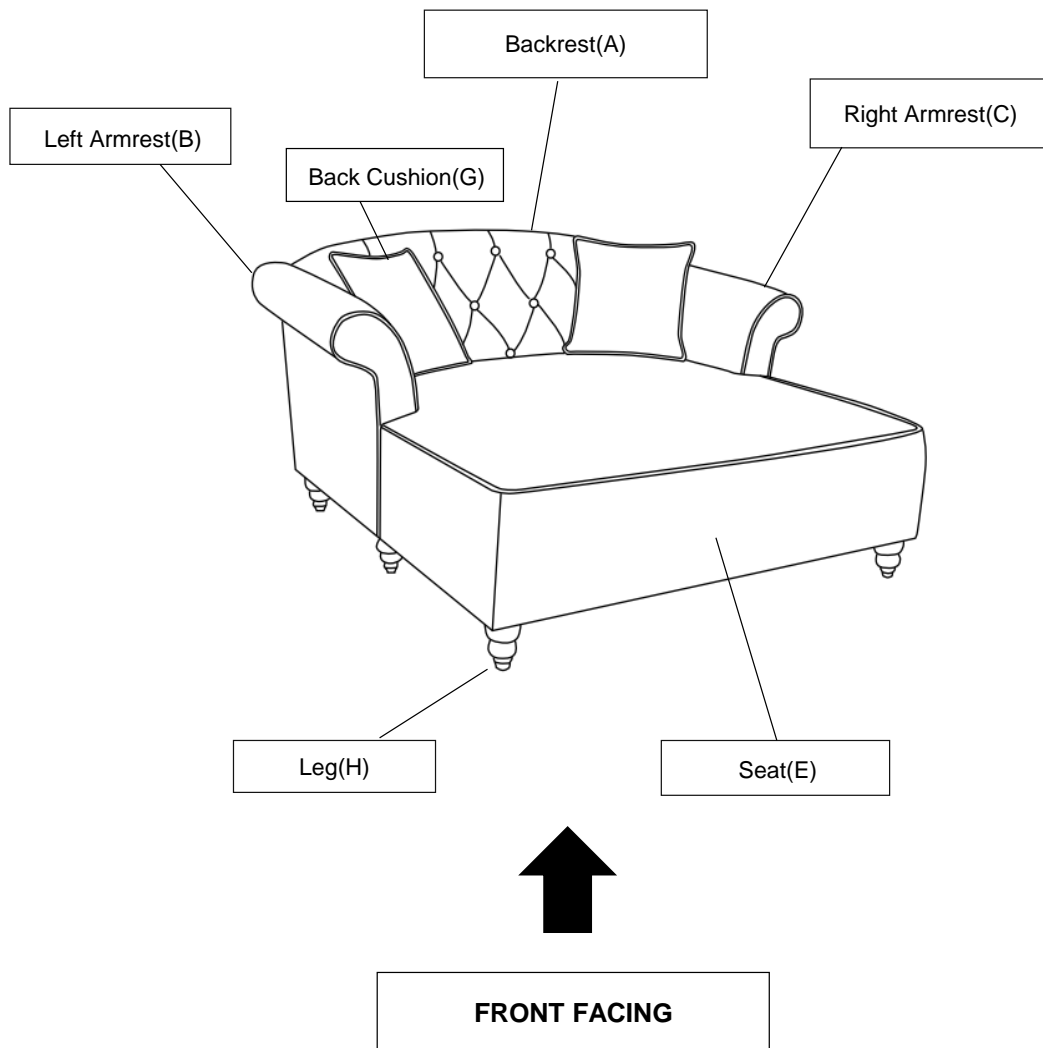

This Loveseat Chaise Lounge has multiple parts and may require up to 60 minutes to assemble. To give you an overview of the Loveseat Chaise Lounge parts, the above picture is to help you put the various parts into perspective. Please read through the instructions below to familiarise yourself with the parts and steps before assembly.

Note: It is recommended that you have an adult partner to assist during the entire assembly process.

Step 1

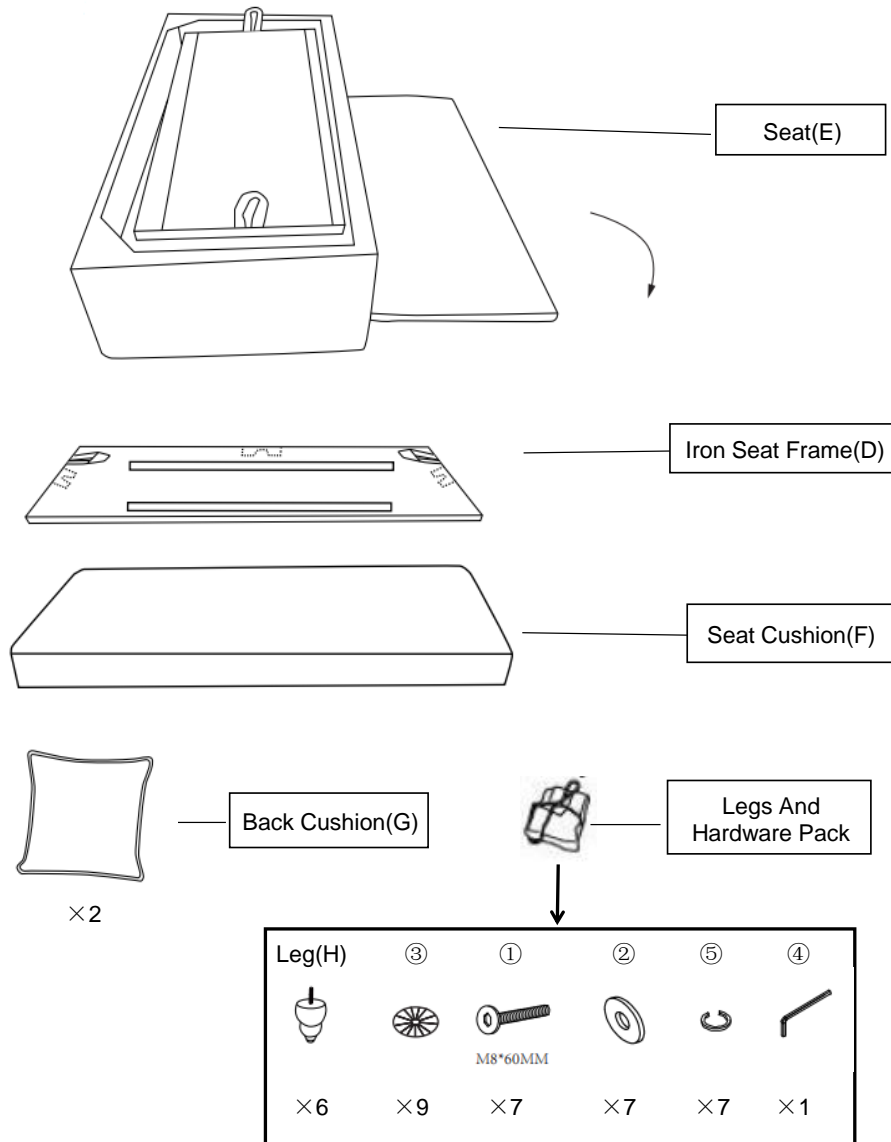

Remove the Iron Seat Frame(D), Seat Cushion(F), Back Cushion(G) and Legs And Hardware Pack from the Seat(E).

Step 2

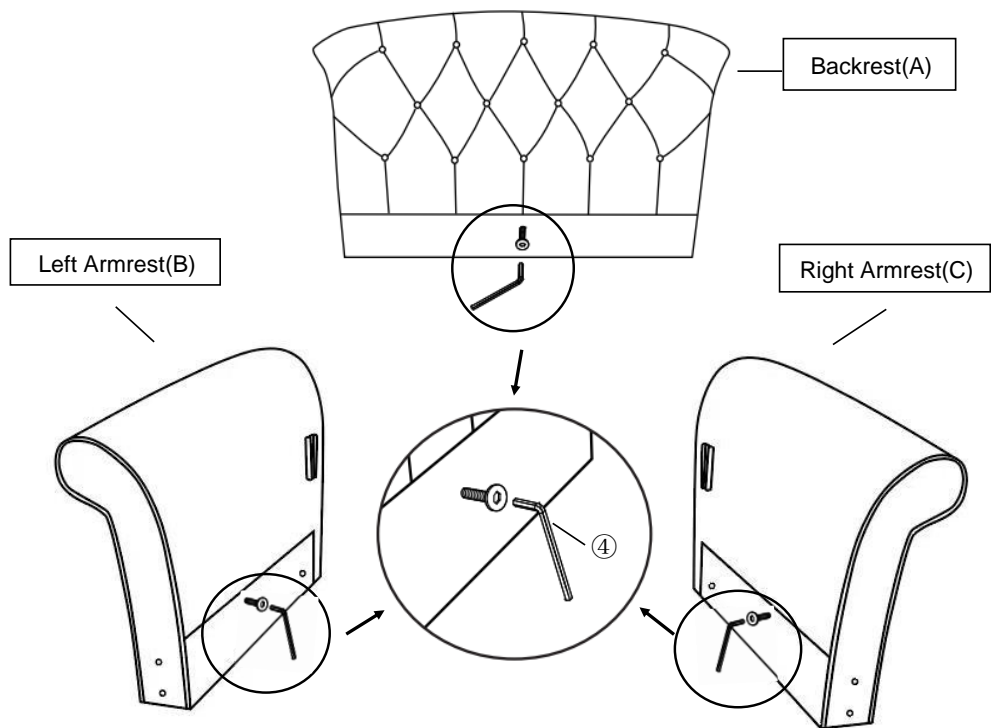

Unscrew the Bolts on the Left Armrest(B), Right Armrest(C) and the Backrest(A) with the Allen Wrench(④) as shown.

Step 3

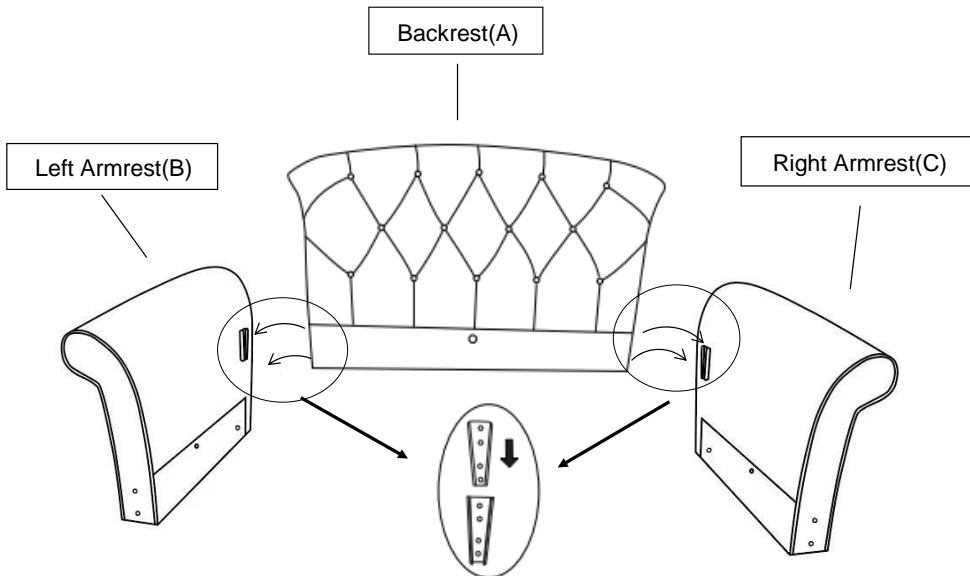

With the assistance of your partner, insert the Tapered Connectors on the Backrest(A) into the Tapered Connectors on the Left Armrest(B) as shown in the picture. Repeat the same process with the Right Armrest(C).

Note: Make sure the Tapered Connectors on Left Armrest(B) and Right Armrest(C) lock into the Tapered Connectors on the Backrest(A).

Assistance from an adult partner is needed for this assembly process.

During this assembly process - do exercise caution. You may need to use your hand to press down and or pave away the padded surface to facilitate the 'slip and slide' assembly.

Caution: Ensure that your fingers do not get caught or pinched in the assembly process.

Step 4

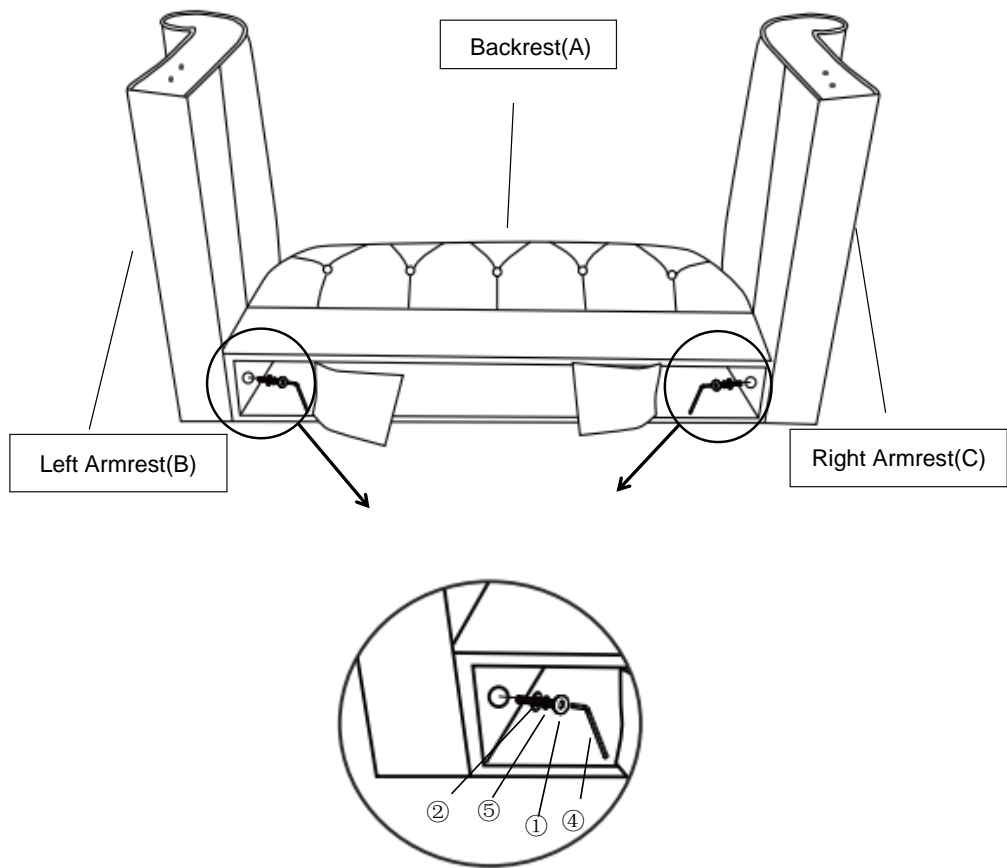

Tilt and lay the Loveseat Chaise Lounge on its Backrest(A) on a flat surface. Open the magic tape at the bottom of Backrest(A).

Attach the Backrest(A) to Left Armrest(B) and Right Armrest(C) using Bolts(①), Spring Washers(⑤), and Flat Washers(②) with Allen Wrench(④).

DO NOT fully tighten a Bolt in one go and then move on to the next.

Rather, In a sequential manner, gradually tighten each Bolt until all Bolts are evenly secured.

This methodology will ensure maximum evenness once all Bolts are fully tightened.

Step 5

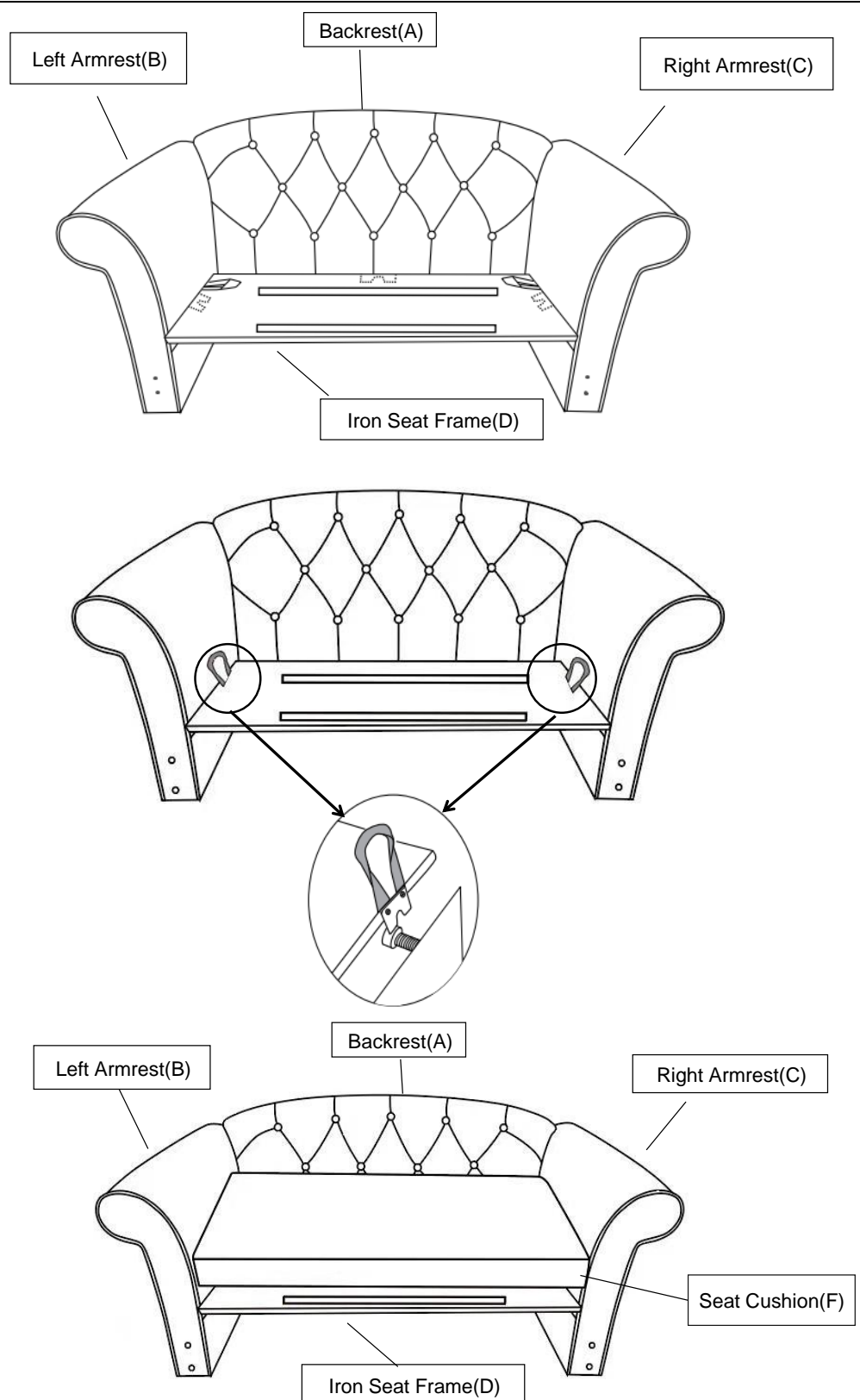

With the assistance of your partner, lift the rope on the two sides of Iron Seat Frame(D) by hand. Put the Iron Seat Frame(D) on the inside of Backrest(A), Left Armrest(B) and Right Armrest(C), and then slowly place it down as shown above. Make sure that all the u-shaped iron sheet need clamped to the bolt. Put the Seat Cushion(F) on the Iron Seat Frame(D).

Step 6

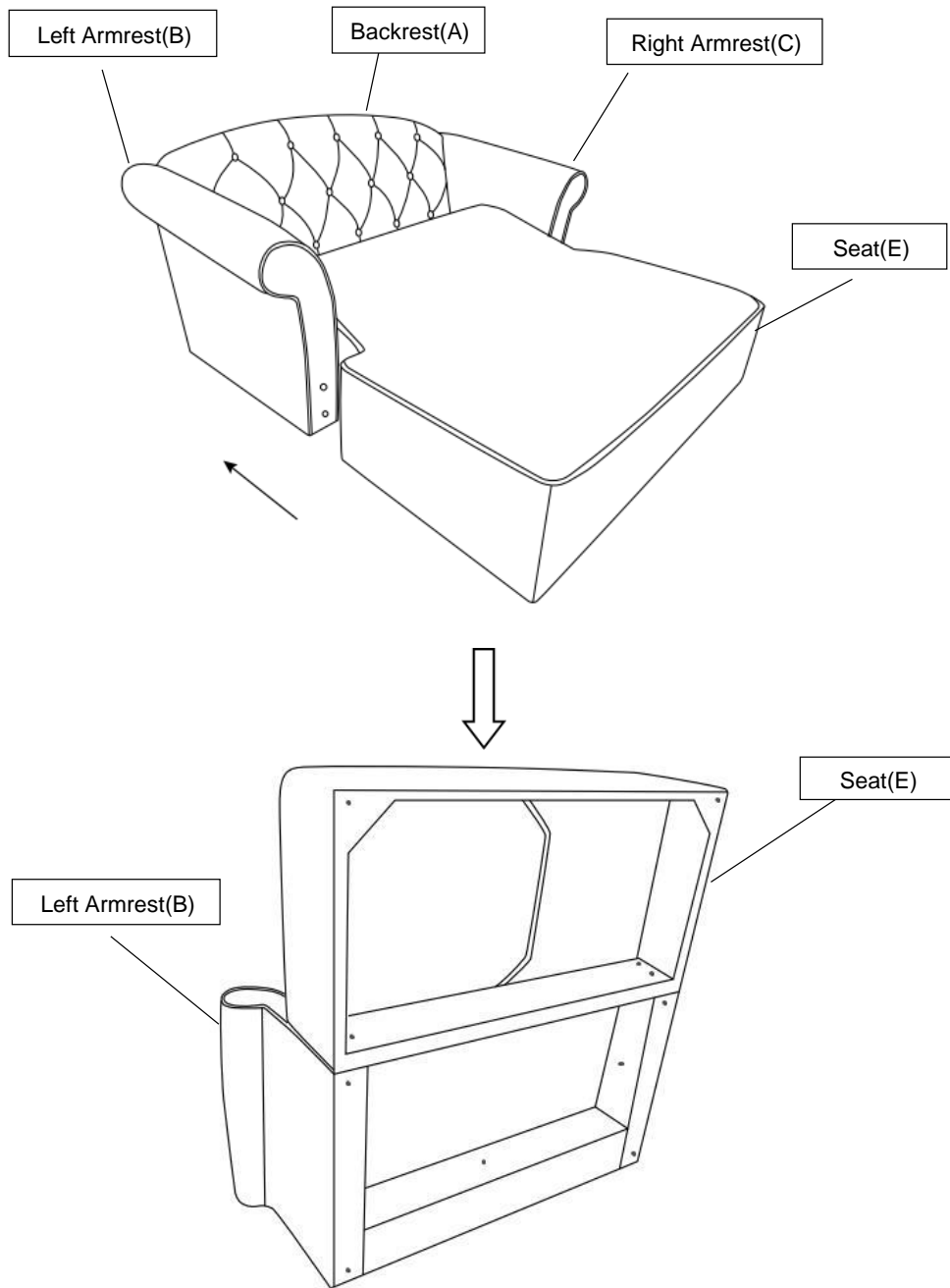

Combine the Seat (E) to the position shown in the figure.
Tilt and lay the Loveseat Chaise Lounge on its Backrest(A) onto a flat surface.

Step 7

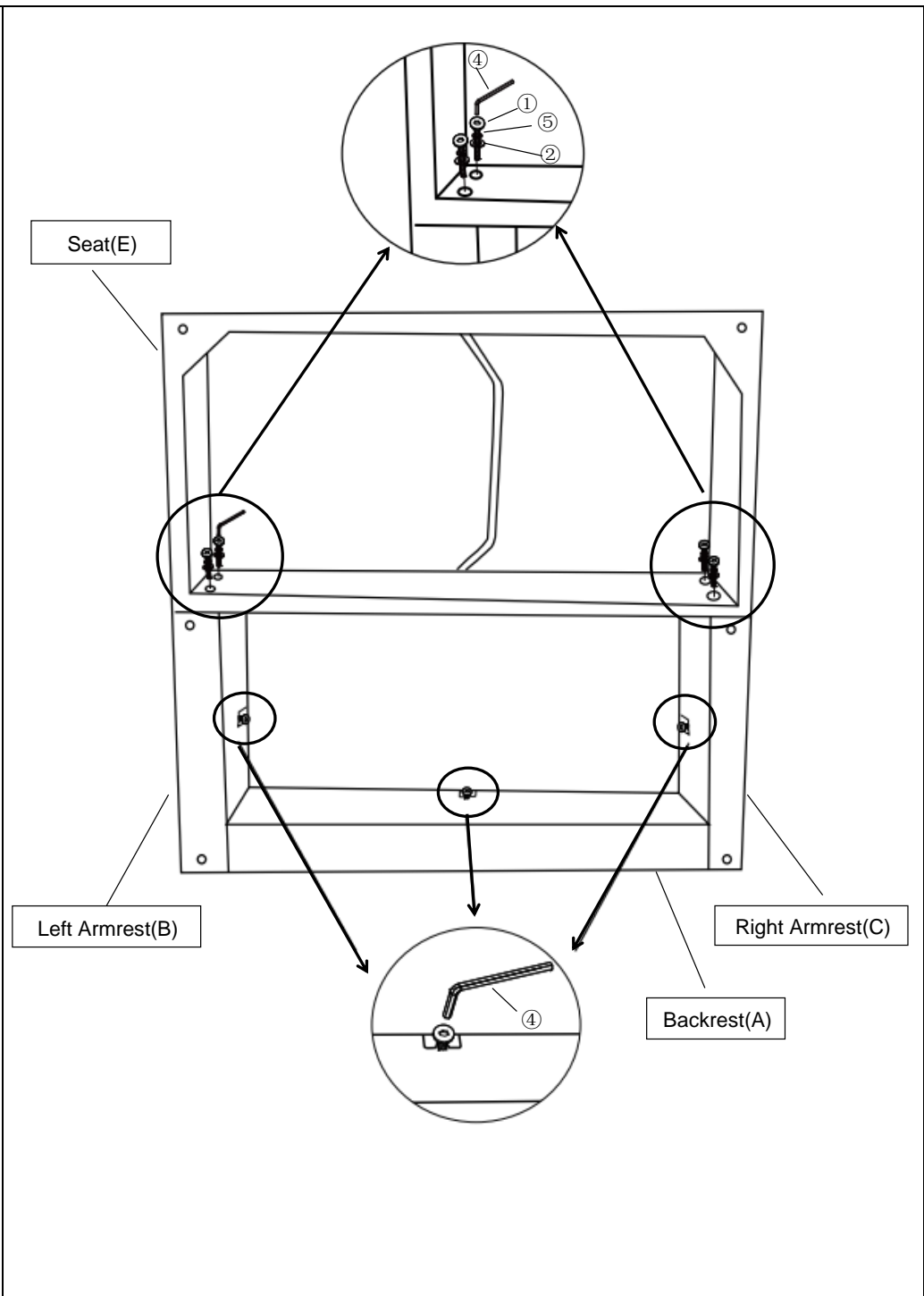

Attach the Seat (E) to Left Armrest(B) and Right Armrest(C) using Bolts(①), Spring Washers(⑤), and Flat Washers(②) with Allen Wrench(④).
Tighten the Bolts on the Left Armrest(B), Right Armrest(C) and the Backrest(A) with the Allen Wrench(④).

Step 8

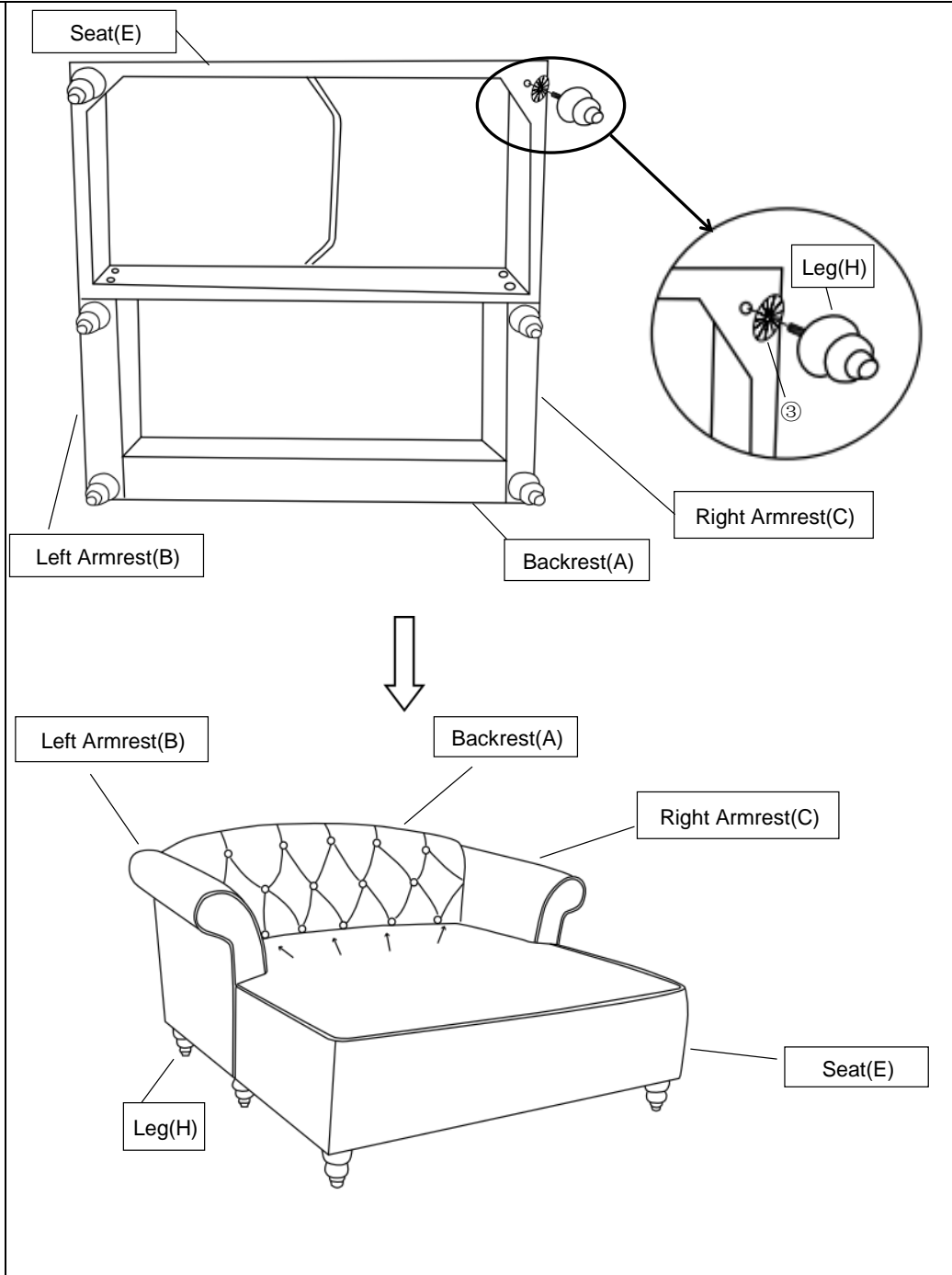

Install the Leg(H) at the bottom of the Loveseat Chaise Lounge by placing one Plastic Washer(③) on the threaded stem.

Then insert threaded stem into the threaded mounting position at the corner of the Chaise.

Tighten by turning the Leg clockwise.

Repeat the same step to install the remaining five Legs.

Lay the Loveseat Chaise Lounge flat and arrange the seat cushion flat.

Note: The use of Gaskets are OPTIONAL and are especially useful to help alleviate slight wobbles. Some Legs may need more than one whilst some legs may not need any.

Step 9

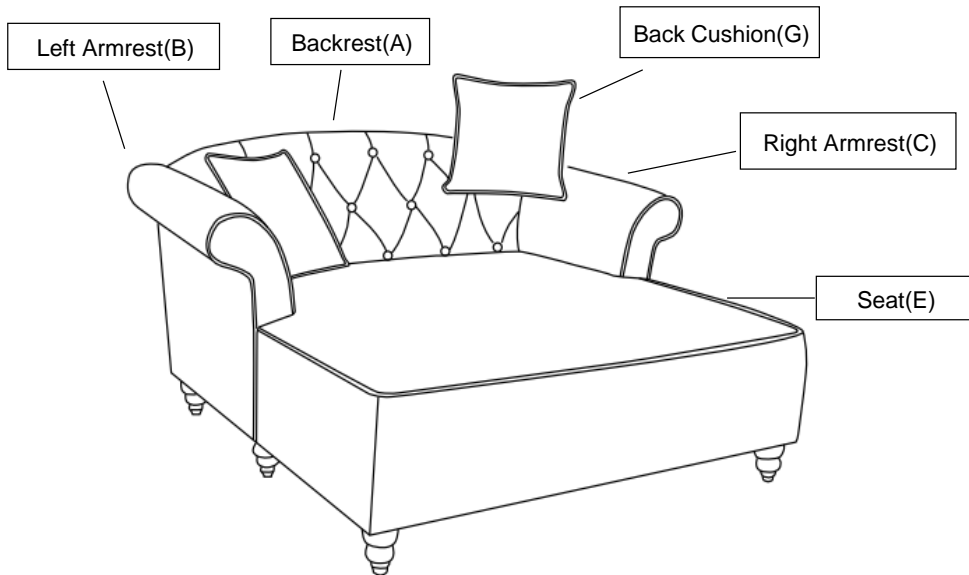

Put the Back Cushion(G) on the Seat(E).

Step 10

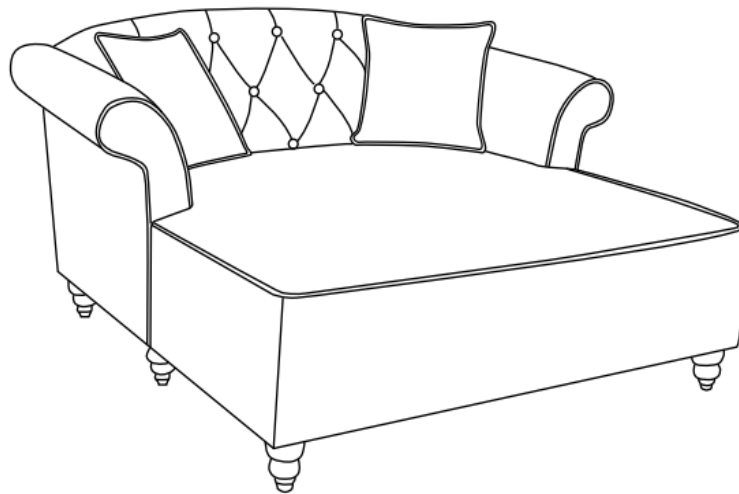

Your Loveseat Chaise Lounge is ready for use.
This Loveseat Chaise Lounge can only be used on a flat, level surface.

Care & Maintenance



- Furniture may scratch floors. We recommend using furniture pads to protect your floors.



- Do not put hot items directly on furniture surface.



- Do not clean furniture with harsh cleansers or polish.



- Do not place furniture under direct sunlight.



- Do not place furniture near heating or cooling vents.



- Do not write on furniture without a padded barrier to protect the surface.



- Do not place furniture outside . For indoor use only.



- Not for commercial use. For residential use only.



- Stains may be removed with mild soap solution and damp cloth.



- Children should not climb or jump on the furniture.



- Dust and pick-up spills using a clean, non-colored, lint-free cloth.