

Assembly Instructions

Caution : You must read this before you proceed

Please look under the seat for hardware packs and legs

Loveseat

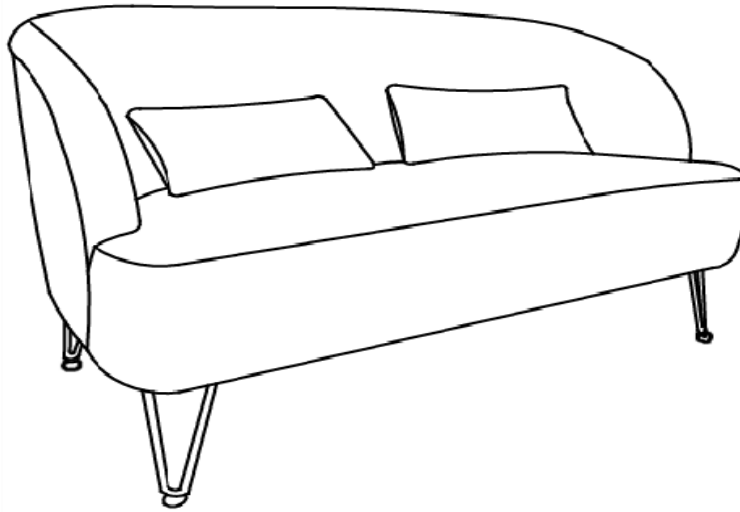

Part List

| Label | Picture | Description | QTY |
|-------|---|---------------------------------|-----|
| A | A line drawing of the loveseat base, showing the curved backrest and the seat cushion without the pillows. | Loveseat Base | 1 |
| B | A line drawing of a single metal leg, which is a tapered, flared shape with a small circular plastic pad at the bottom. | Metal Leg (with Plastic Pad) | 4 |
| C | A line drawing of a rectangular waist pillow with a slightly curved top edge. | Waist Pillow | 2 |

Hardware

| Label | Picture | Description | QTY |
|-------|---|--------------------------------|-----|
| ① |  | Plastic Pad (for Metal Leg) | 4 |
| ② |  | Bolt(M8*30mm) | 13 |
| ③ |  | Allen Wrench | 1 |
| ④ |  | Washer | 13 |
| ⑤ |  | Spring Washer | 13 |

Assembly Preparation

Before Beginning
Assembly:

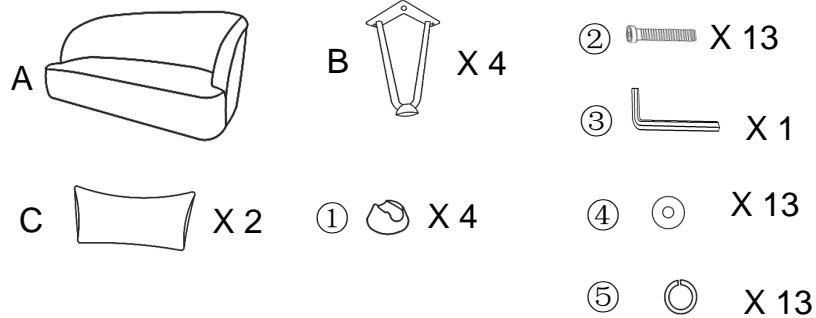

- Read instructions, cover to cover-



- Have 2 adults on hand for assembly-



- Do not assemble on flooring or carpet-



- Assemble on a clean non-marring surface (packing foam)-



- Save all packaging until finished-

Assembly Steps

Overview

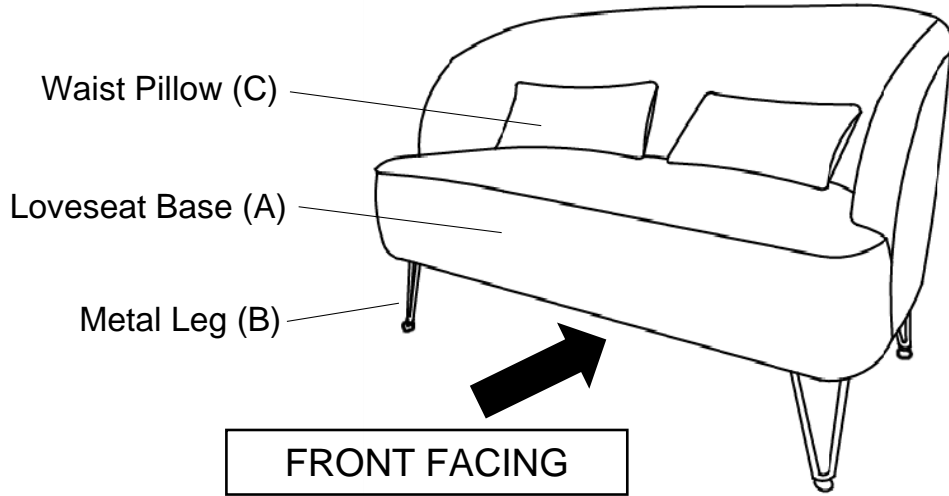

This Loveseat has multiple parts and may require up to 30 minutes to assemble. To give you an overview of the Loveseat parts, the above picture is to help you put the various parts into perspective. Please read through the instructions below to familiarise yourself with the parts and steps before assembly.

Step 1

Leg Pocket

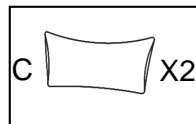
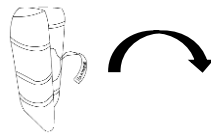
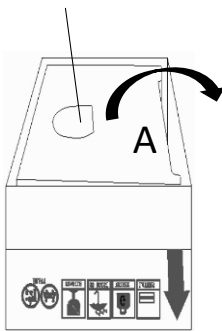

| | | |
|---|--|------|
| B | | X4 |
| ① | | X 4 |
| ② | | X 13 |
| ③ | | X 1 |
| ④ | | X 13 |
| ⑤ | | X 13 |

Open the Leg Pocket and to take out Small Package and Two Waist Pillows(C).
And then to open the small package to take out the Metal Legs(B) and Hardwares.

Step 2

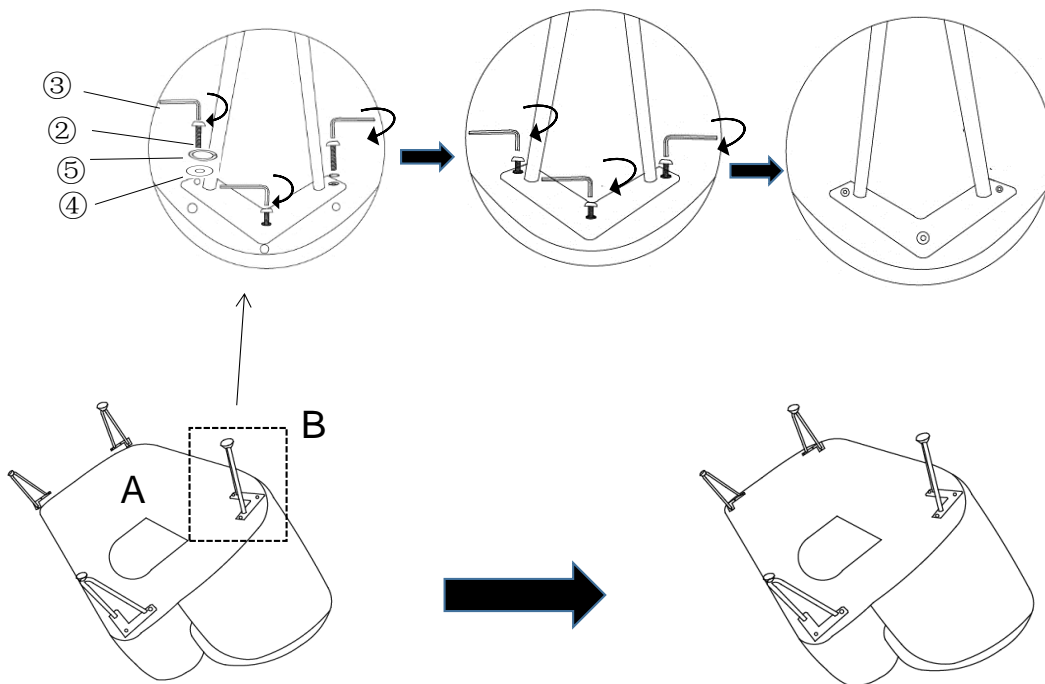

Place Metal Legs(B) onto Loveseat Base(A) and align the three mounting positions as pictured above. Attach Metal Legs(B) to Loveseat Base(A) using Bolts(②), Spring Washers(⑤), and Washers(④) with Allen Wrench(③).

Repeat the same process to attach other Metal Legs(B).

Tighten the Bolts fully in a sequential manner.

Step 3

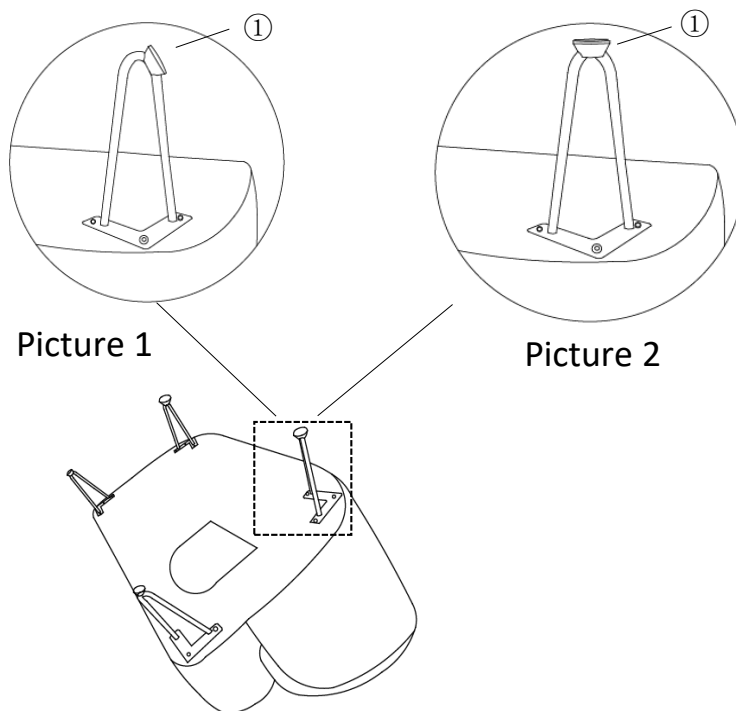

After the Metal Legs(B) are installed, please ensure all the Plastic Pads(①) are in the right position as shown in Picture 2.

Step 4

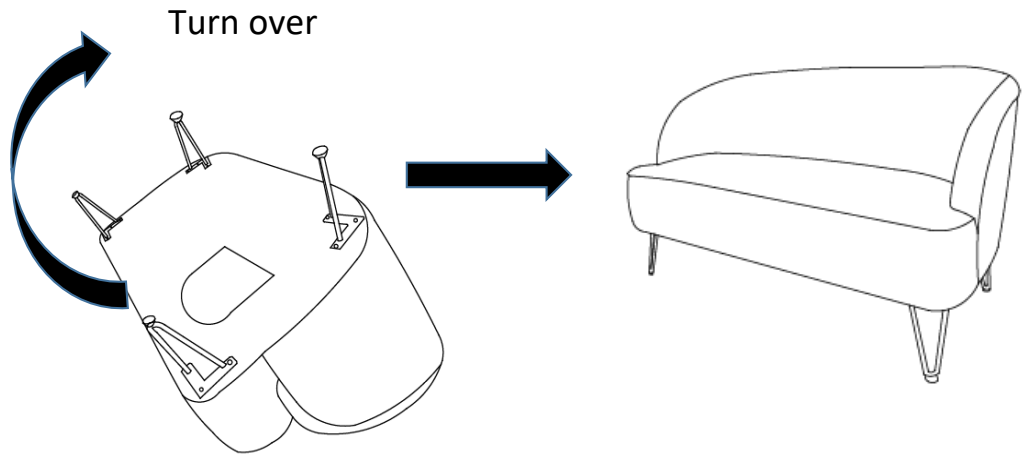

With help of an adult partner, stand the Loveseat up.

Step 5

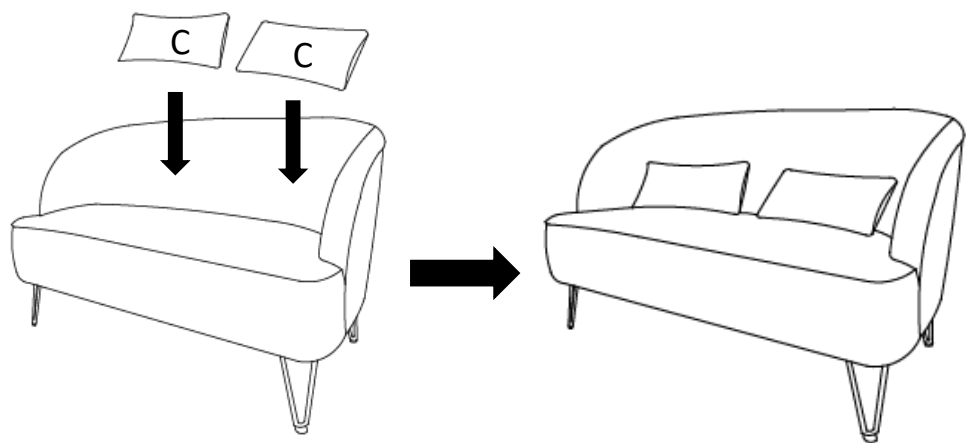





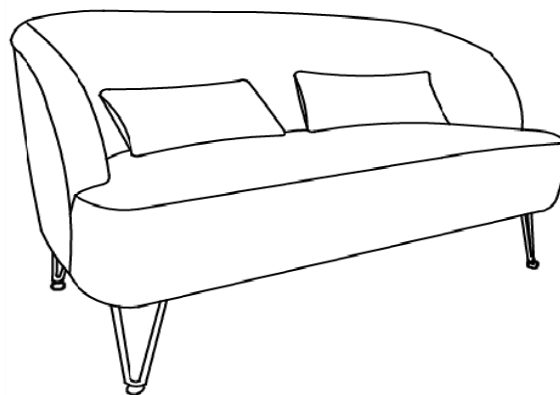

















Put the two Waist Pillows(C) onto the Loveseat

Step 6



Your Loveseat is ready for use.
This Loveseat can only be used on a flat, level surface.

Care & Maintenance

| | |
|---|---|
|   | <ul style="list-style-type: none"> Furniture may scratch floors. We recommend using furniture pads to protect your floors. |
|   | <ul style="list-style-type: none"> Do not put hot items directly on furniture surface. |
|   | <ul style="list-style-type: none"> Do not clean furniture with harsh cleansers or polish. |
|   | <ul style="list-style-type: none"> Do not place furniture under direct sunlight. |
|   | <ul style="list-style-type: none"> Do not place furniture near heating or cooling vents. |
|   | <ul style="list-style-type: none"> Do not write on furniture without a padded barrier to protect the surface. |
|   | <ul style="list-style-type: none"> Do not place furniture outside. For indoor use only. |
|   | <ul style="list-style-type: none"> Not for commercial use. For residential use only. |
|   | <ul style="list-style-type: none"> Stains may be removed with mild soap solution and damp cloth. |
|   | <ul style="list-style-type: none"> Children should not climb or jump on the furniture. |
|   | <ul style="list-style-type: none"> Dust and pick-up spills using a clean, non-colored, lint-free cloth. |

Questions & Answers about Proposition 65

• What is Proposition 65?

Proposition 65 requires businesses to provide warnings to Californians about significant exposures to chemicals that cause cancer, birth defects or other reproductive harm. These chemicals can be in the products that Californians purchase, in their homes or workplaces, or that are released into the environment. By requiring that this information be provided, Proposition 65 enables Californians to make informed decisions about their exposures to these chemicals.

Proposition 65 also prohibits California businesses from knowingly discharging significant amounts of listed chemicals into sources of drinking water.

Proposition 65 requires California to publish a list of chemicals known to cause cancer, birth defects or other reproductive harm. This list, which must be updated at least once a year, has grown to include approximately 900 chemicals since it was first published in 1987.

• What types of chemicals are on the Proposition 65 list?

The list contains a wide range of naturally occurring and synthetic chemicals that include additives or ingredients in pesticides, common household products, food, drugs, dyes, or solvents. Listed chemicals may also be used in manufacturing and construction, or they may be byproducts of chemical processes, such as motor vehicle exhaust.

• What does a warning mean?

If a warning is placed on a product label or posted or distributed at a workplace, a business, or in rental housing, the business issuing the warning is aware or believes that it is exposing individuals to one or more listed chemicals.

By law, a warning must be given for listed chemicals unless the exposure is low enough to pose no significant risk of cancer or is significantly below levels observed to cause birth defects or other reproductive harm.

• Where can I get more information on Proposition 65?

If you have specific questions on the administration or implementation of Proposition 65, you can contact OEHHA's Proposition 65 program at P65.Questions@oehha.ca.gov, or by phone at (916) 445-6900.