

Assembly Instructions

A

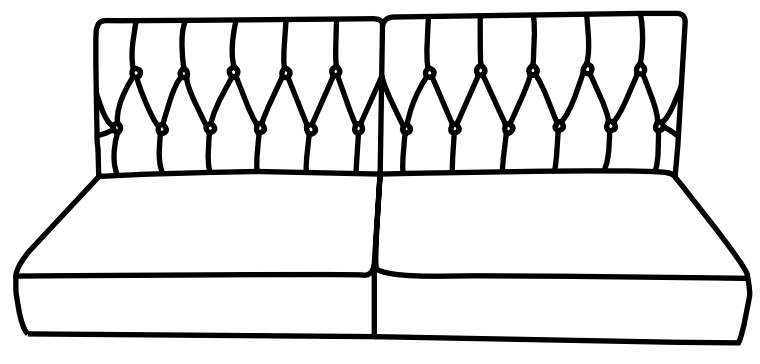

Sofa*1

B

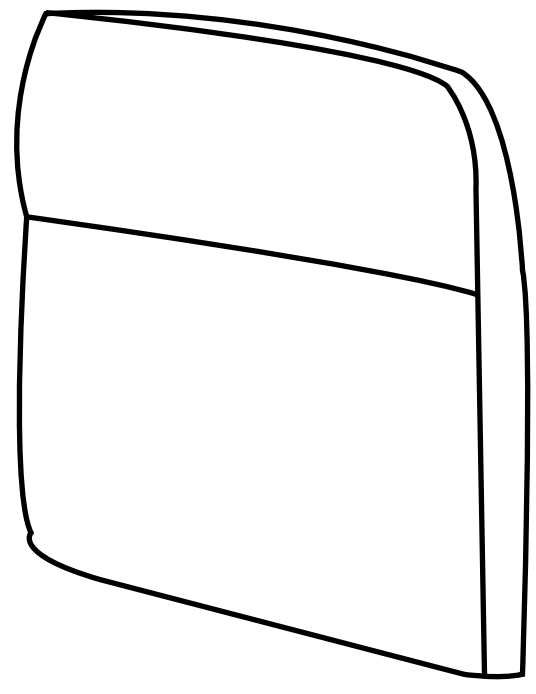

Arm*2

C

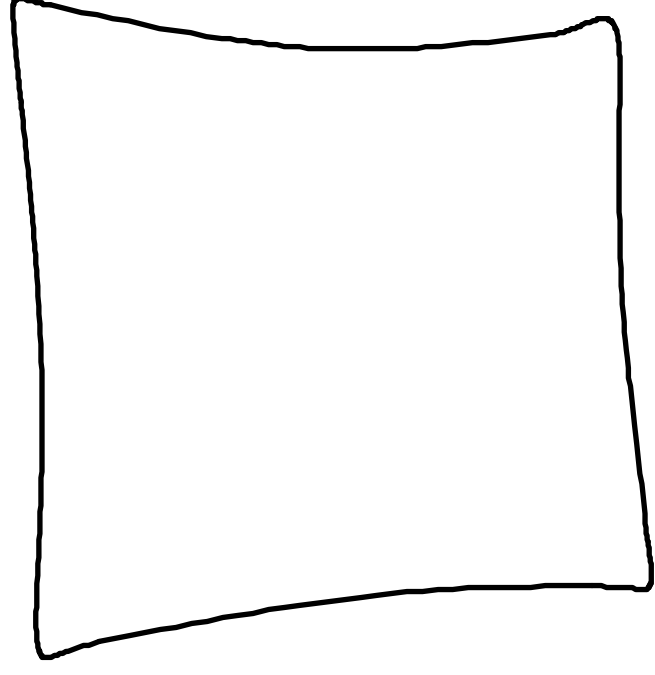

Pillow *1

D

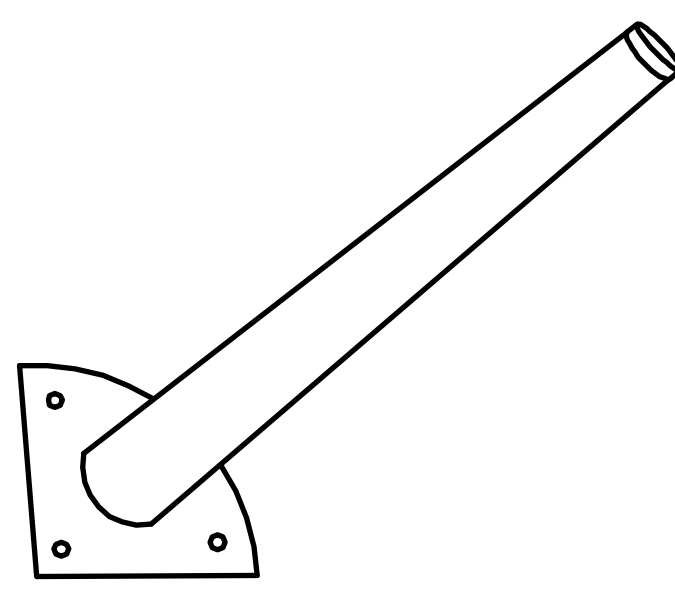

Metal Leg *4

E

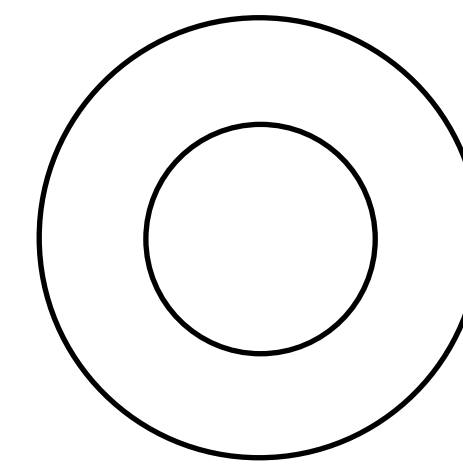

Shim*12

F

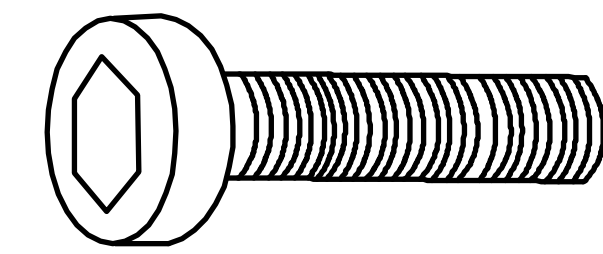

Screw *12

G



Screw *1

①

Turn the back up

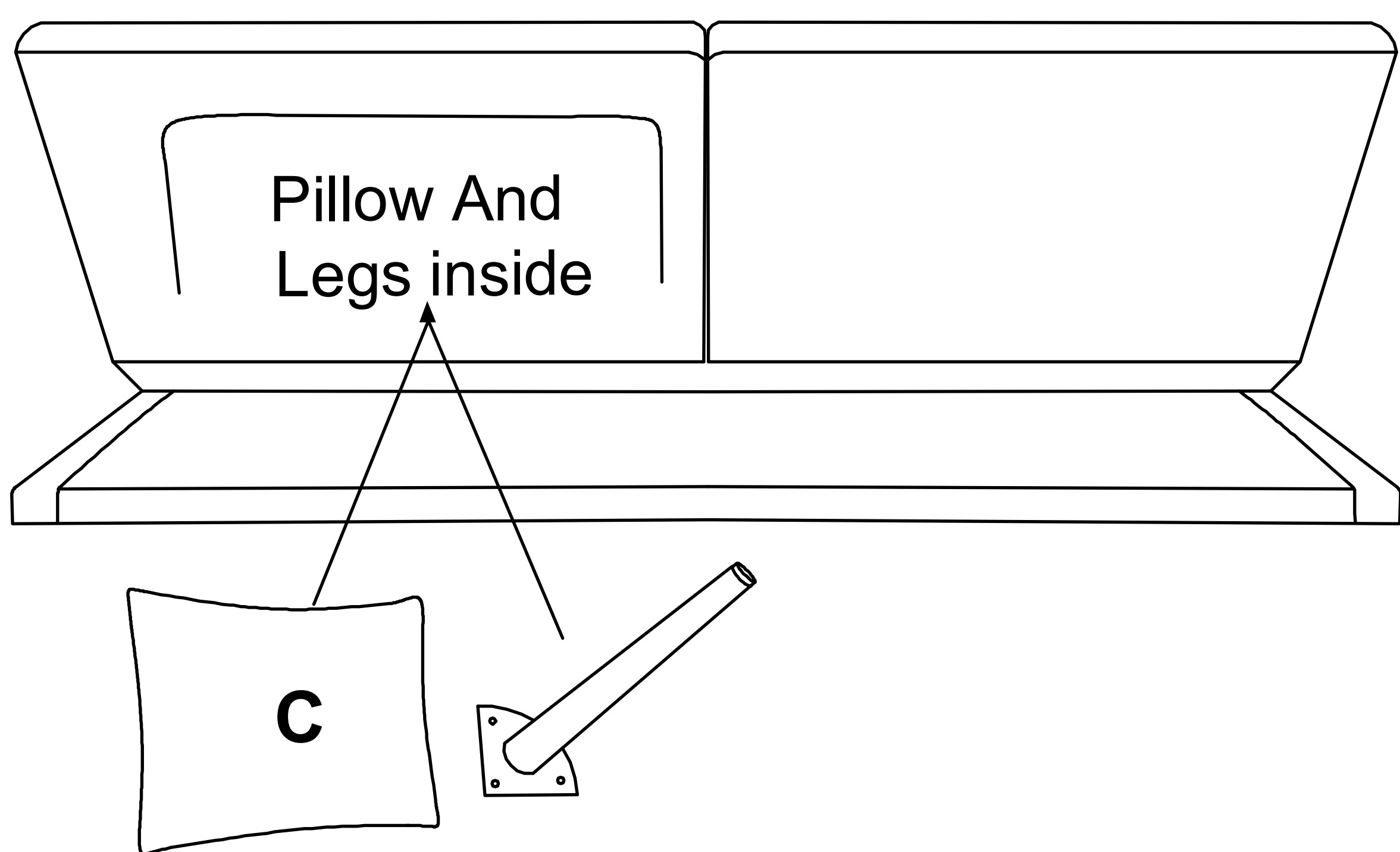

②

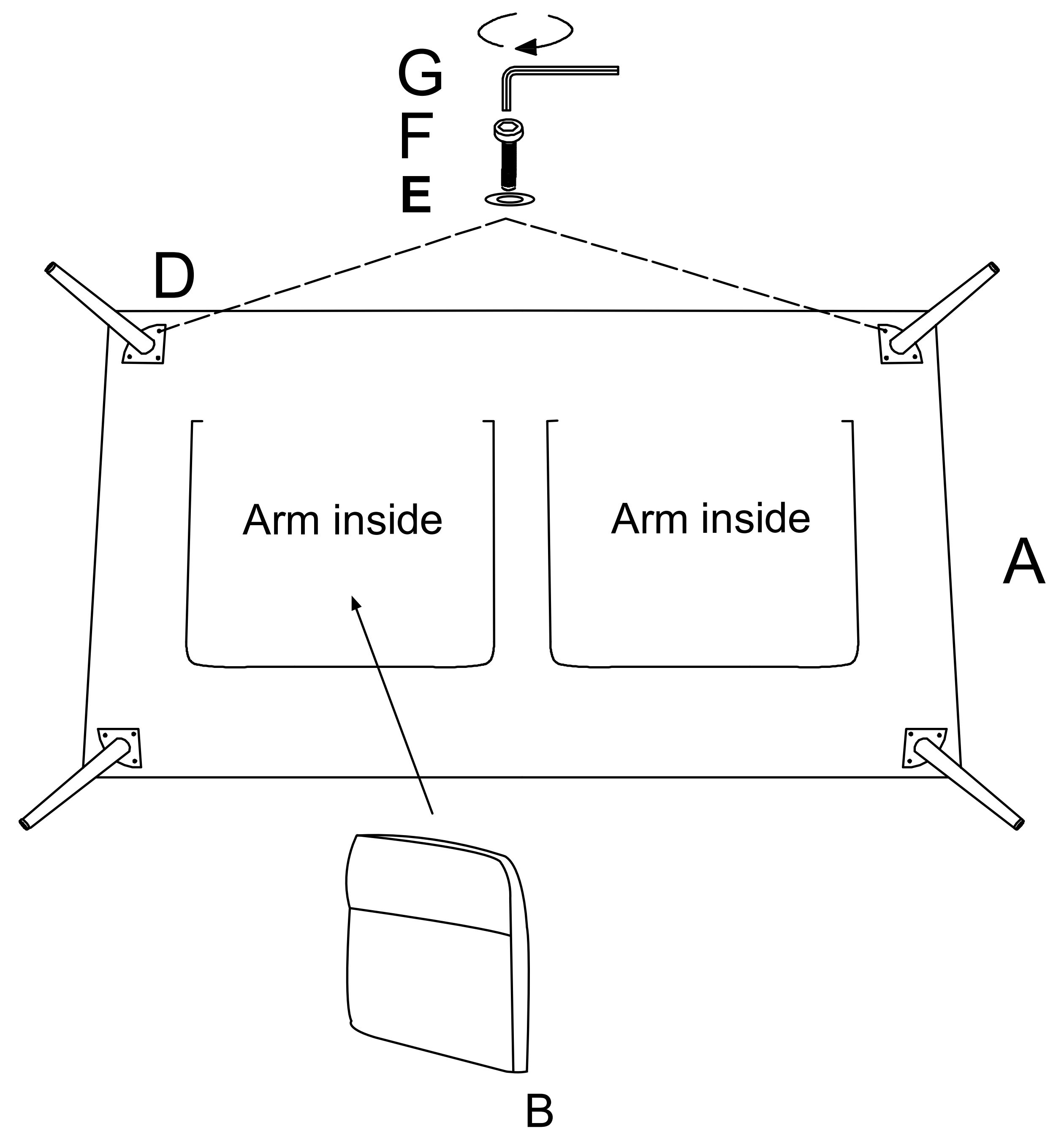

③

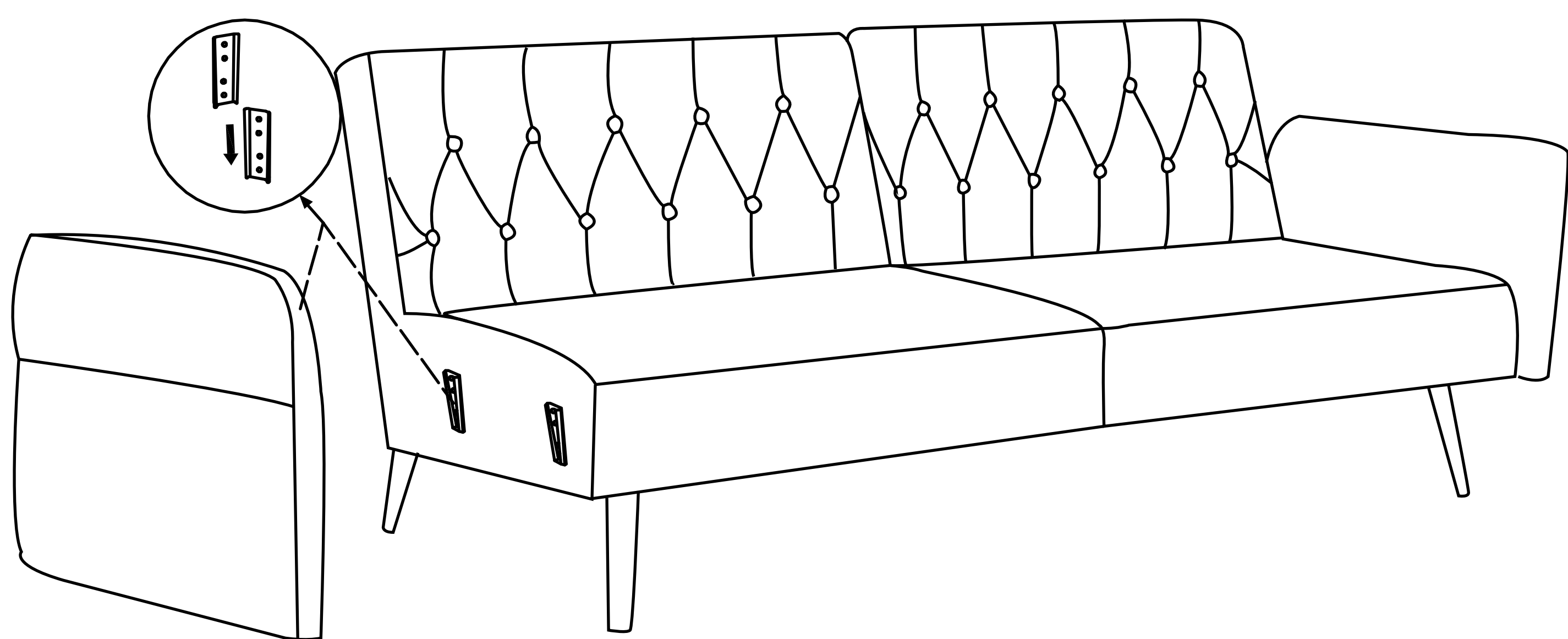

④

