

# ASSEMBLY INSTRUCTION

## Hugo Sofa Bed

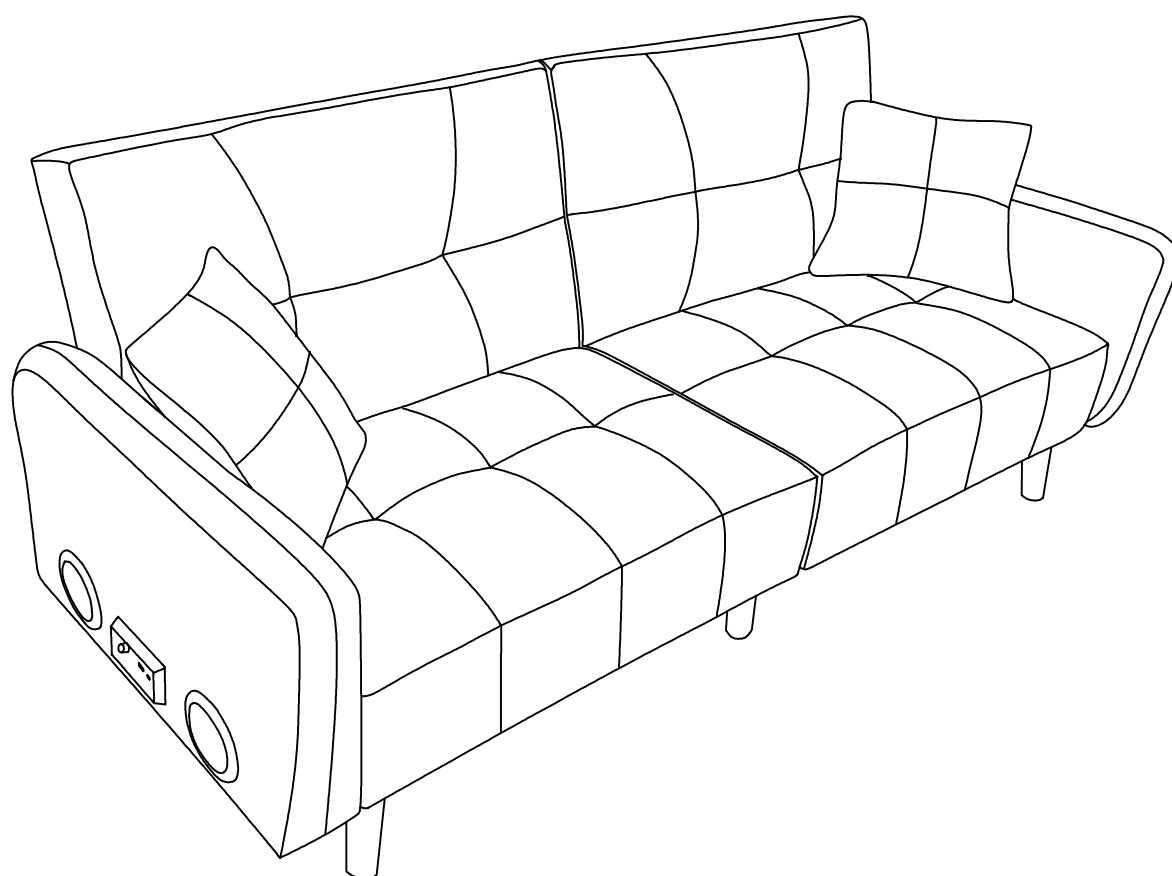

# PART LIST



A 4PCS



B 2PCS



C 4PCS

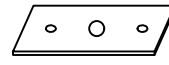

D 2PCS

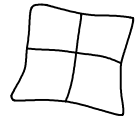

E 2PCS

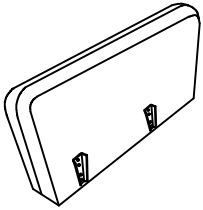

F 1PCS

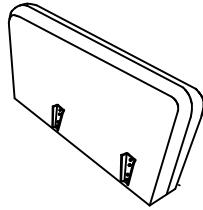

G 1PCS

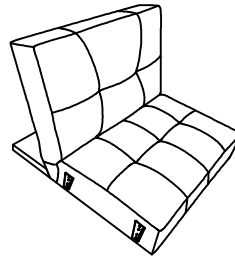

H 1PCS

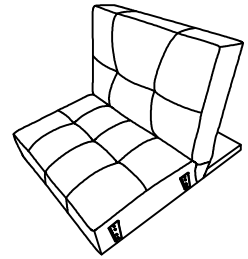

I 1PCS

# ASSEMBLY STEPS

## STEP 1

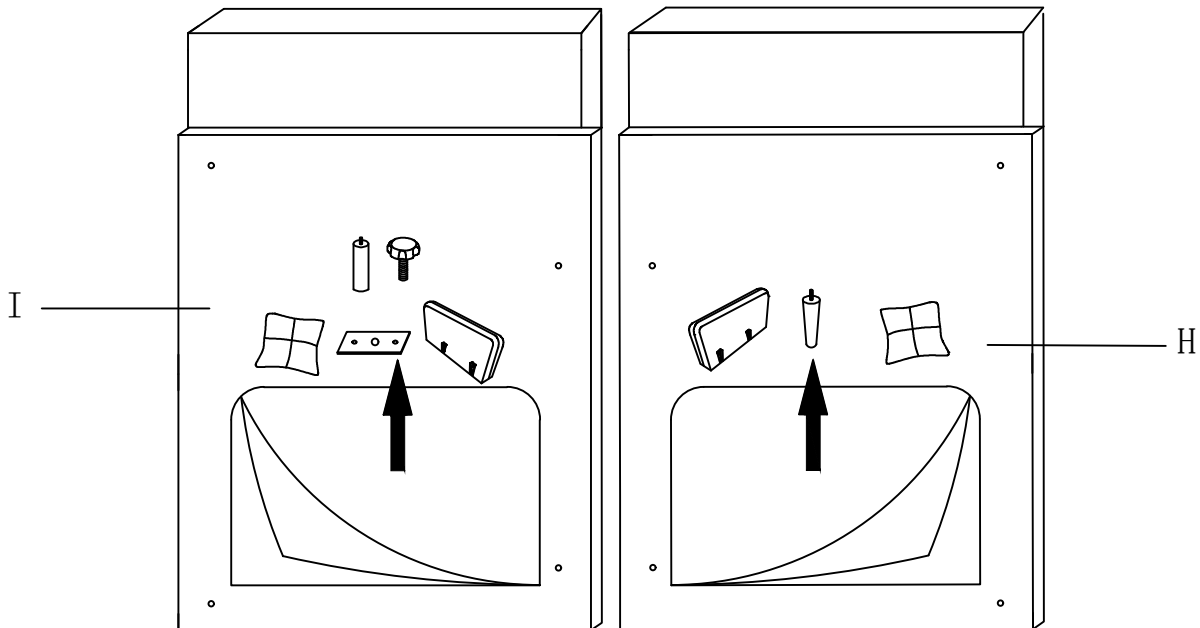

Remove the accessories from the bottom of the sofa

## STEP 2

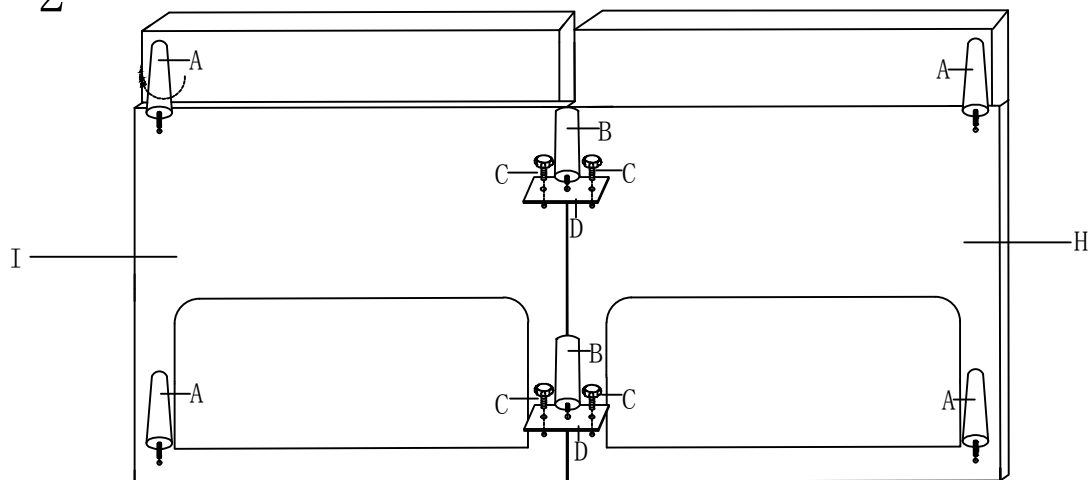

Screw the foot of the sofa onto the sofa

## STEP 3

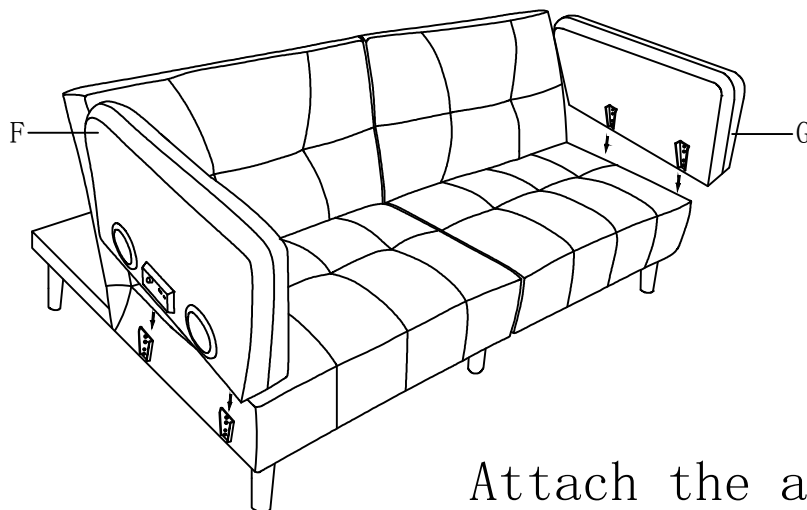

Attach the armrests to the sofa

## STEP 4

