

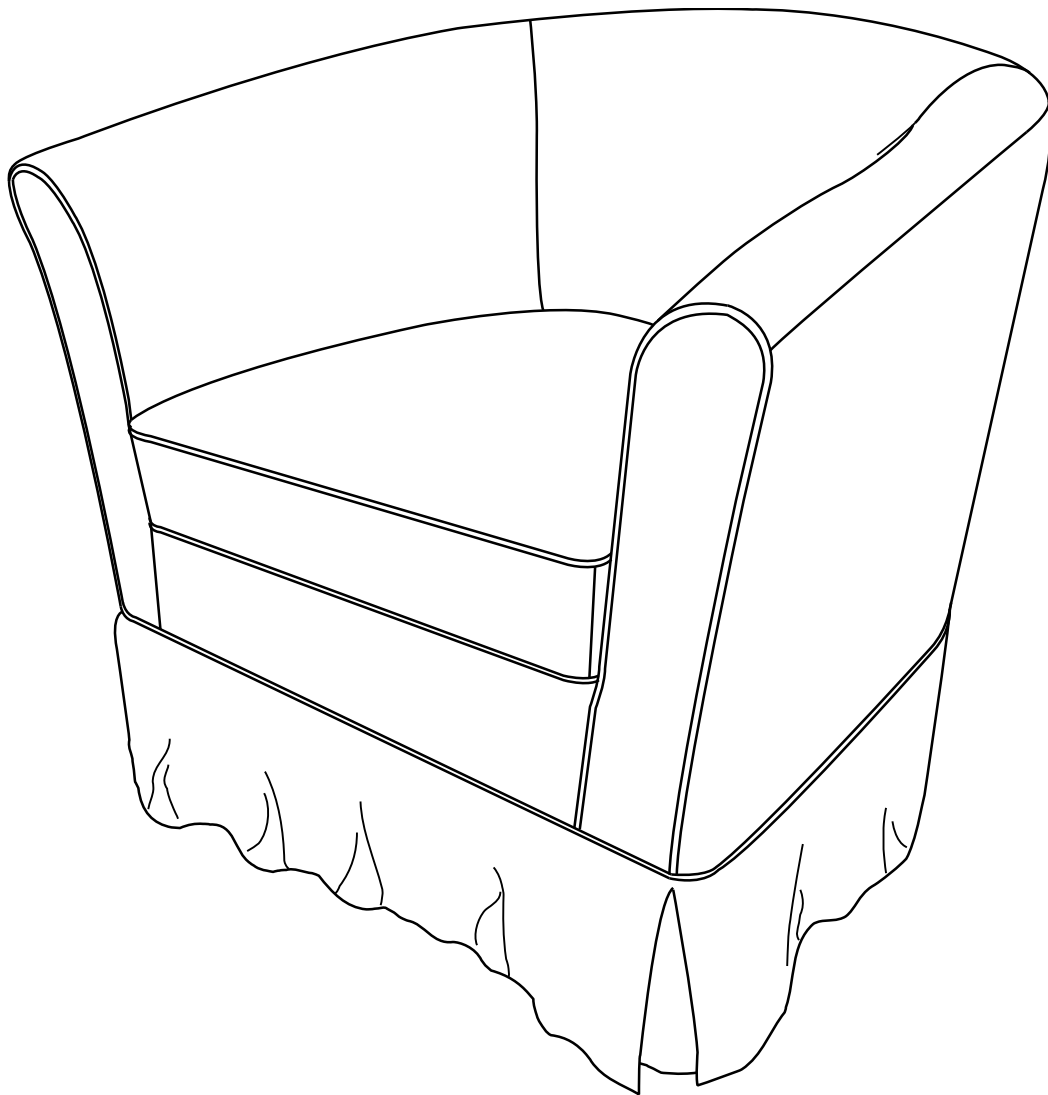

Assembly Instructions

Caution : You must read this before you proceed



Swivel Club Chair

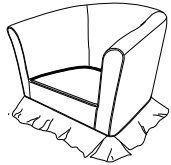

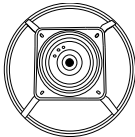
Parts List

Label	Picture	Description	QTY
A		Chair	1
B		Seat Cushion	1
C		Swivel	1

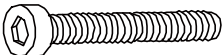
Hardware

Label	Picture	Description	QTY
①		Allen Key	1
②		Bolt (M6X40mm)	5
③		Washer	5

Assembly Preparation

Before Beginning Assembly:

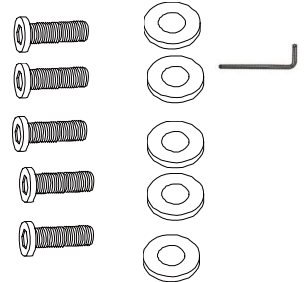
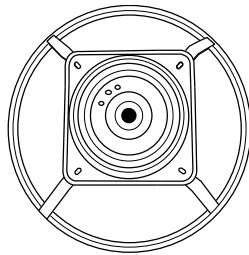
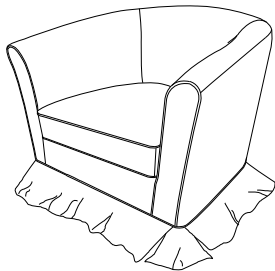

- Read instructions, cover to cover-



- Have 2 adults on hand for assembly-



- Do not assemble on flooring or carpet-



- Assemble on a clean non-marring surface (packing foam)-



- Save all packaging until finished-

Assembly Steps

Overview

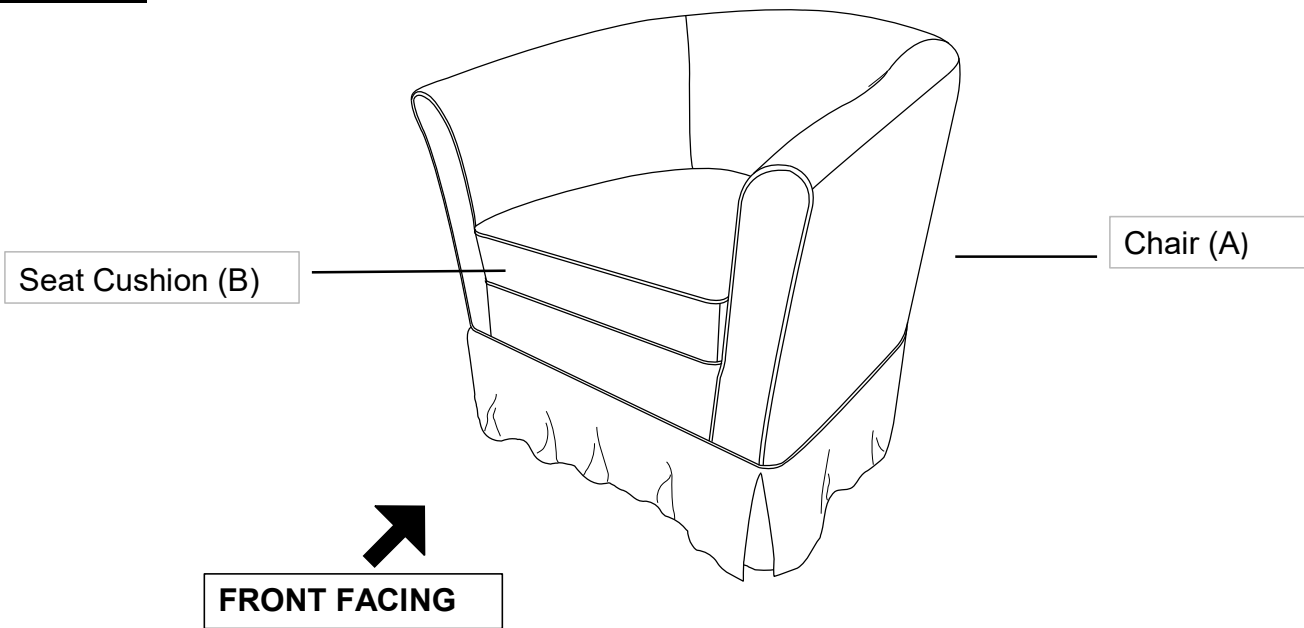

This Swivel Club Chair has multiple parts and may require up to 30 minutes to assemble. To give you an overview of the Swivel Club Chair parts, the above picture is to help you put the various Swivel Club Chair parts into perspective. Please read through the instructions to familiarise yourself with the parts and steps before assembly.

Step 1

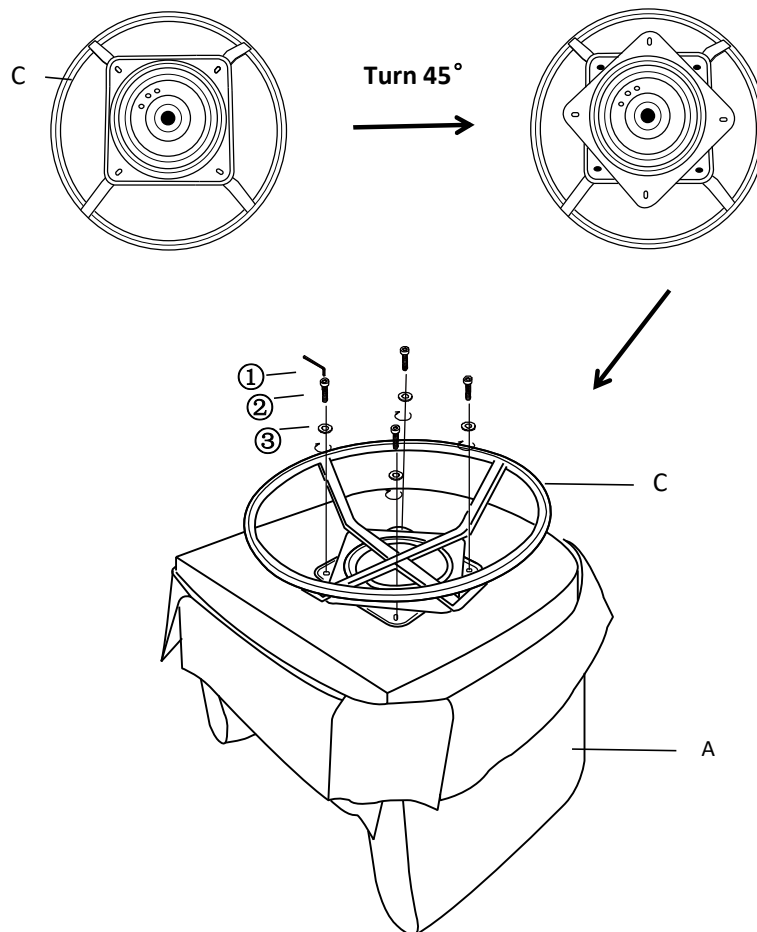

Turn the swivel by 45° first until can see the four mounting positions.
Place the Chair(A) face down onto a flat, clean, non-marring surface.
Align the Chair(A) to the notch of the Swivel(C) with your partner.
Attach the Chair(A) and the Swivel(C) using Bolts(②) and Washer Ring(③) with Allen Key(①).

Step 2

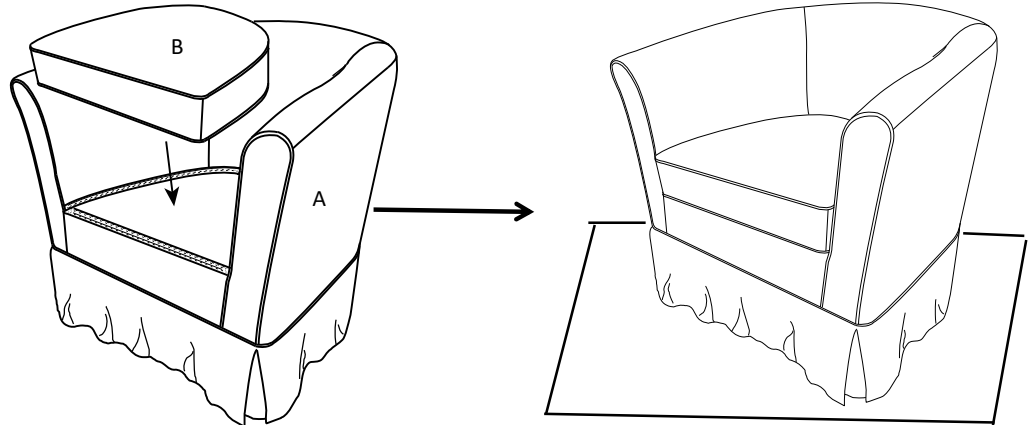

Test for stability

Position the Chair(A) right side up as shown above.
Put Seat Cushion(B) on Chair(A). It can stick Seat Cushion(B) on Chair(A) with magic tape (Black Color).

Position Chair right side up and test for stability.

Note: The use of Washers(③) are OPTIONAL and are especially useful to help alleviate slight wobbles. Some Bolts may need more than one Washer(③) whilst some Bolts may not need any Washers(③).

Add or remove Washer Rings where needed to achieve stability.



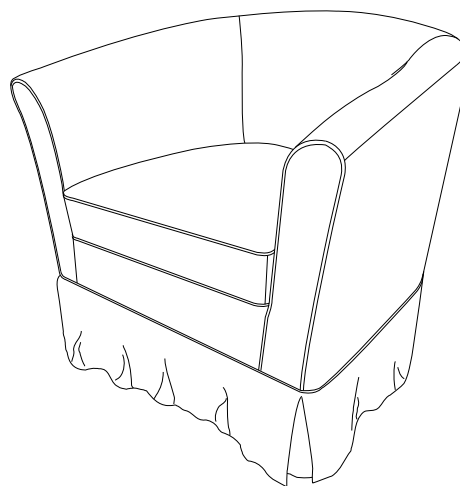







Step 3



Your Swivel Club Chair is ready for use.

This Swivel Club Chair can only be used on a flat, level surface.

Care & Maintenance

- ✓  • Furniture may scratch floors. We recommend using furniture pads to protect your floors.
 - ⊘  • Do not put hot items directly on furniture surface.
 - ⊘  • Do not clean furniture with harsh cleansers or polish.
 - ⊘  • Do not place furniture under direct sunlight.
 - ⊘  • Do not place furniture near heating or cooling vents.
 - ⊘  • Do not write on furniture without a padded barrier to protect the surface.
 - ⊘  • Do not place furniture outside . For indoor use only.
 - ⊘  • Not for commercial use. For residential use only.
 - ⊘  • Stains may be removed with mild soap solution and damp cloth.
 - ⊘  • Children should not climb or jump on the furniture.
-
- ✓  • Dust and pick-up spills using a clean, non-colored, lint-free cloth.