

# ASSEMBLY INSTRUCTION

**!** This instruction booklet contains important safety information. please read and keep for future reference.

This sofa collection work as modular sofa function , it can be an accent chair, 2 seater sofas, 3 seater sofas, L shape sofas, corner sofa, sofa sets with buying different sections of the sofas and combine them together.

You can decide to buy more components according to your living room size.

Below are some guidelines for you how you can do mix and match.

## Accent chair



## L shape sofas

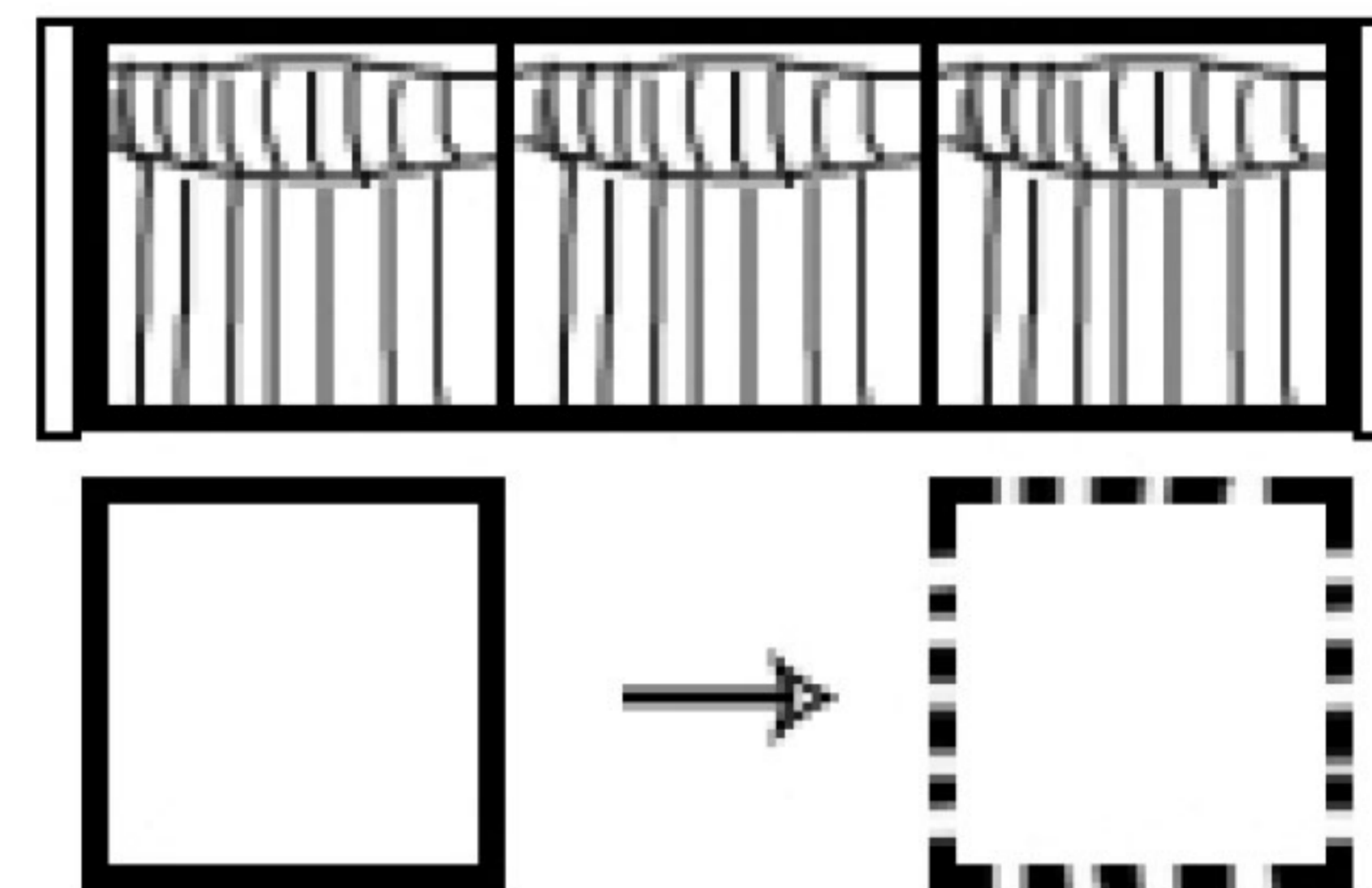

## Accent chair + ottoman

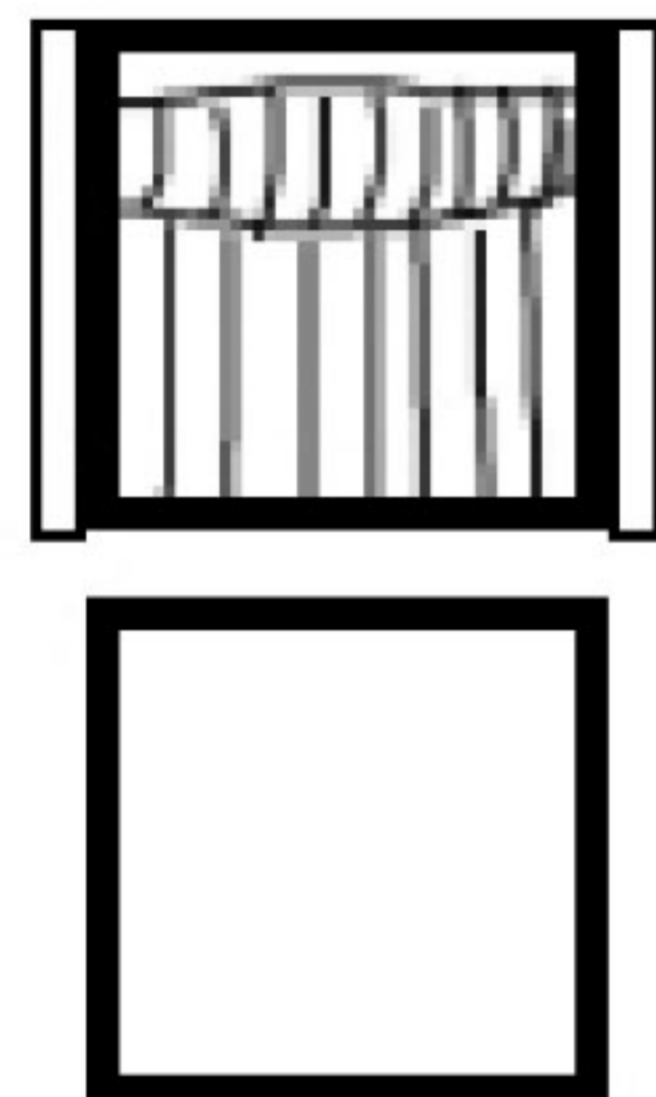

## Space saving sofa sets

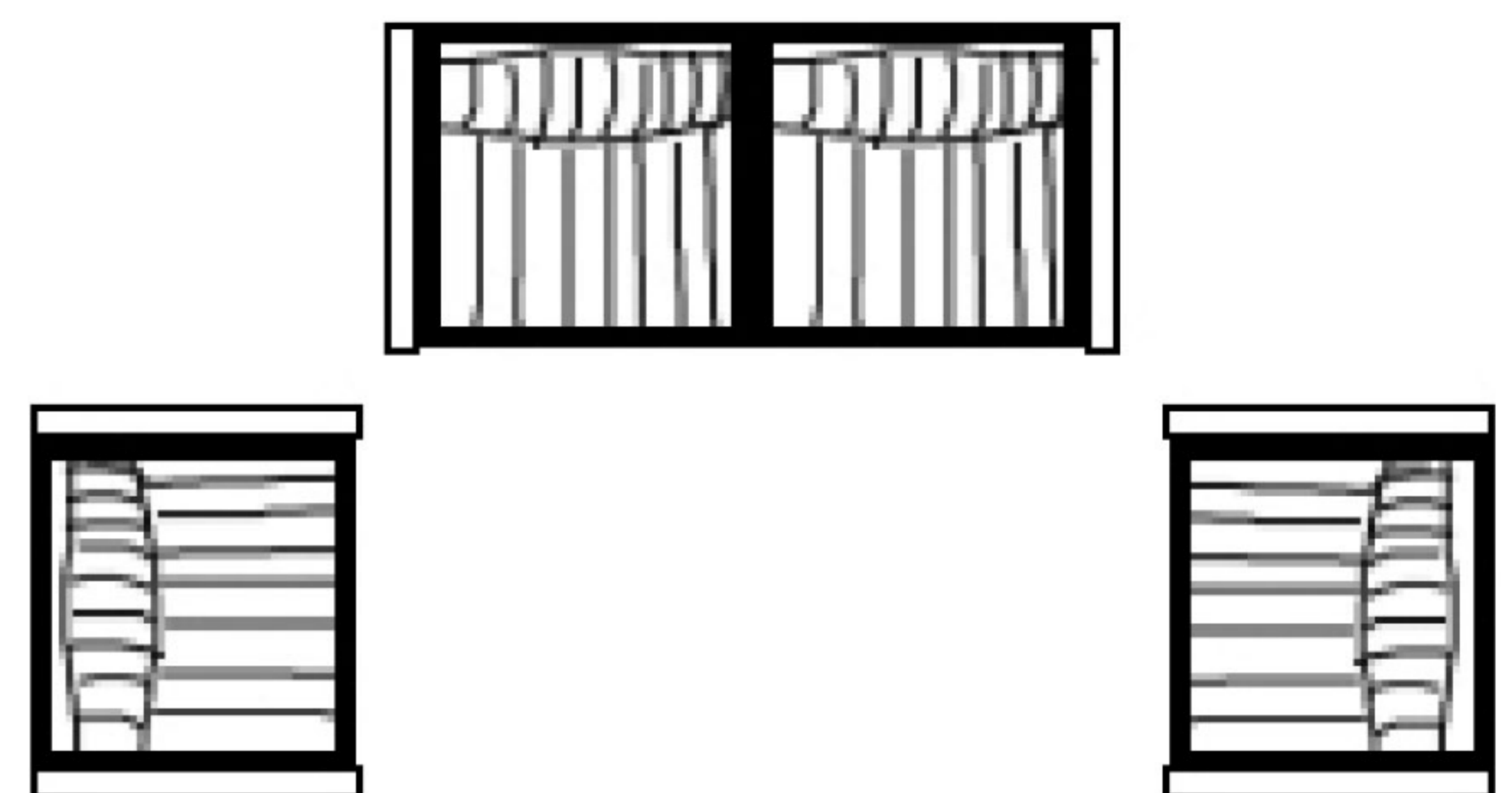

## 2 seater sofa







## Sofa sets



## 3 seater sofa

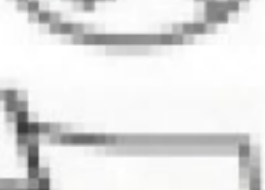







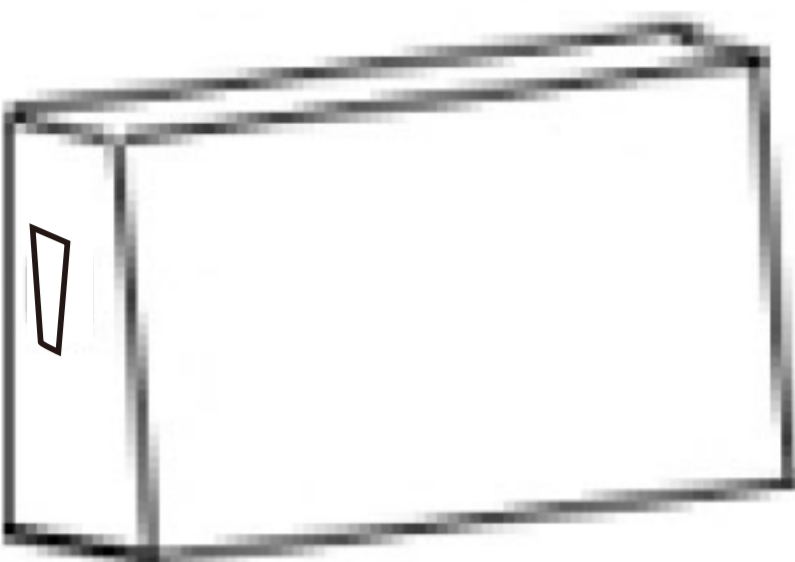

-  • Read instructions, cover to cover
-  • Have 2 adults on hand for assembly
-  • Do not assemble on flooring or carpet
-  • Assemble on a clean non-marring surface (packing foam)
-  • Save all packaging until finished

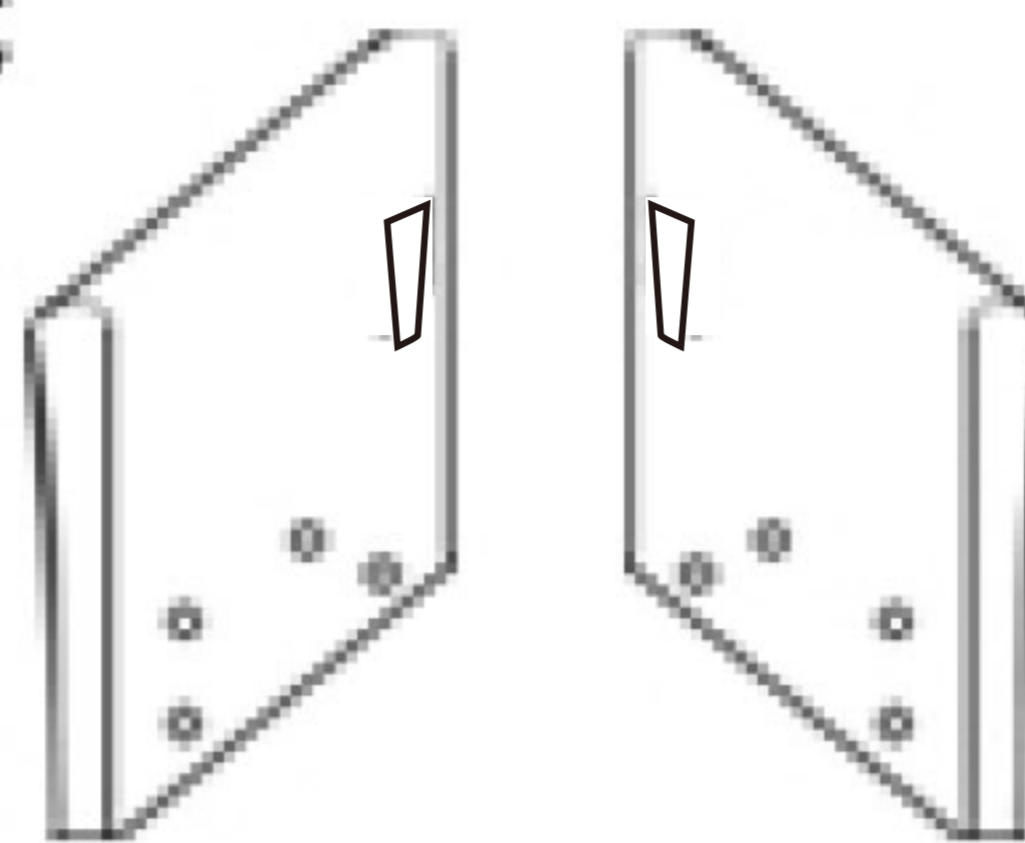
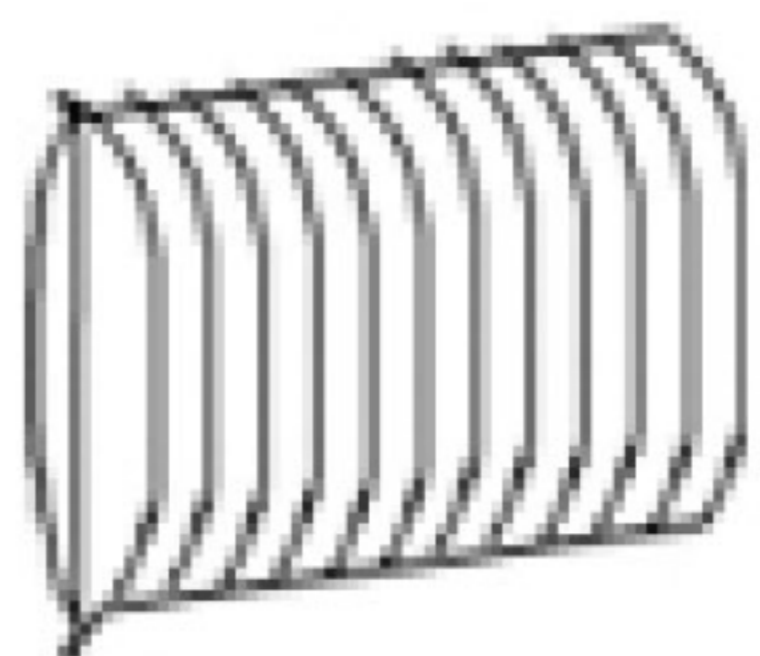
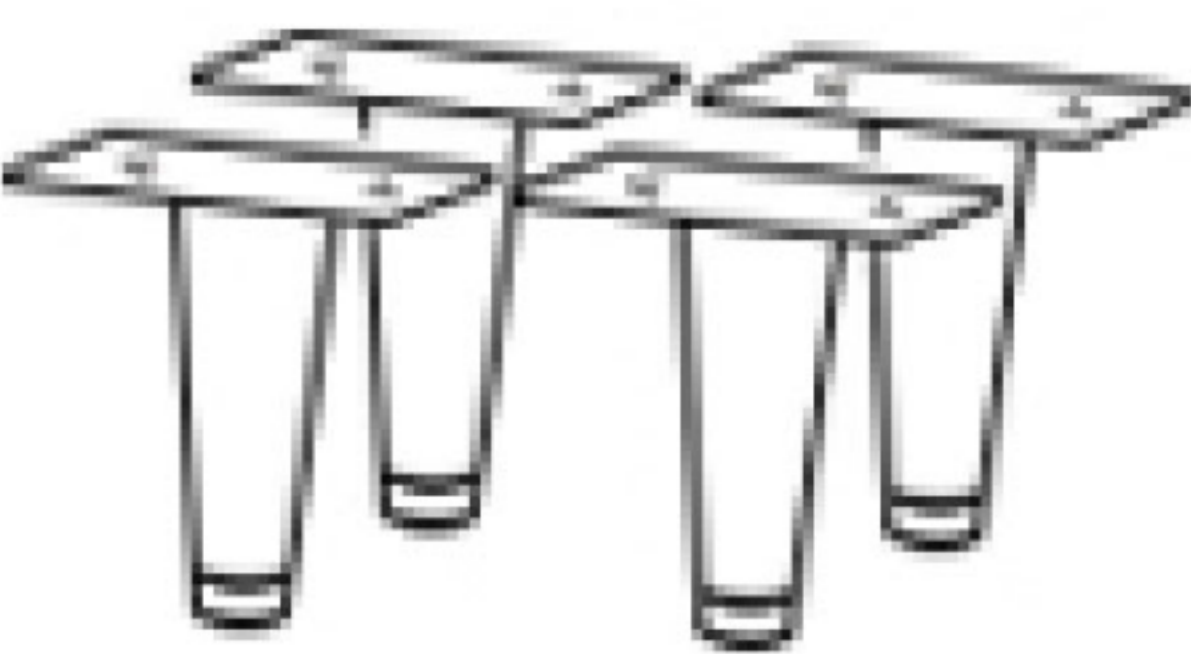

**IF YOU BUY A SINGLE SOFA**  
please follow below assembly instruction

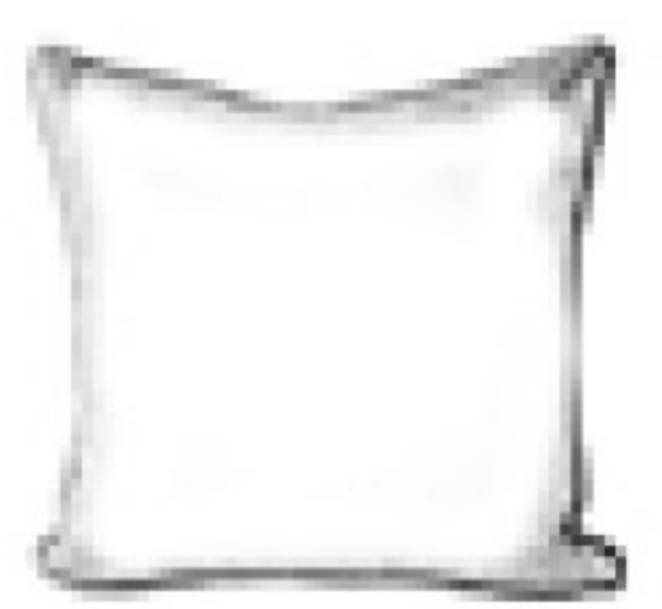
**Parts included**

<p><b>A</b></p>  <p>Backrest 1 pc</p>	<p><b>B</b></p>  <p>Seat 1 pc</p>	<p><b>C</b></p>  <p>Arms 2 pcs</p>	<p><b>D</b></p>  <p>Back pillow 1 pc</p>	<p><b>E - 1</b></p>  <p>Tapered leg 4 pcs</p>
<p><b>F</b></p>  <p>Bolt M8 * 75mm * 10 pcs</p>	<p><b>N</b></p>  <p>Bolt M8*30mm*8 pcs</p>	<p><b>H</b></p>  <p>Allen key 1 pc</p>	<p><b>G</b></p>  <p>Washer 18 pcs</p>	<p><b>Z</b></p>  <p>Toss Pillow 1 pc</p>
			<p><b>Y</b></p>  <p>Spring ring 18 pcs</p>	

**Assembly steps**

**Step1** Assemble the backrest with seat.

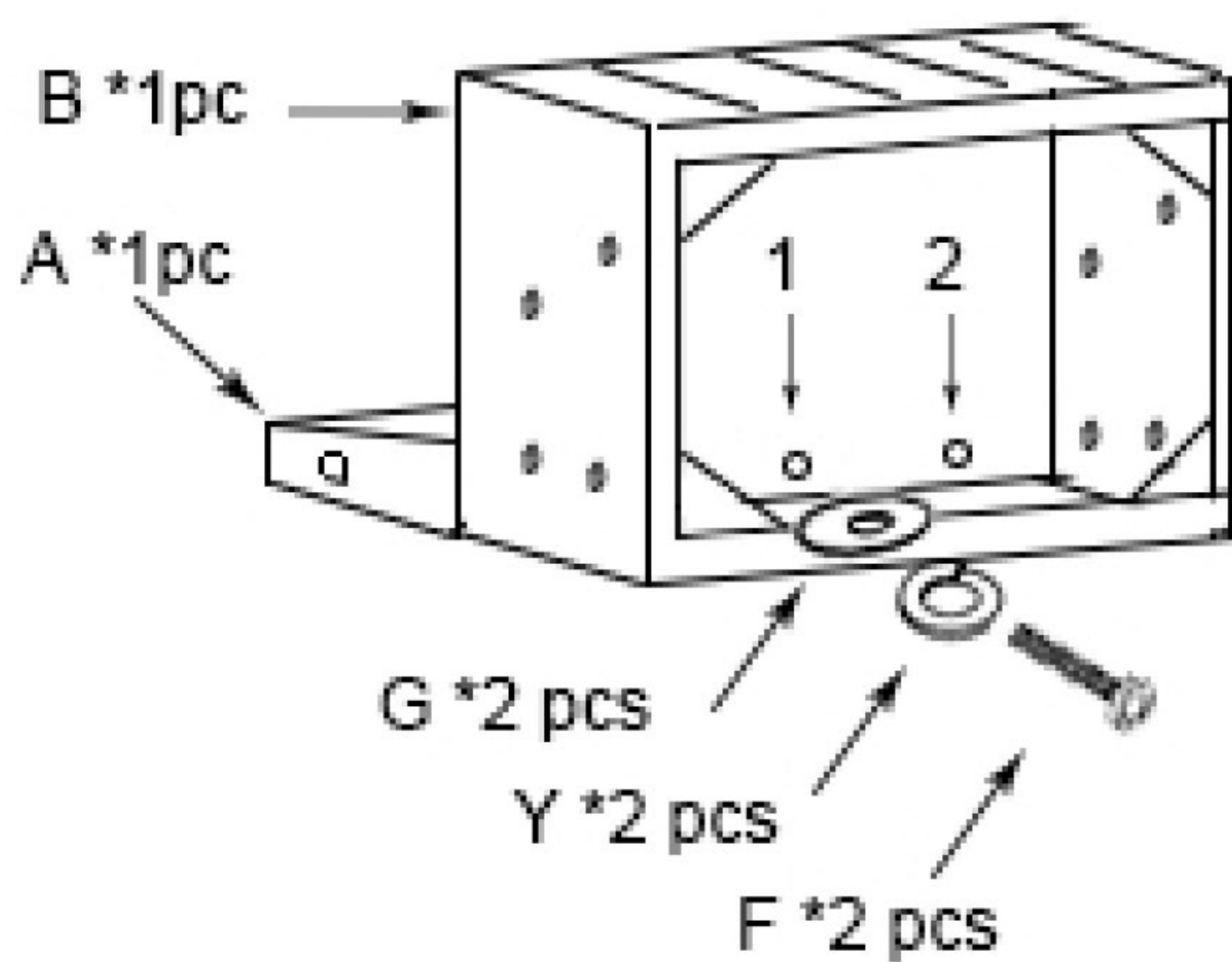

**Step2** Secure the hook on arm with the hook on backrest, tighten the arm to seat apron with screws and washers;do it the same for the other arm.

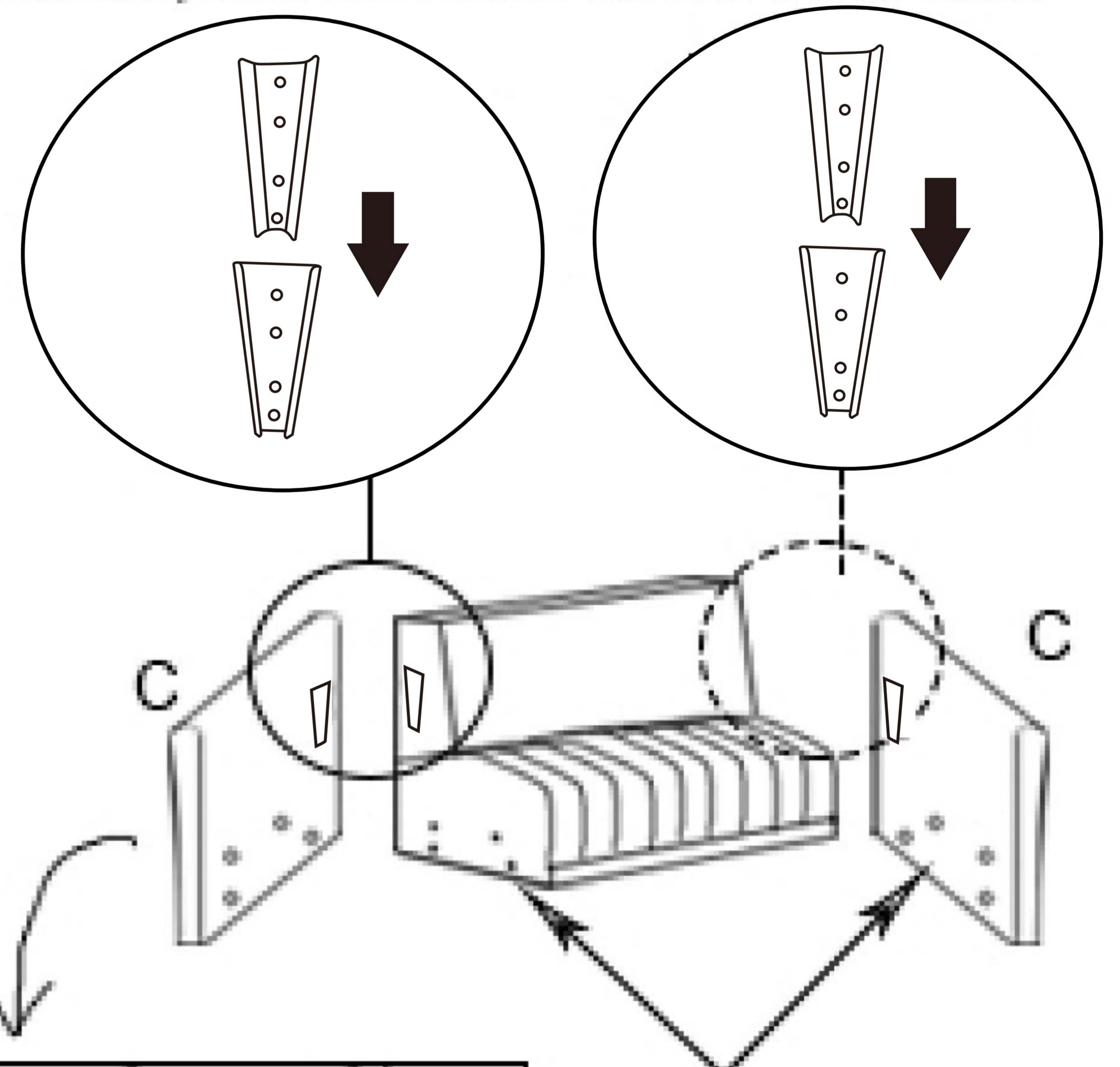

**Step3** Assemble the legs to the bottom of both arms.

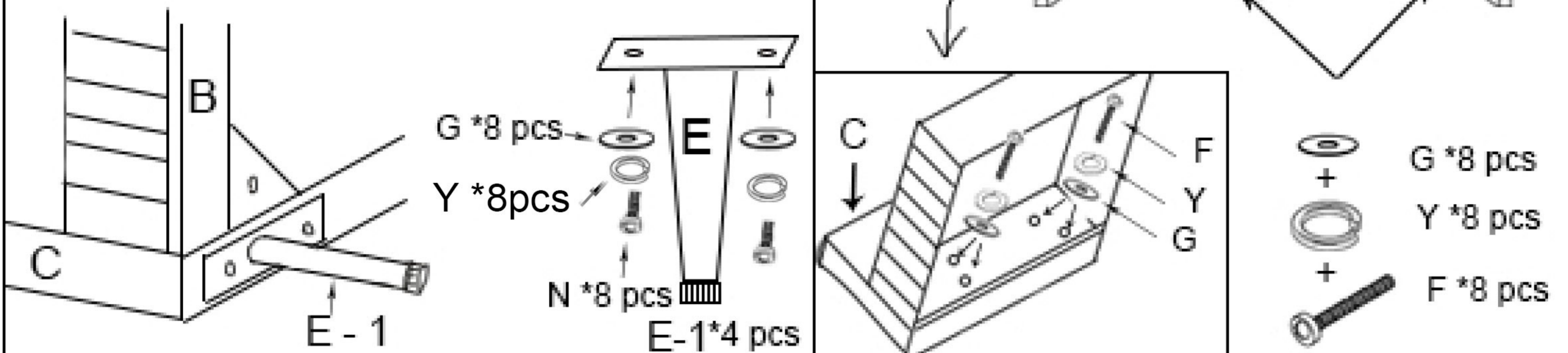

**Step4** Put the pillow on front of the back panel



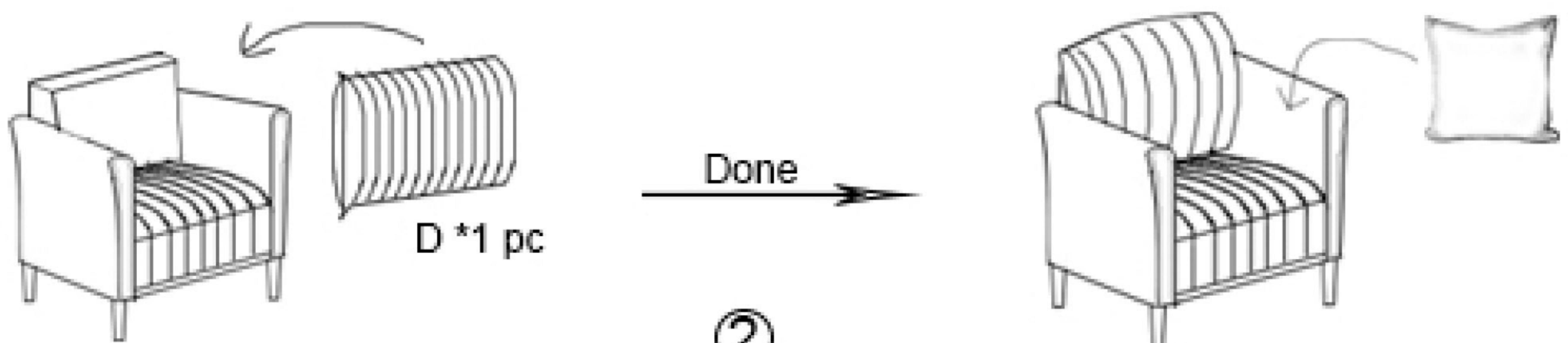





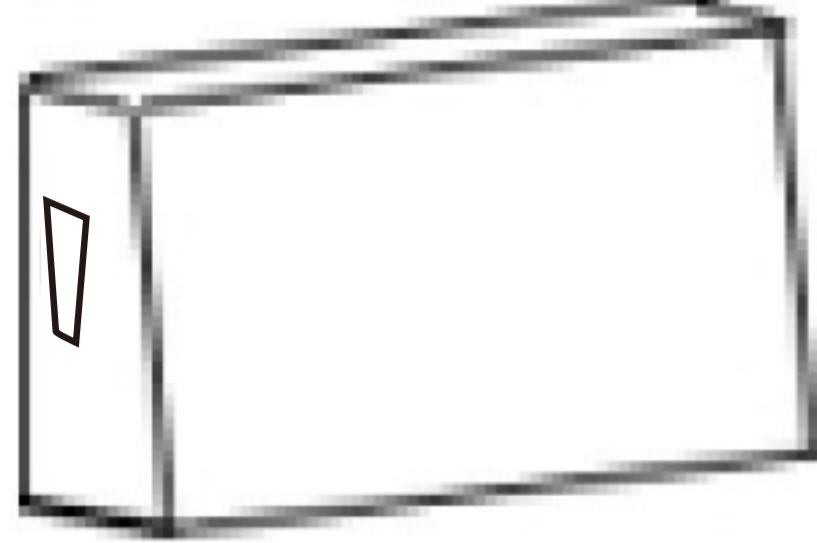
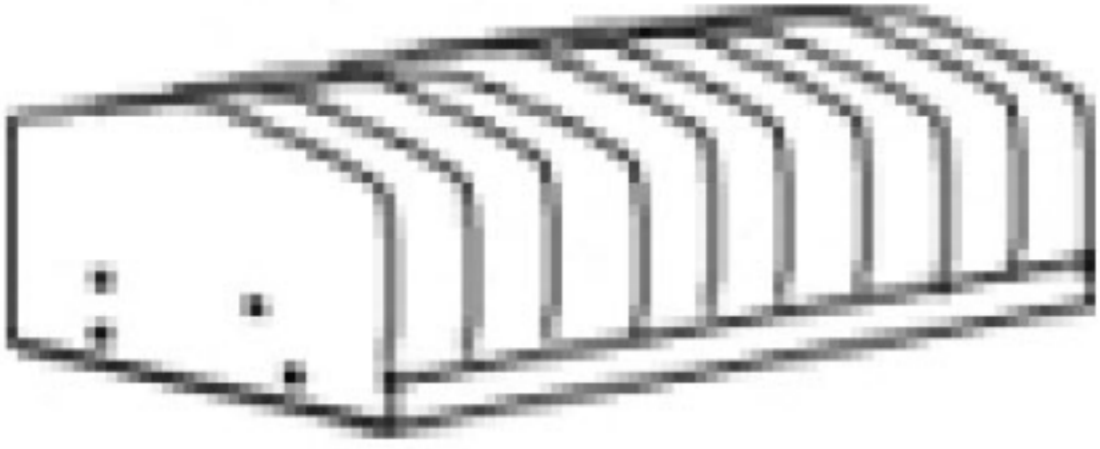
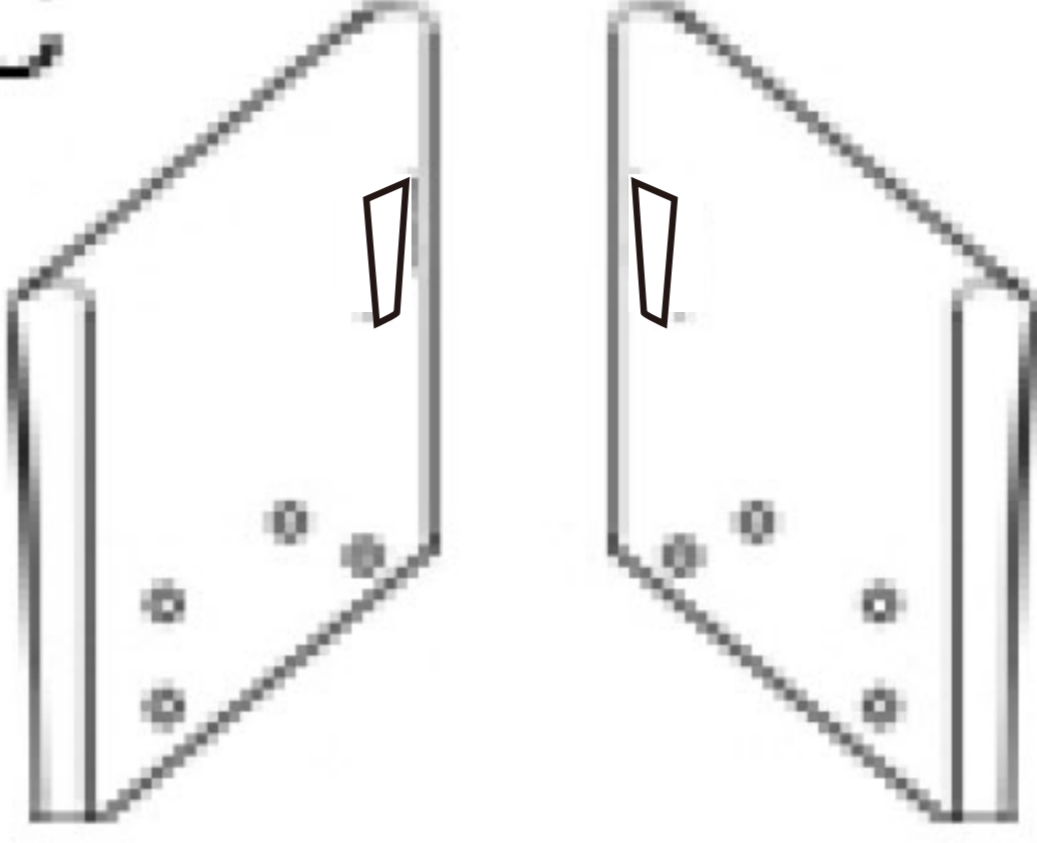
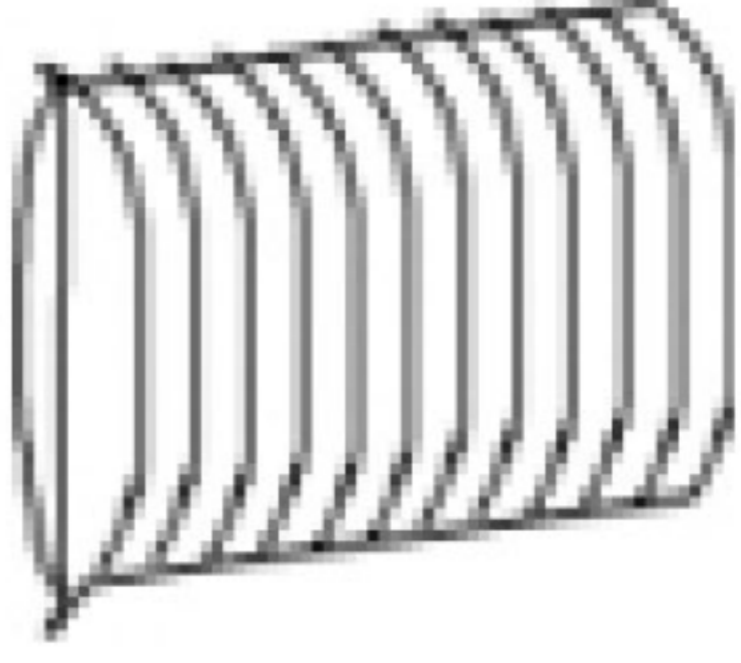
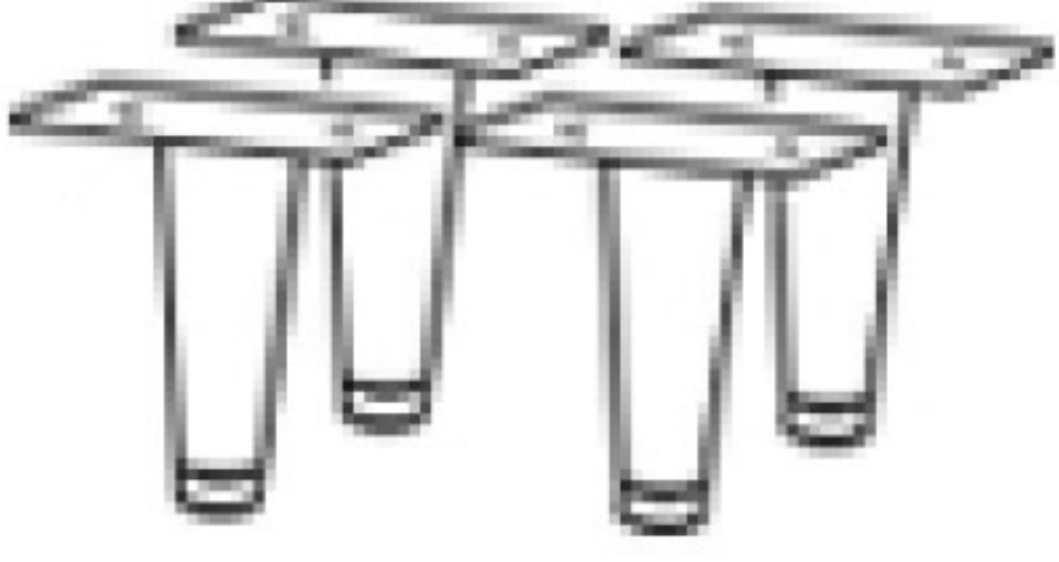

Put the toss pillow on the seat.



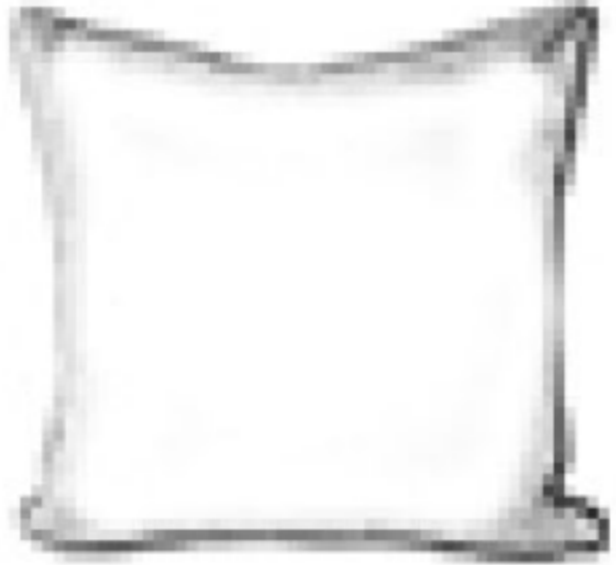

**IF YOU BUY A 2 SEAT SOFA**  
please follow below assembly instruction

**Parts included**

<p><b>A</b></p>  <p>Backrest 2 pcs</p>	<p><b>B</b></p>  <p>Seat 2 pcs</p>	<p><b>C</b></p>  <p>Arm 2PCS</p>	<p><b>D</b></p>  <p>Back pillow 2 pcs</p>	<p><b>E - 1</b></p>  <p>Tapered leg 4 pcs</p>
<p><b>F</b></p>  <p>Bolt M8*75mm*12 pcs</p>	<p><b>G</b></p>  <p>Washer 32 pcs</p>	<p><b>H</b></p>  <p>Allen key 1 pc</p>	<p><b>M - 2</b></p>  <p>Center legs 2 pcs</p>	<p><b>N</b></p>  <p>Bolt M8*30mm*12 pcs</p>
<p><b>L</b></p>  <p>Bolt M8*100mm*4 pcs</p>	<p><b>Y</b></p>  <p>Spring ring 28 pc</p>	<p><b>Z</b></p>  <p>Toss pillow 2 pcs</p>	<p><b>W</b></p>  <p>Nut M8 * 4 pcs</p>	

**Assembly steps**

**Step1**

**A \* 2 pcs**

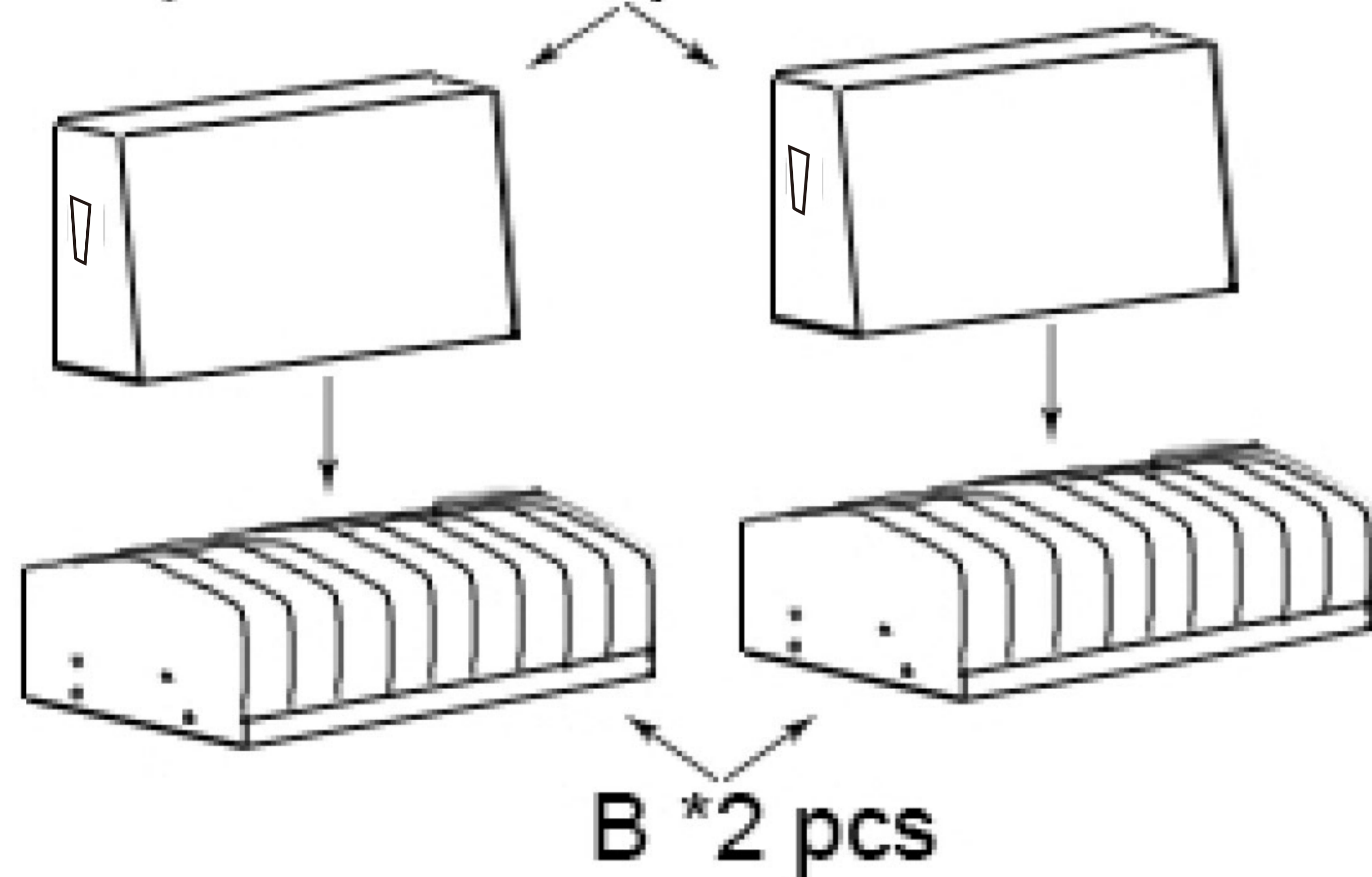

There are four screw holes

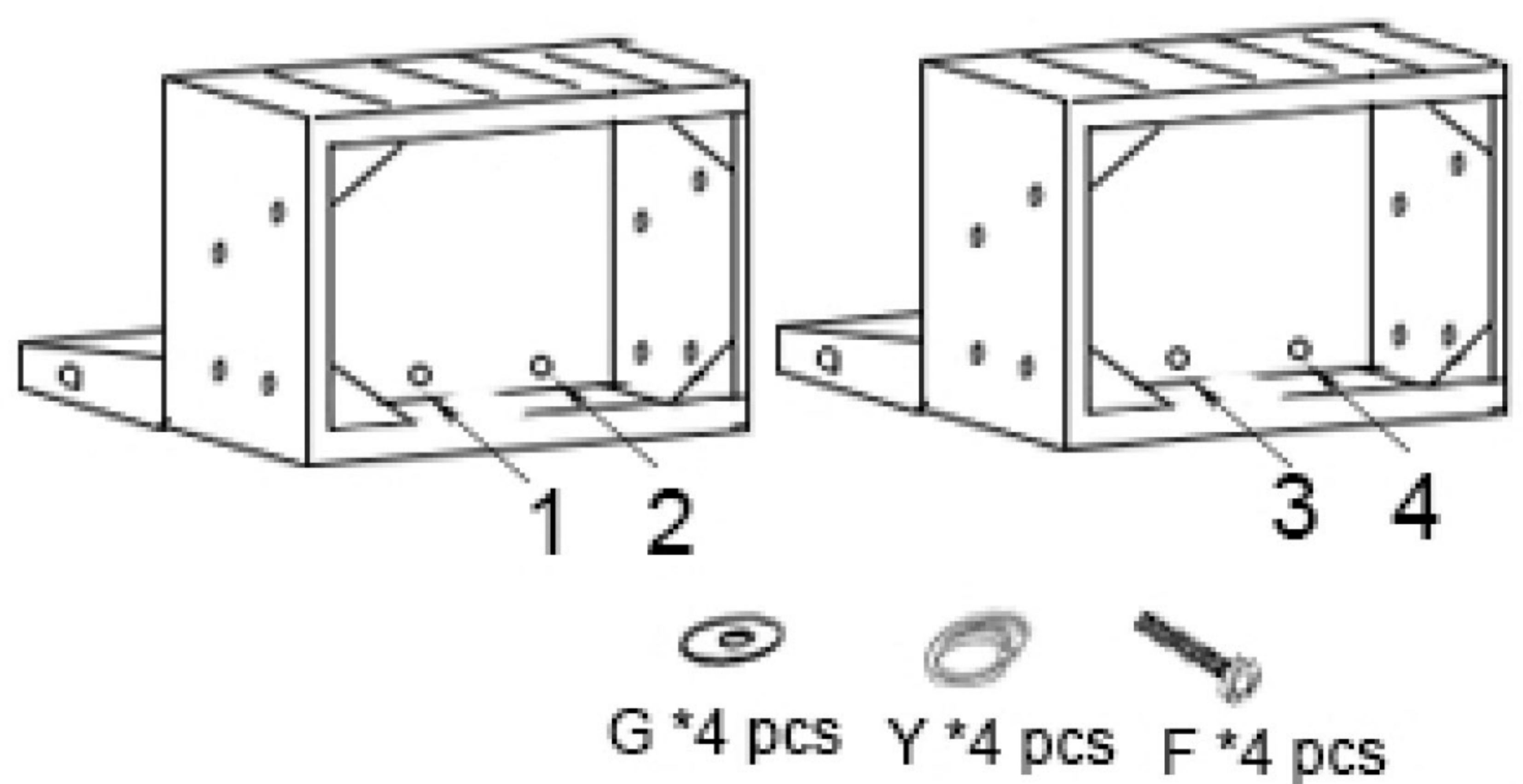

**Step2**

Connect the seat section with screws.

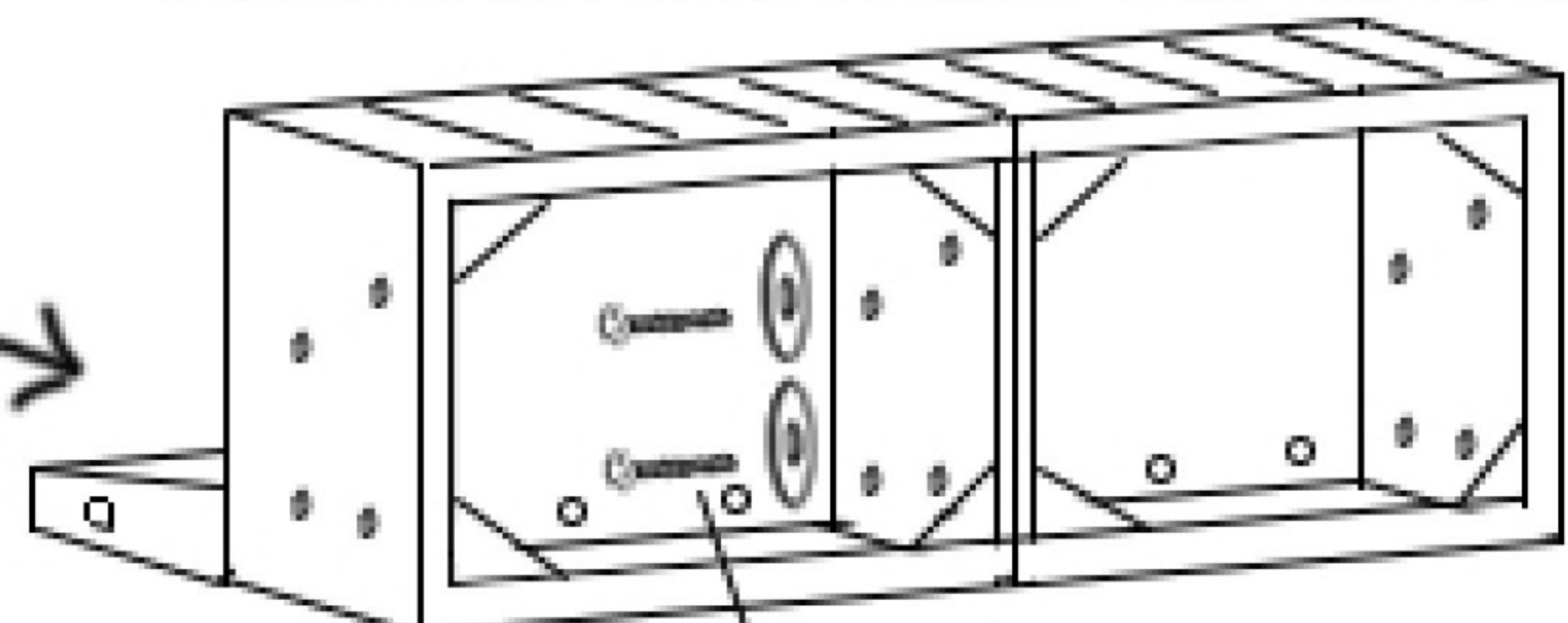
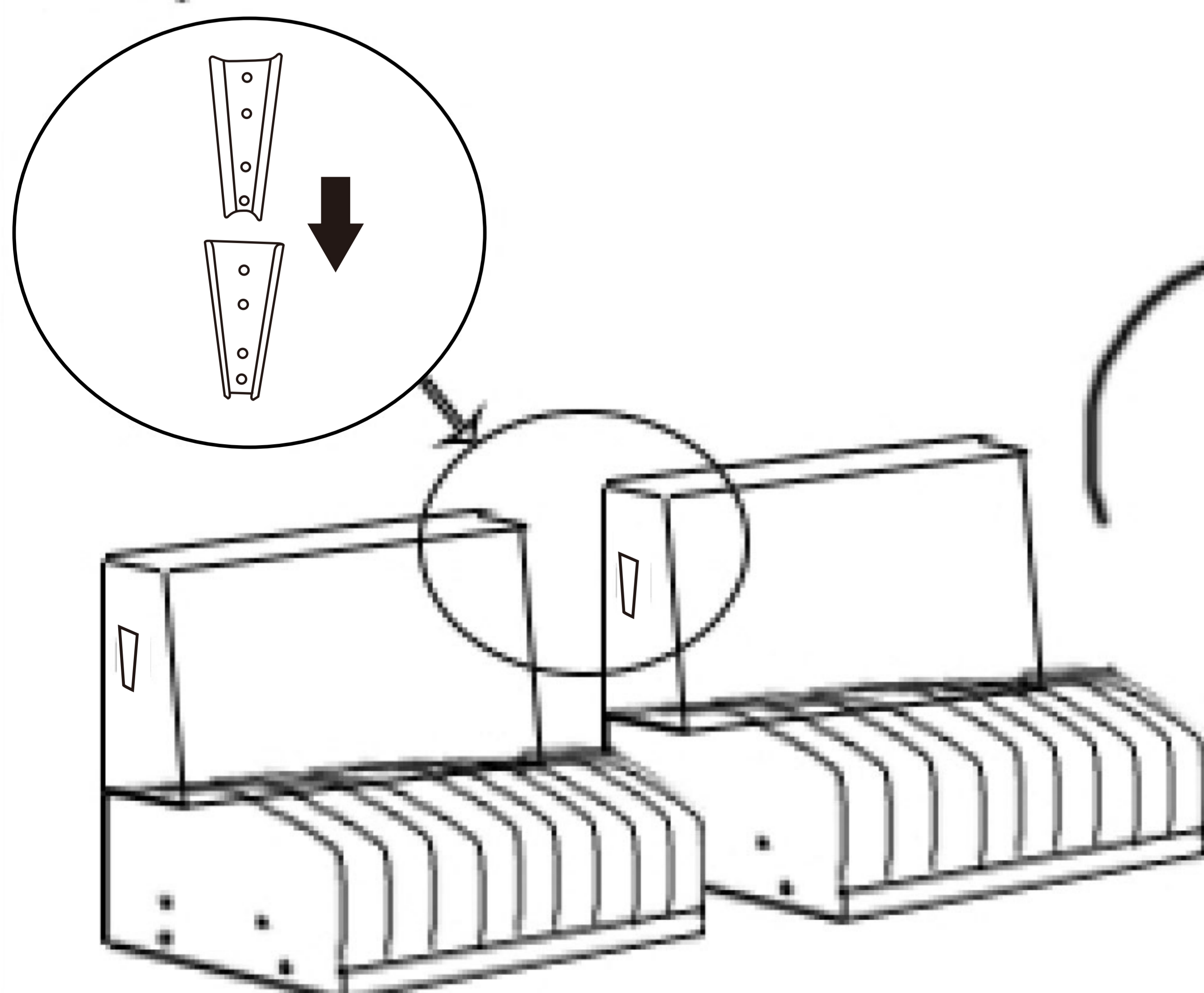

L \* 4 pcs + Y \* 4 pcs + G \* 8 pcs + w \* 4 pcs

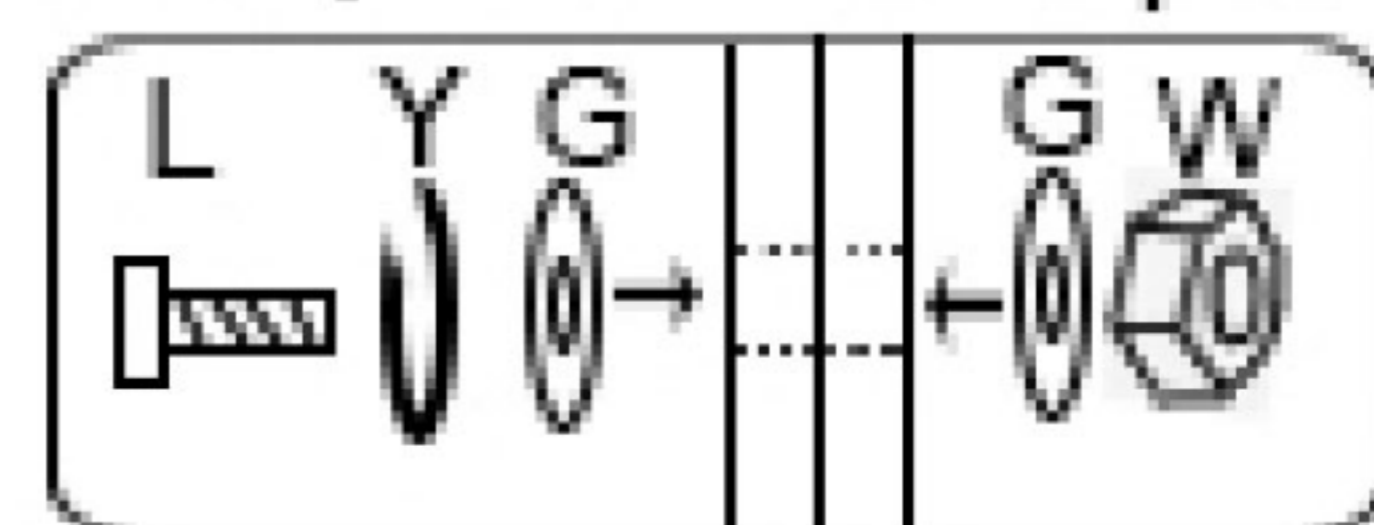

③



**Step4** Secure the hook on arm with the hook on backrest, tighten the arm to seat apron with screws and washers; do it the same for the other arm.

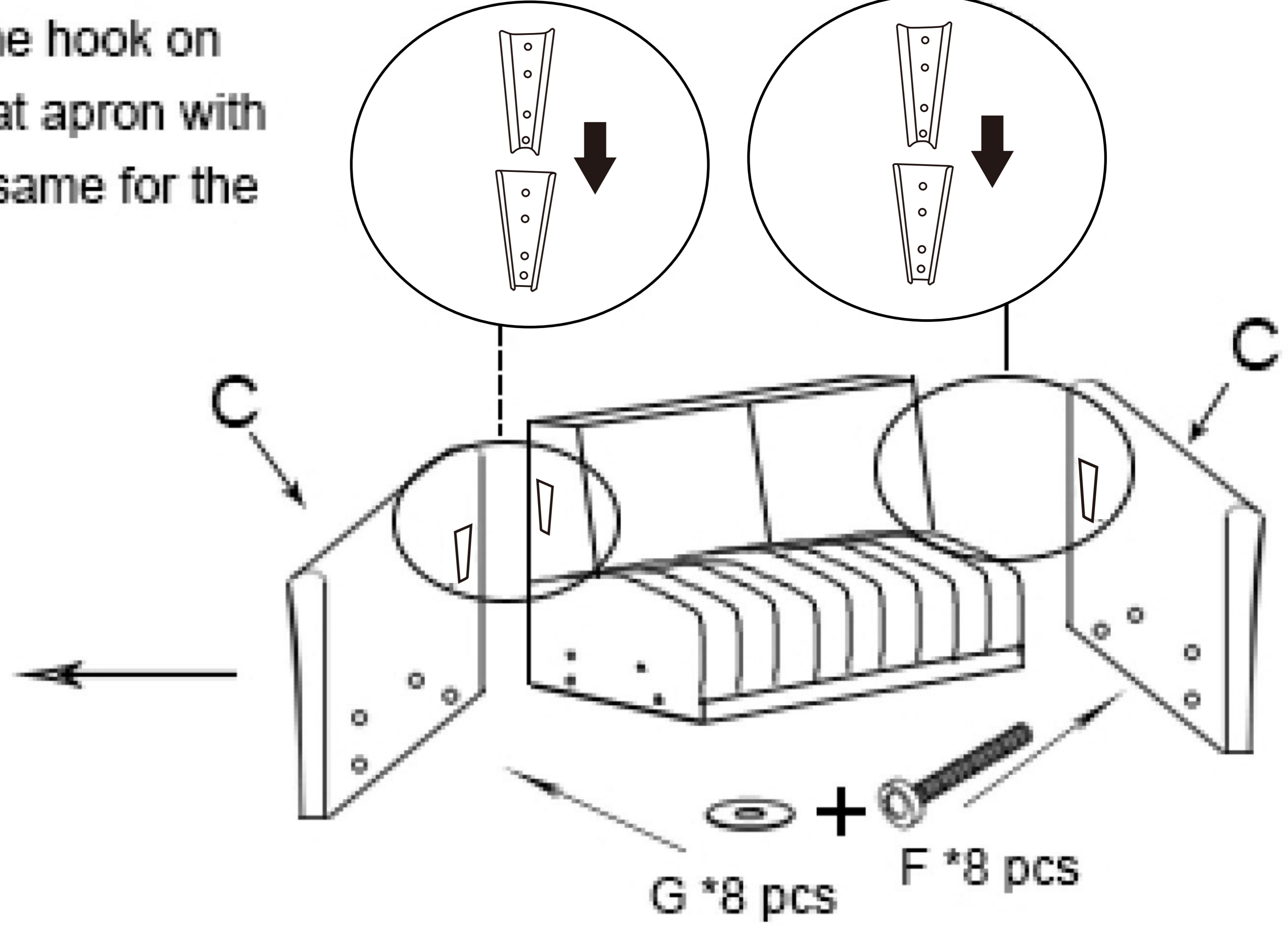
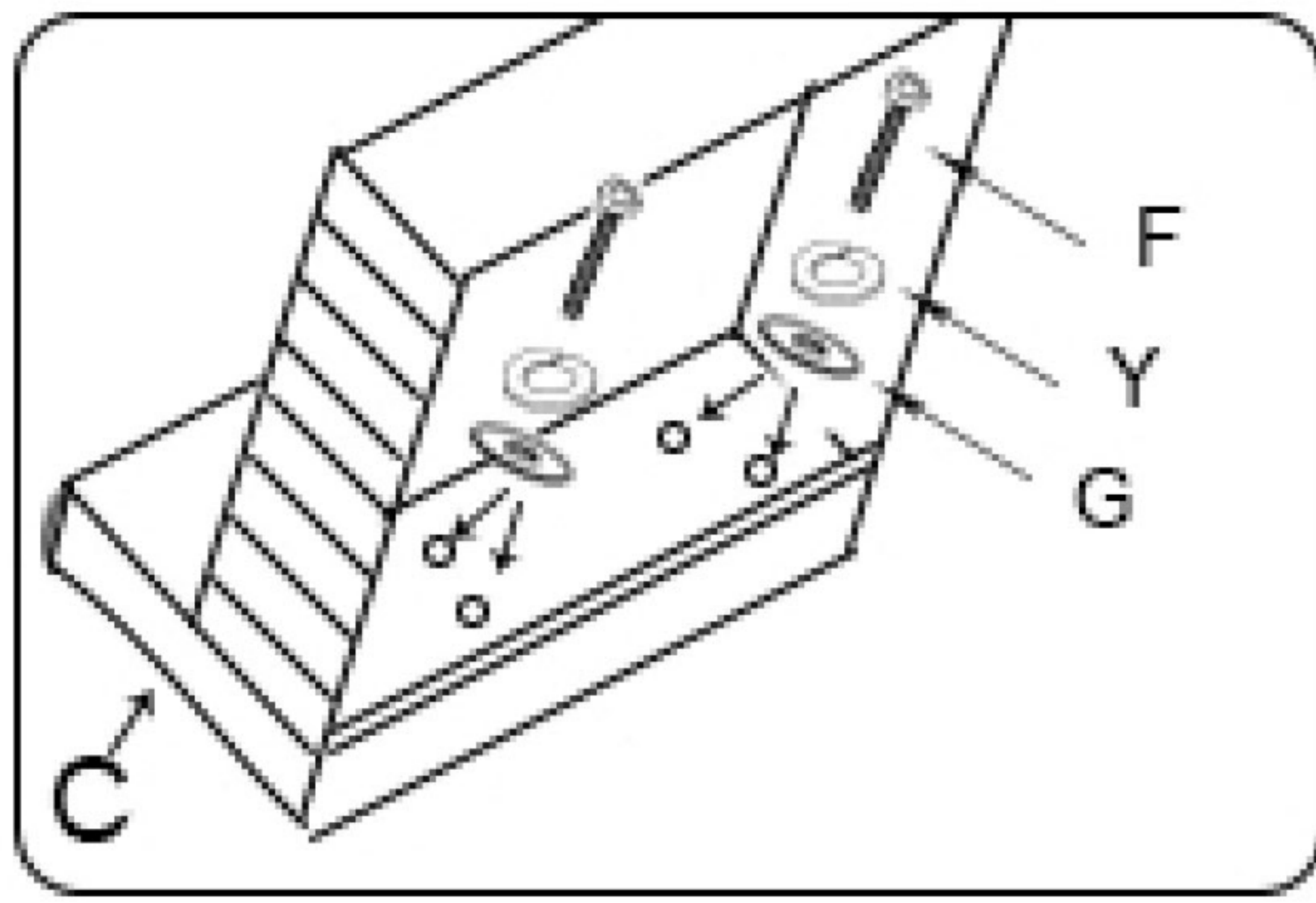

**Step5** Assemble the legs to the bottom of arms and bottom of seats.

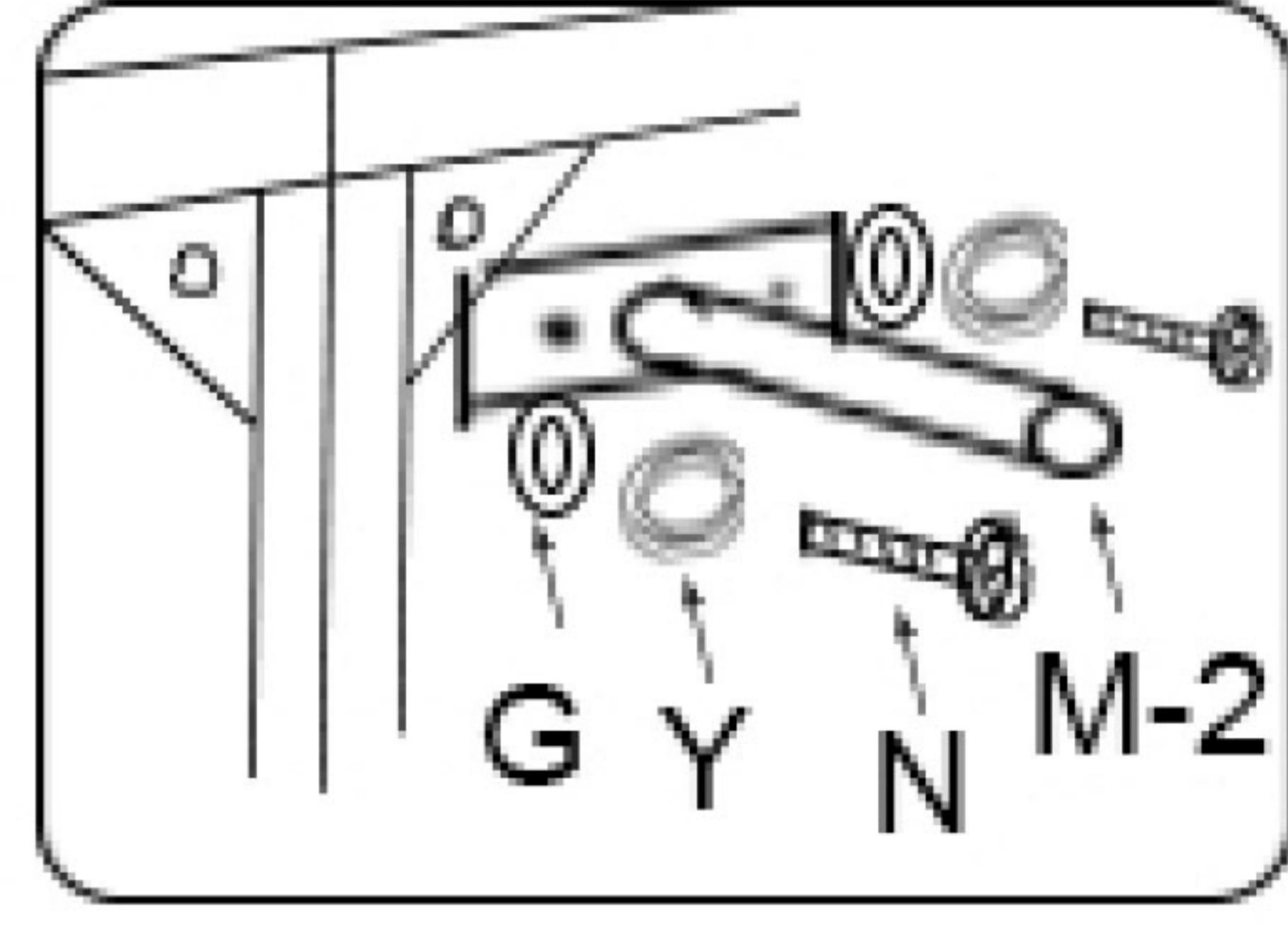
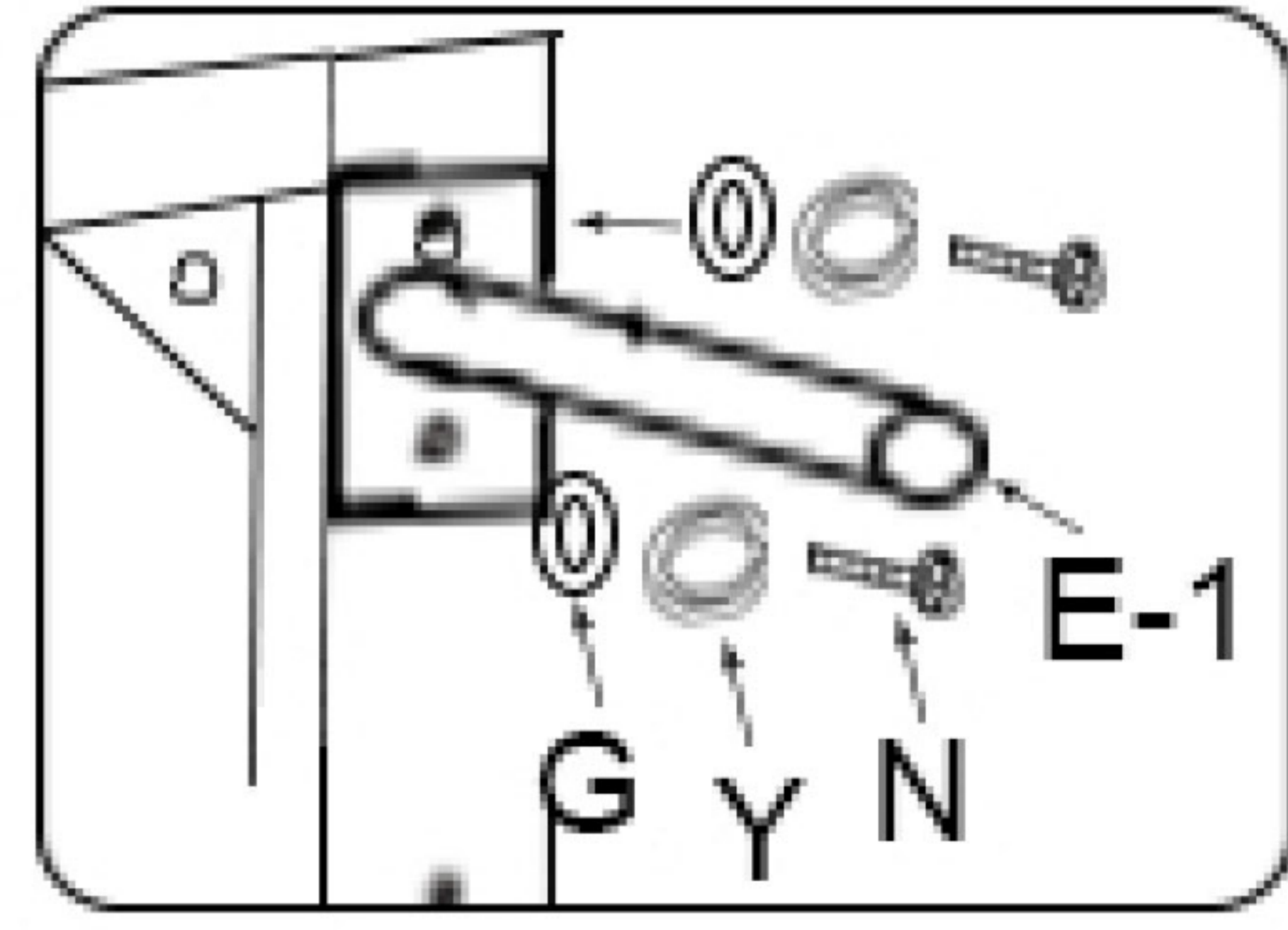
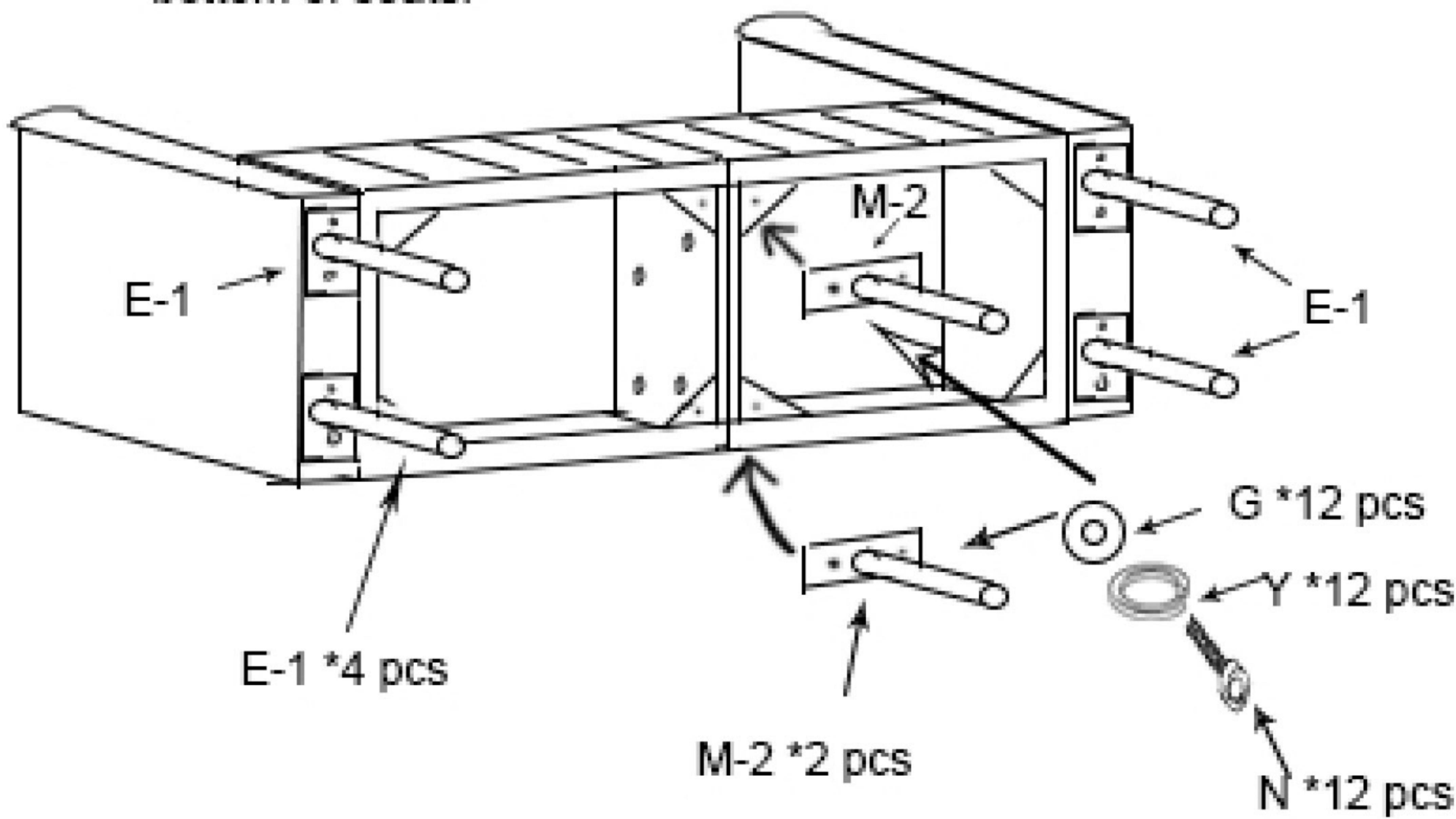



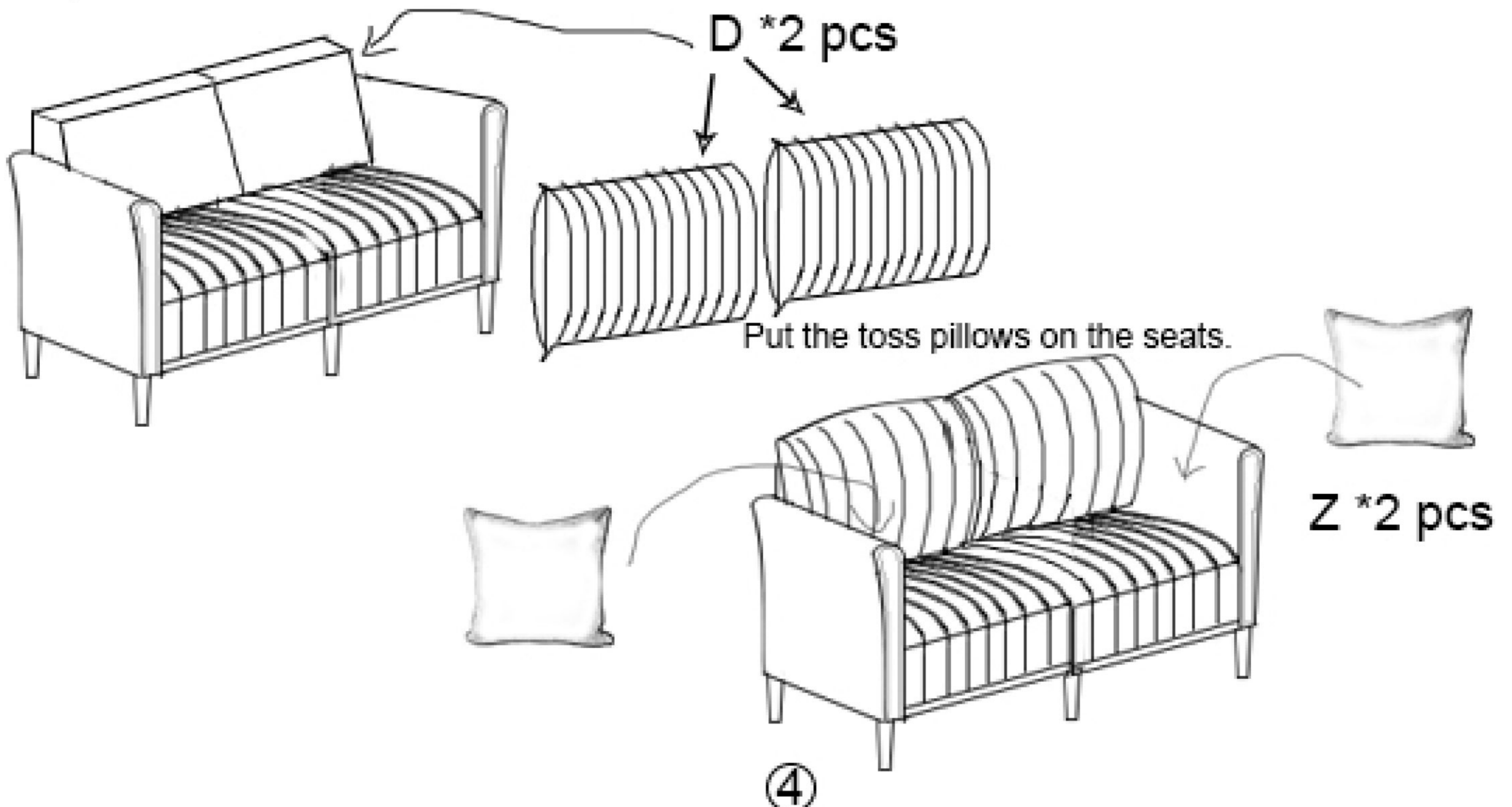





**Step6** Put the pillow on front of the back panel

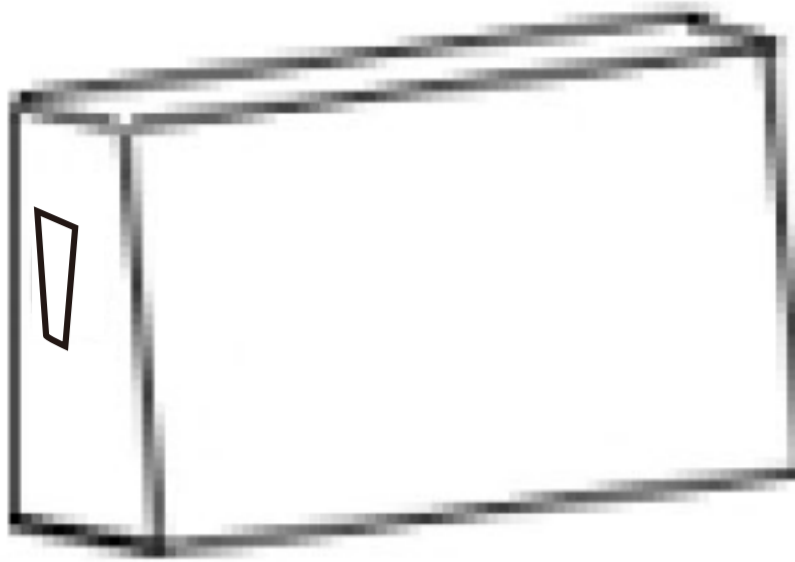
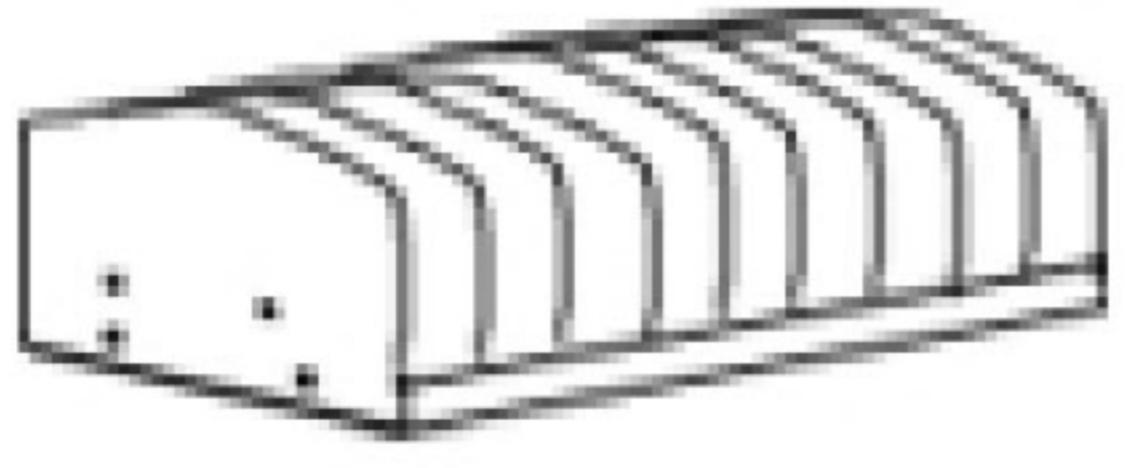
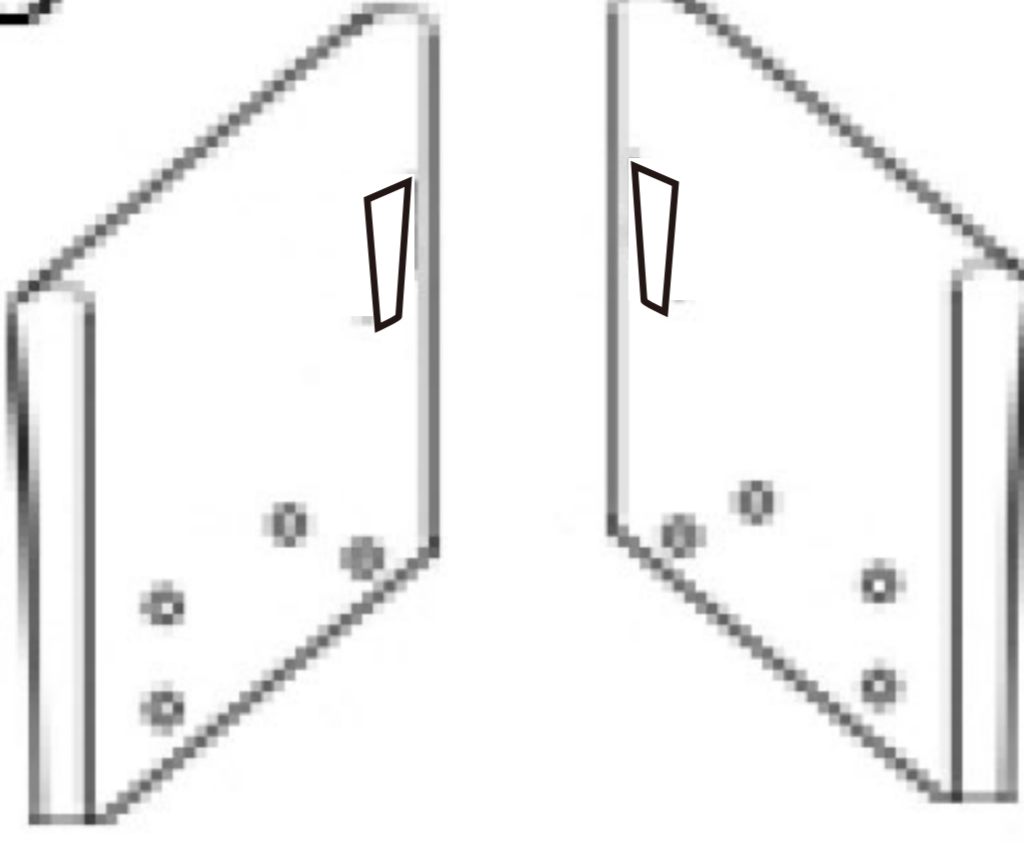
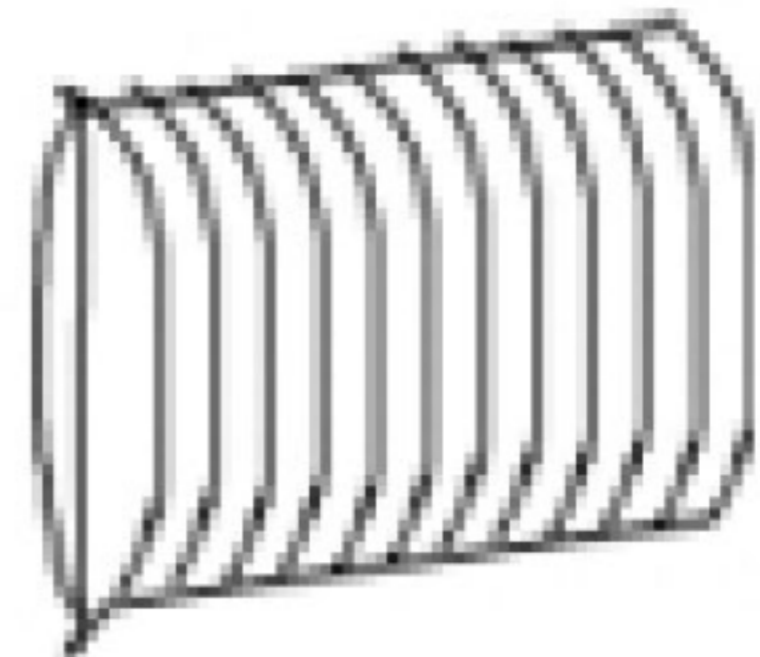
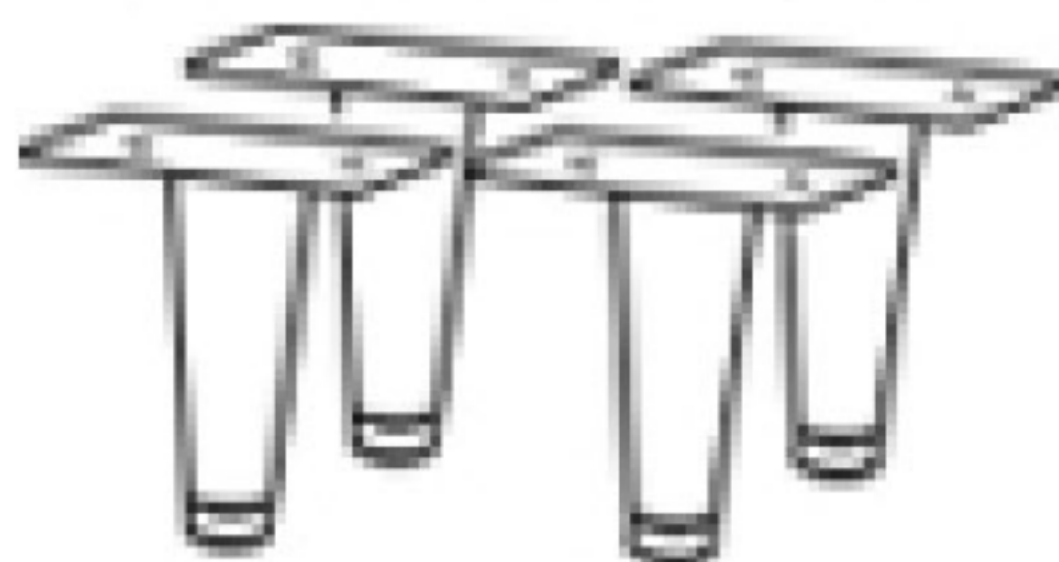

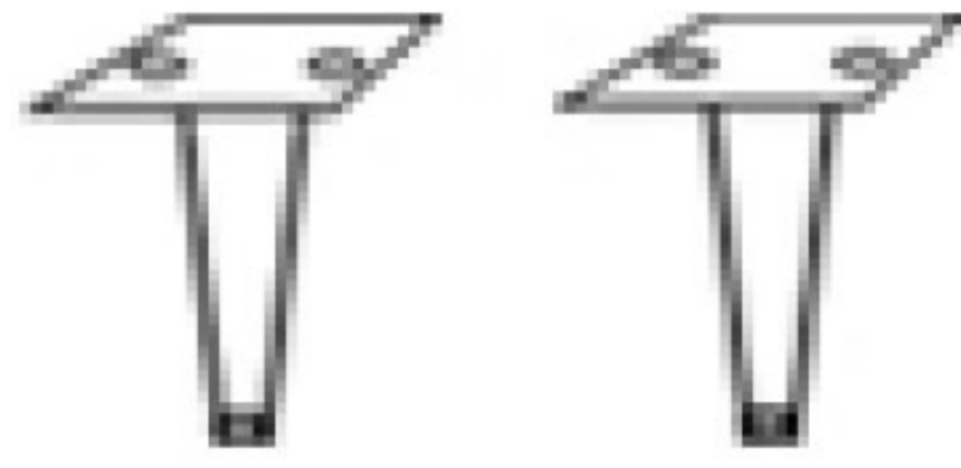

**IF YOU BUY A 3 SEAT SOFA**  
please follow below assembly instruction

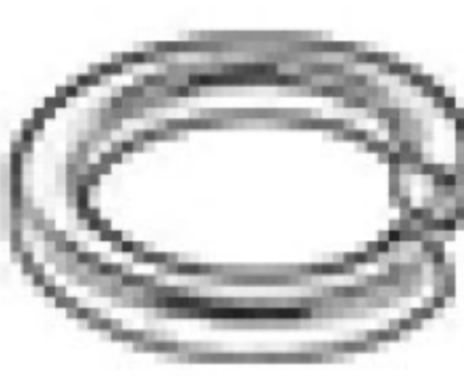
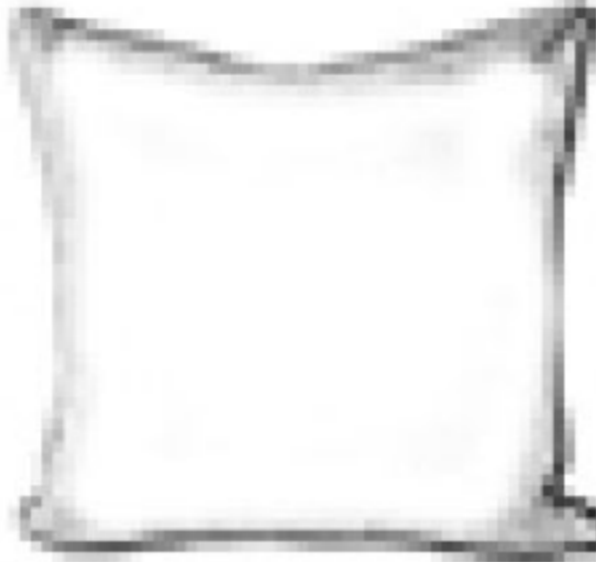
**Parts included**

<p><b>A</b></p>  <p>Backrest 3 pcs</p>	<p><b>B</b></p>  <p>Seat 3 pcs</p>	<p><b>C</b></p>  <p>Armrest 2 pcs</p>	<p><b>D</b></p>  <p>Back pillow 3 pcs</p>	<p><b>E - 1</b></p>  <p>Tapered leg 4 pcs</p>
<p><b>F</b></p>  <p>Bolt M8*75mm*14 pcs</p>	<p><b>G</b></p>  <p>Washer 46 pcs</p>	<p><b>H</b></p>  <p>Allen key 1PC</p>	<p><b>M - 2</b></p>  <p>Center legs 4 pcs</p>	<p><b>N</b></p>  <p>Bolt M8*30mm*16pcs</p>
<p><b>L</b></p>  <p>Bolt M8*100mm*8pcs</p>	<p><b>Y</b></p>  <p>Spring ring 38 pc</p>	<p><b>Z</b></p>  <p>Toss pillow 3 pcs</p>	<p><b>W</b></p>  <p>Nut M8 * 8pcs</p>	

**Assembly steps**

**Step1** Assemble the backrests with seats.

There two screw holes for each section;  
do it the same for other 2 sections once finished.

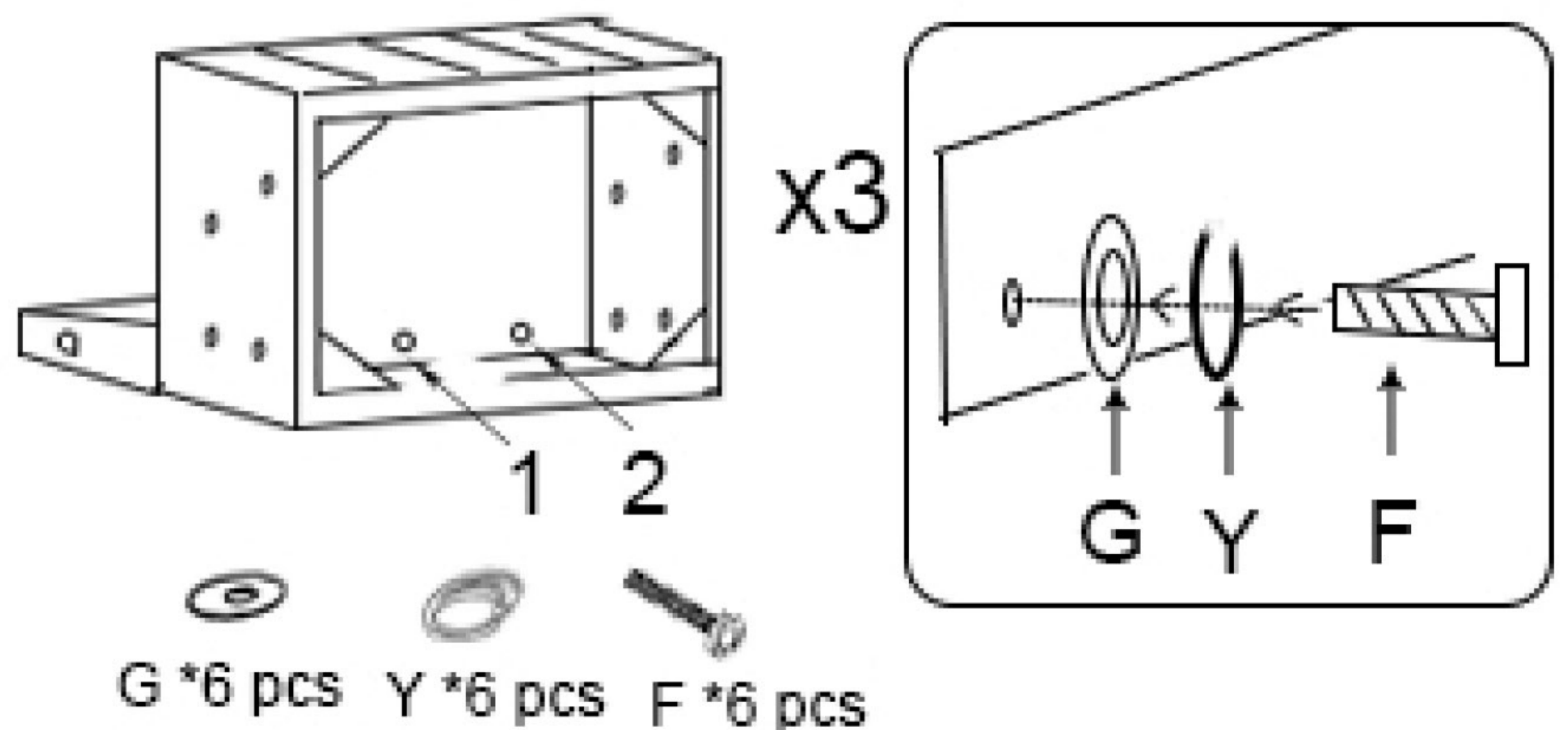
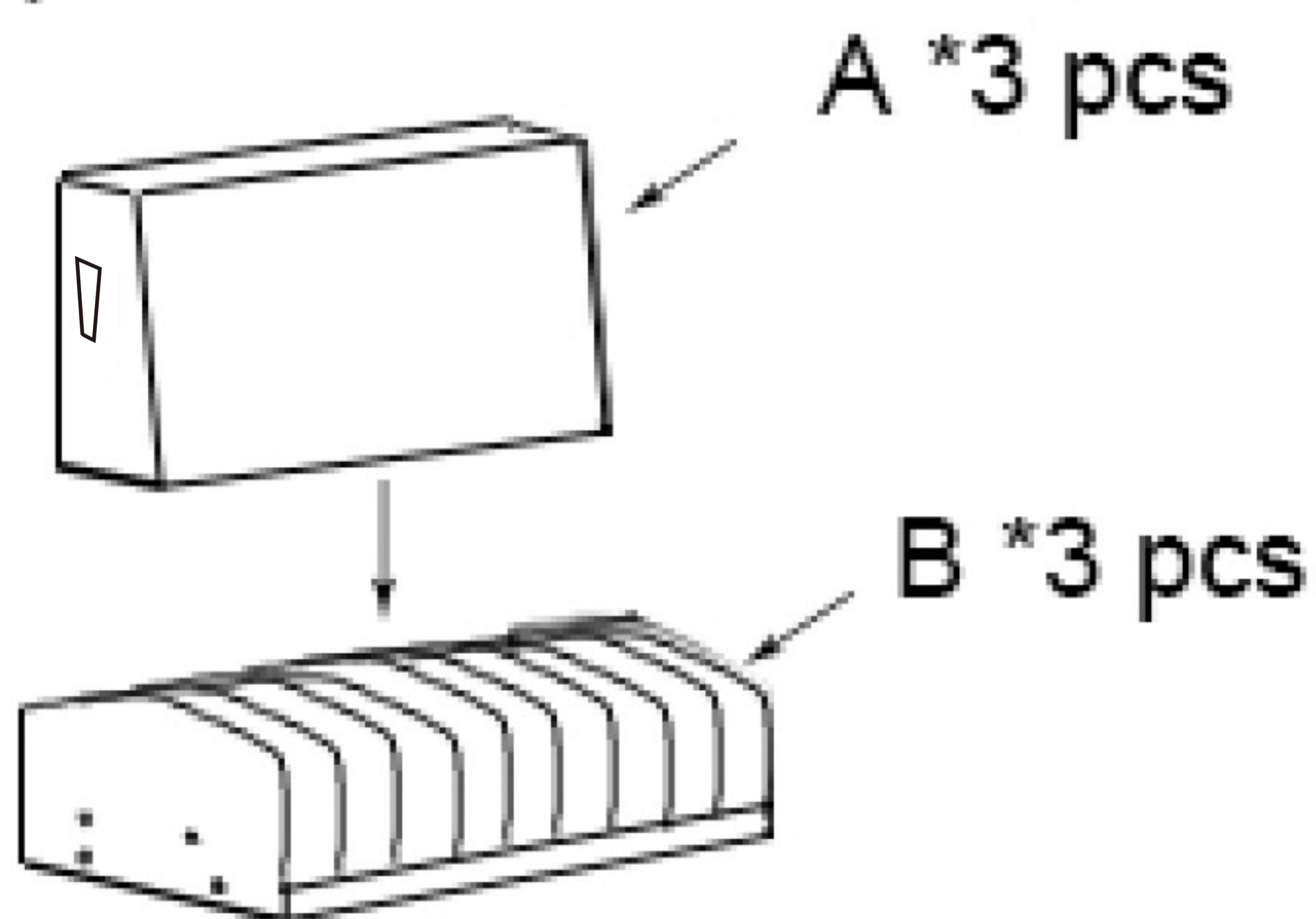

**Step2** Connect the three sections together.

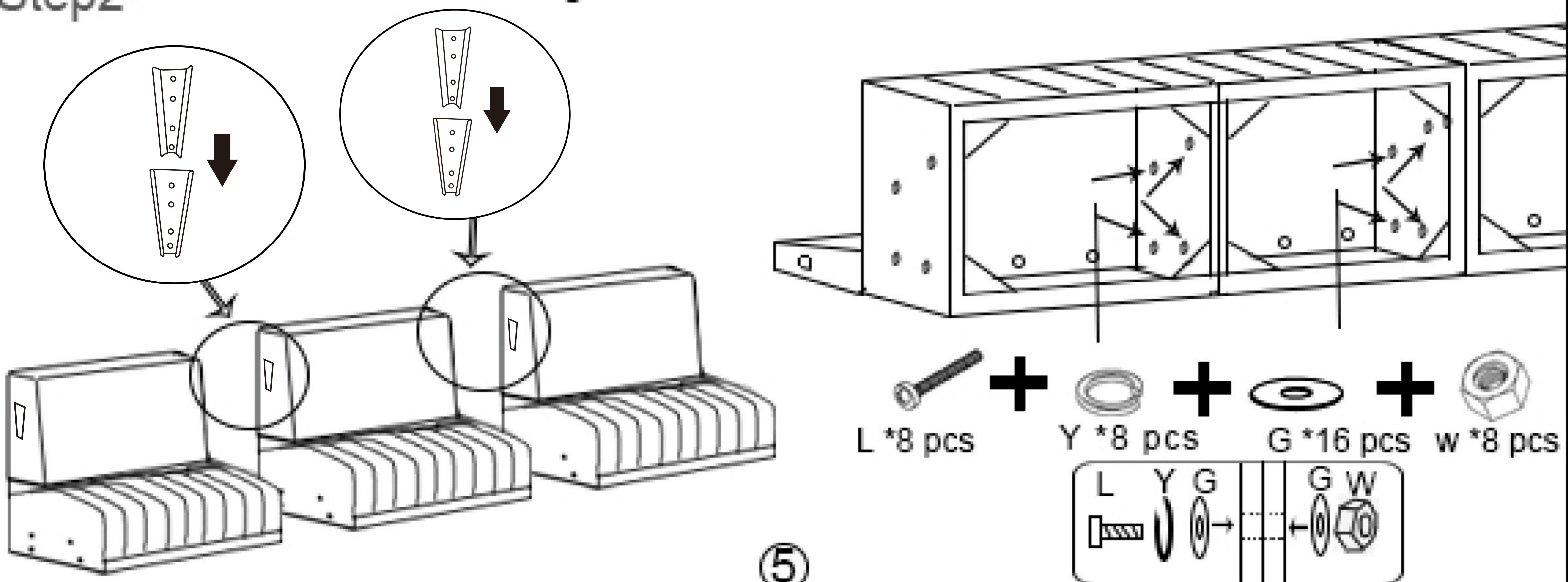



**Step3** Secure the hook on arm with the hook on backrest, tighten the arm to seat apron with screws and washers; do it the same for the other arm.

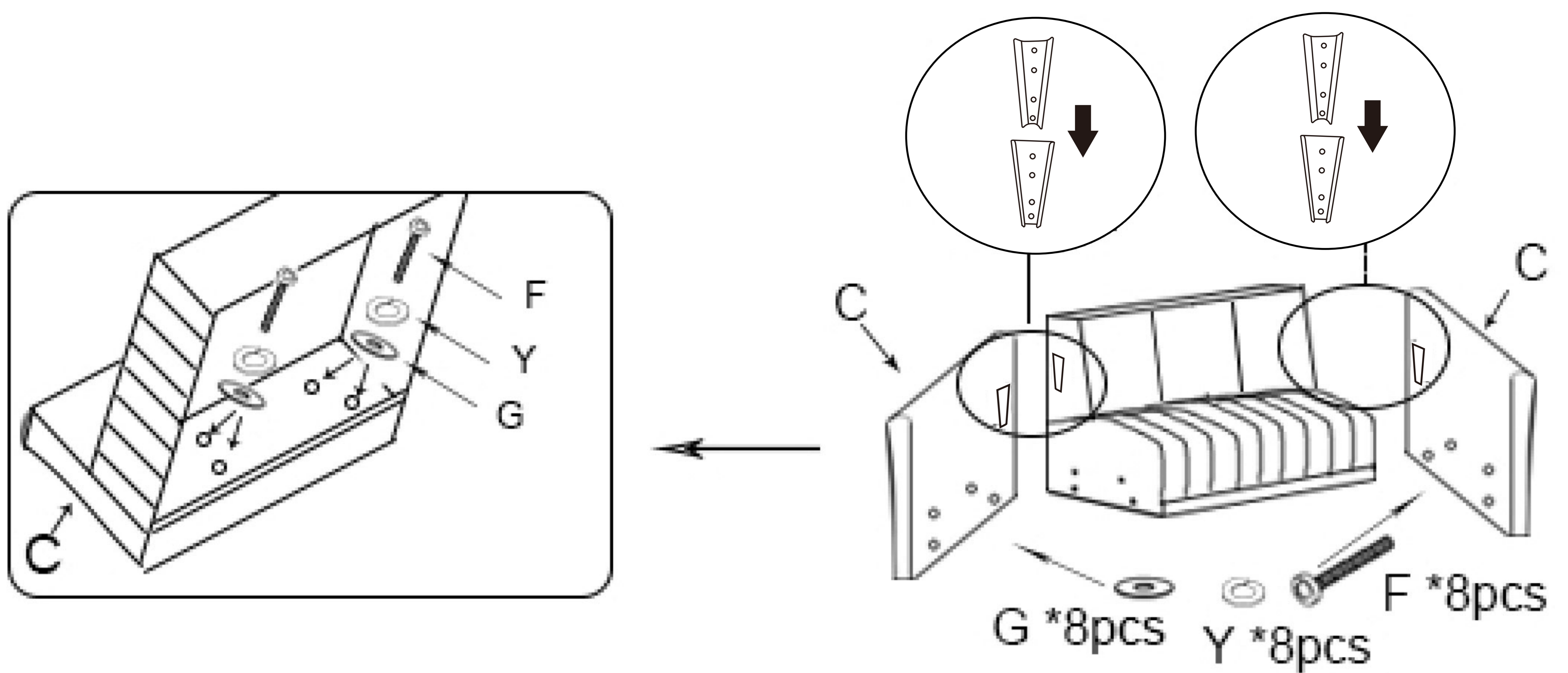

**Step4** Assemble the legs to the bottom of arms and bottom of seats.

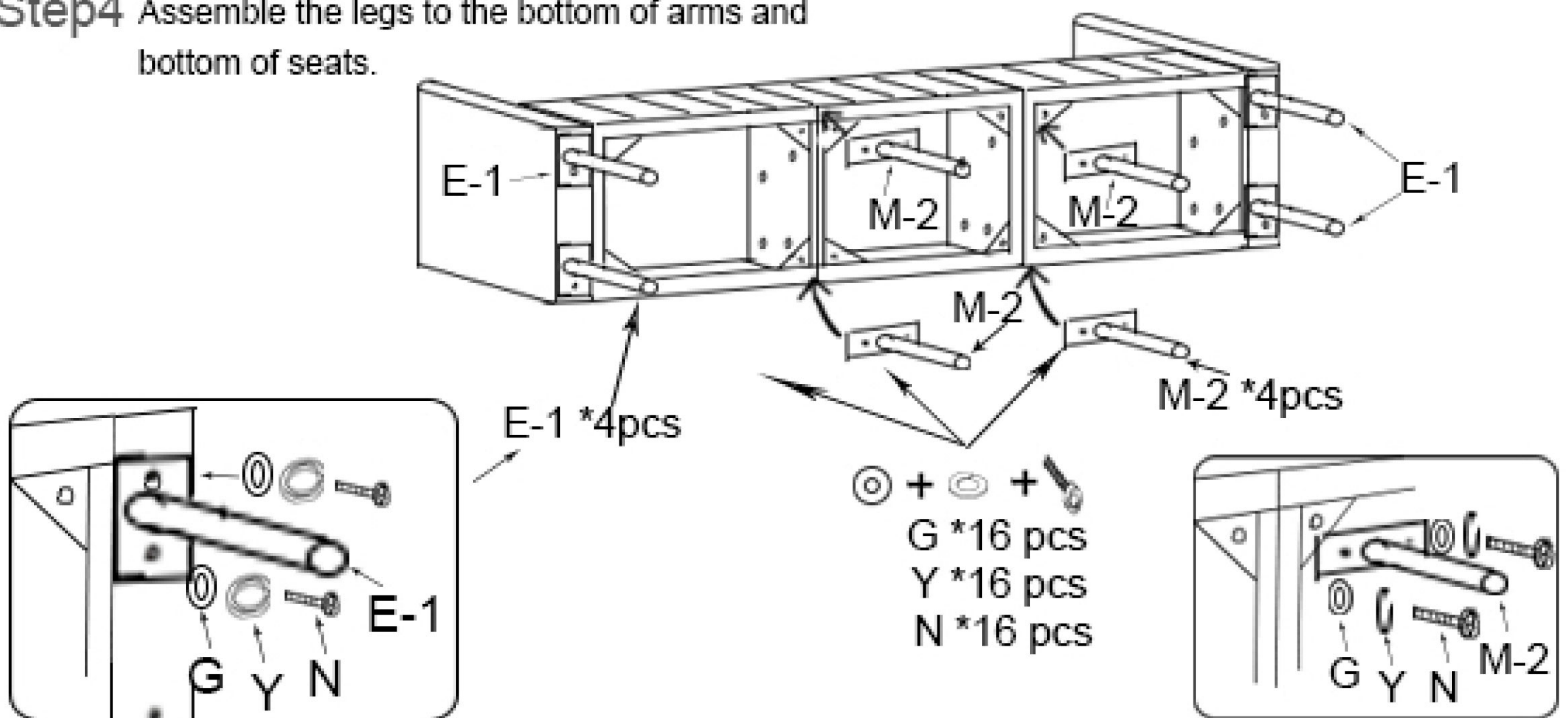

**Step5** Put the pillow on front of the back panel

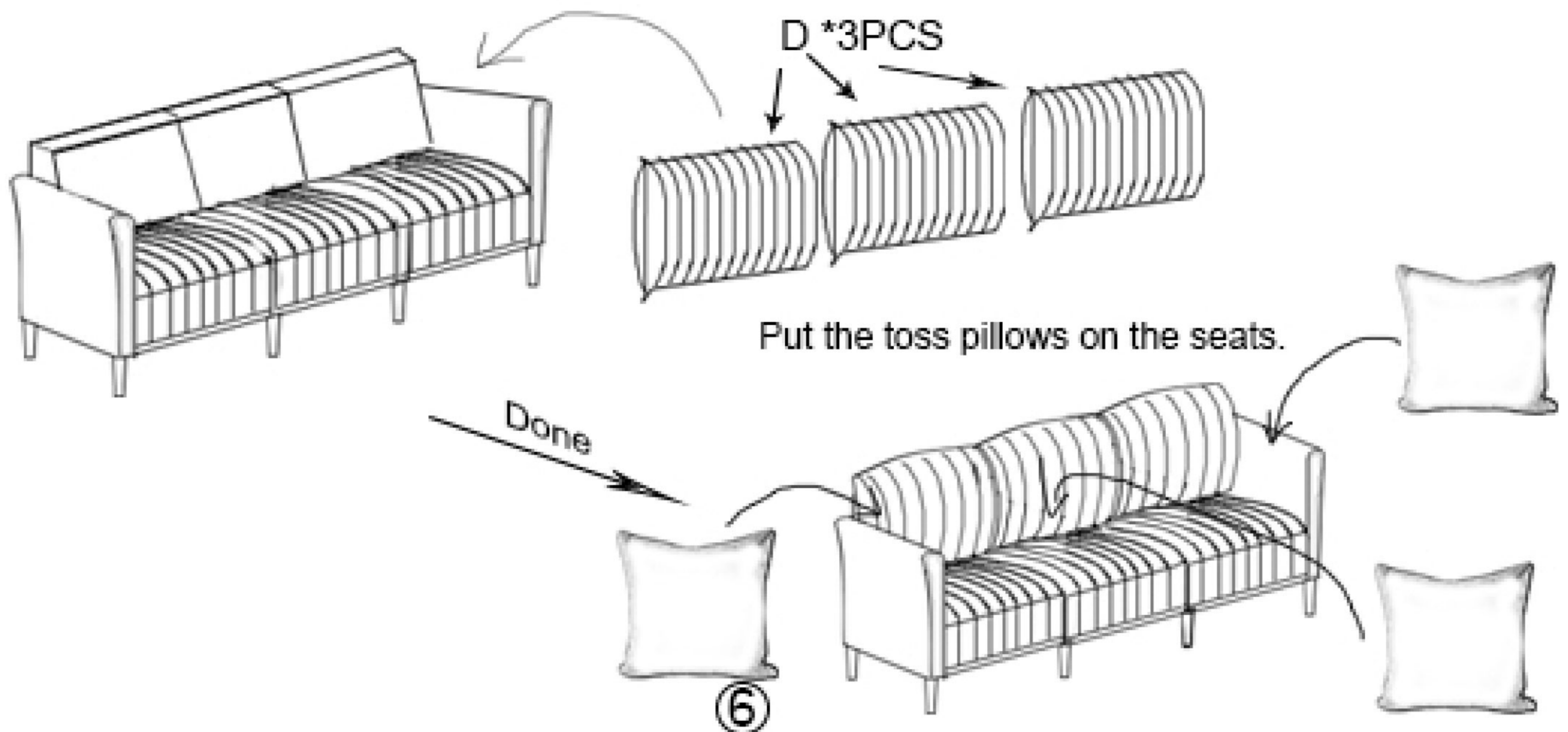



# Care & Maintenance



Warnings

Whether you need to address a stubborn stain or just want to keep your sofa looking beautiful for as long as possible, the best source of information is your sofa's manufacturer. However, there are a few general tips to keep in mind when caring for and cleaning your sofa.

## Caring For Your Sofa

- If possible, rotate the cushions and pillows on your sofa every week for even wear.
- For fabric upholstery, weekly vacuuming will keep your sofa fresh by removing any loose particles.

Leather furniture should be dusted weekly with a soft cloth and treated with a conditioner every 6-12 months to keep it soft and lustrous.

- Professional cleaning is recommended about once a year.
- If fading is a concern (for both fabric and leather), take extra care to avoid placing your sofa in direct sunlight.

## Cleaning Your Sofa

- Sometimes, spot cleaning can cause a wet-looking ring or fading. It's always best to have the entire piece cleaned by a professional. However, if you decide to clean on your own, check the cleaning code on your piece of furniture. (This may be found in the packaging information, under a cushion, or on the bottom of the sofa.)
- On fabric sofas, blot (don't rub!) spills as soon as possible with a clean, absorbent white cloth. Blot from the outside inward to prevent a ring from forming. If the upholstery fabric has a thick pile, you may try brushing the fabric with a stiff bristle brush. If you are going to treat a stain with a cleaning agent, test it ahead of time in a small, hidden area.
- On leather sofas, most spills can just be wiped away. However, old stains can be treated with lukewarm water.



## Questions & Answers about Proposition 65

### ●What is Proposition 65?

Proposition 65 requires businesses to provide warnings to Californians about significant exposures to chemicals that cause cancer, birth defects or other reproductive harm. These chemicals can be in the products that Californians purchase, in their homes or workplaces, or that are released into the environment. By requiring that this information be provided, Proposition 65 enables Californians to make informed decisions about their exposures to these chemicals. Proposition 65 also prohibits California businesses from knowingly discharging significant amounts of listed chemicals into sources of drinking water.

Proposition 65 requires California to publish a list of chemicals known to cause cancer, birth defects or other reproductive harm. This list, which must be updated at least once a year, has grown to include approximately 900 chemicals since it was first published in 1987.

### ●What types of chemicals are on the Proposition 65 list?

The list contains a wide range of naturally occurring and synthetic chemicals that include additives or ingredients in pesticides, common household products, food, drugs, dyes, or solvents. Listed chemicals may also be used in manufacturing and construction, or they may be byproducts of chemical processes, such as motor vehicle exhaust.

### ●What does a warning mean?

If a warning is placed on a product label or posted or distributed at a workplace, a business, or in rental housing, the business issuing the warning is aware or believes that it is exposing individuals to one or more listed chemicals.

By law, a warning must be given for listed chemicals unless the exposure is low enough to pose no significant risk of cancer or is significantly below levels observed to cause birth defects or other reproductive harm.

### ●Where can I get more information on Proposition 65?

If you have specific questions on the administration or implementation of Proposition 65, you can contact OEHHA's Proposition 65 program at [P65.Questions@oehha.ca.gov](mailto:P65.Questions@oehha.ca.gov), or by phone at (916)445-6900.