

# Assembly Instructions

Caution: You must read this before you proceed

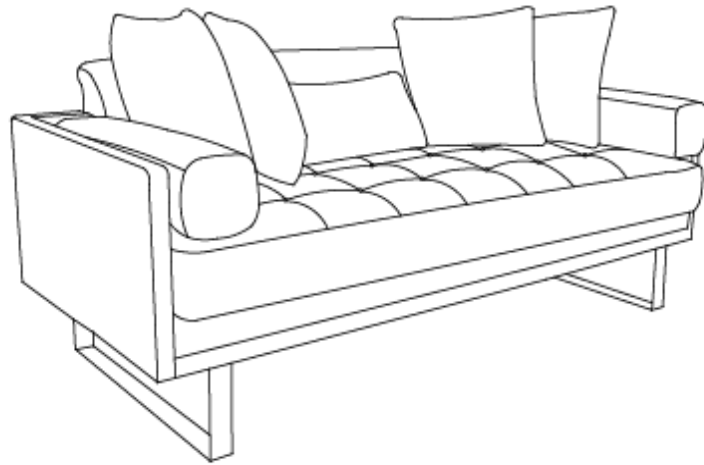



Please look in the small box for hardware packs and legs.



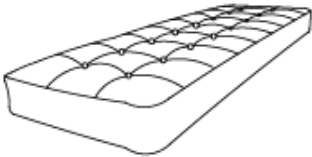
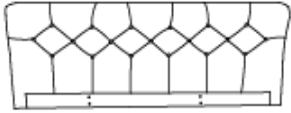
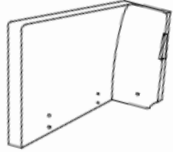
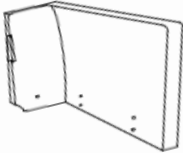

## Sofa

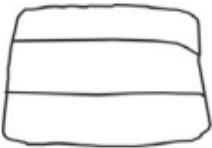



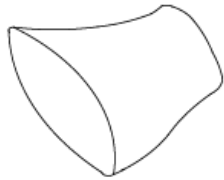

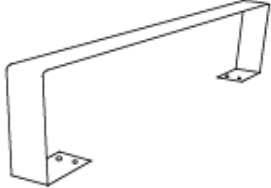
## Parts List



Label	Picture	Description	QTY
A		Sofa Base	1

B		Seat Cushion	1
C		Sofa Backrest	1
D		Left Arm	1
E		Right Arm	1
F		Backrest Cushion Cover(Square)	4
G		Backrest Cushion Interior(Square)	4
H		Backrest Cushion Interior(Rectangle)	1

I		Back Cushion Cover(Rectangle)	1
J		Arm Pillow	2
K		Metal Leg	2
L		Wooden Leg(with Plastic Gasket)	1

## Hardware List

Label	Picture	Description	QTY
①		Bolt(M6*25mm )	9
②		Bolt(M8*70mm )	7
③		Bolt(M6*60mm )	9
④		Washer	25



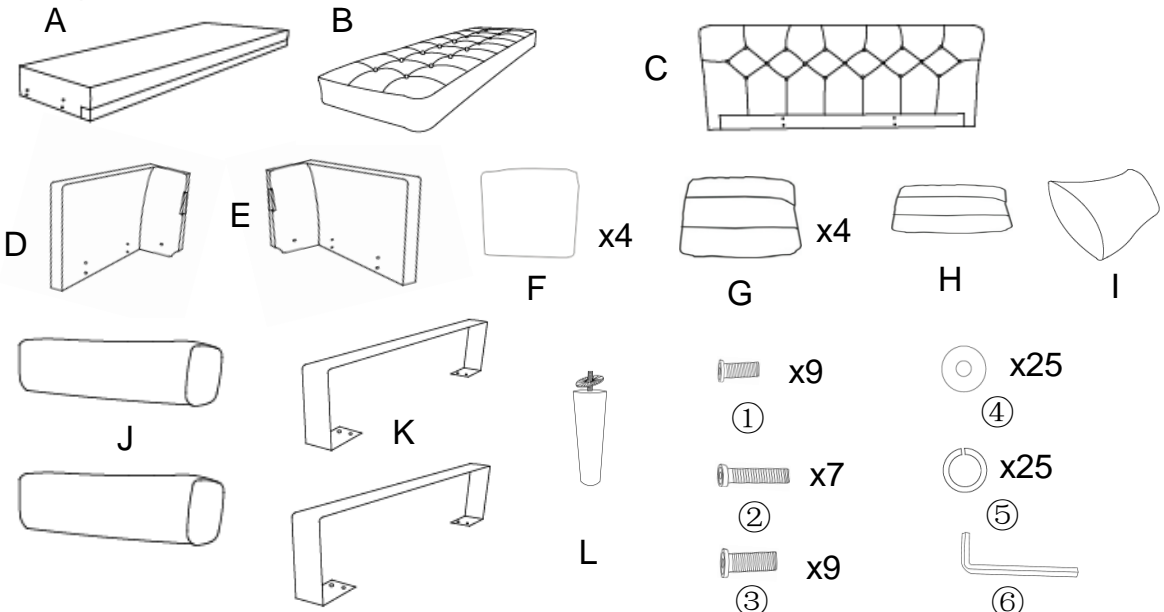

⑤		Spring Washer	25
⑥		Allen Wrench	1

## Assembly Preparation

**Before Beginning Assembly:**



A: Base  
 B: Mattress  
 C: Backrest  
 D, E: Side panels  
 F, G, H: Cushions  
 I: Corner piece  
 J, K, L: Rods  
 ①, ②, ③: Screws  
 ④, ⑤: Washers  
 ⑥: Allen wrench

-  • Read instructions, cover to cover-
-  • Have 2 adults on hand for assembly-
-  • Do not assemble on flooring or carpet-
-  • Assemble on a clean non-marring surface (packing foam)-
-  • Save all packaging until finished-

# Assembly Steps

## Overview

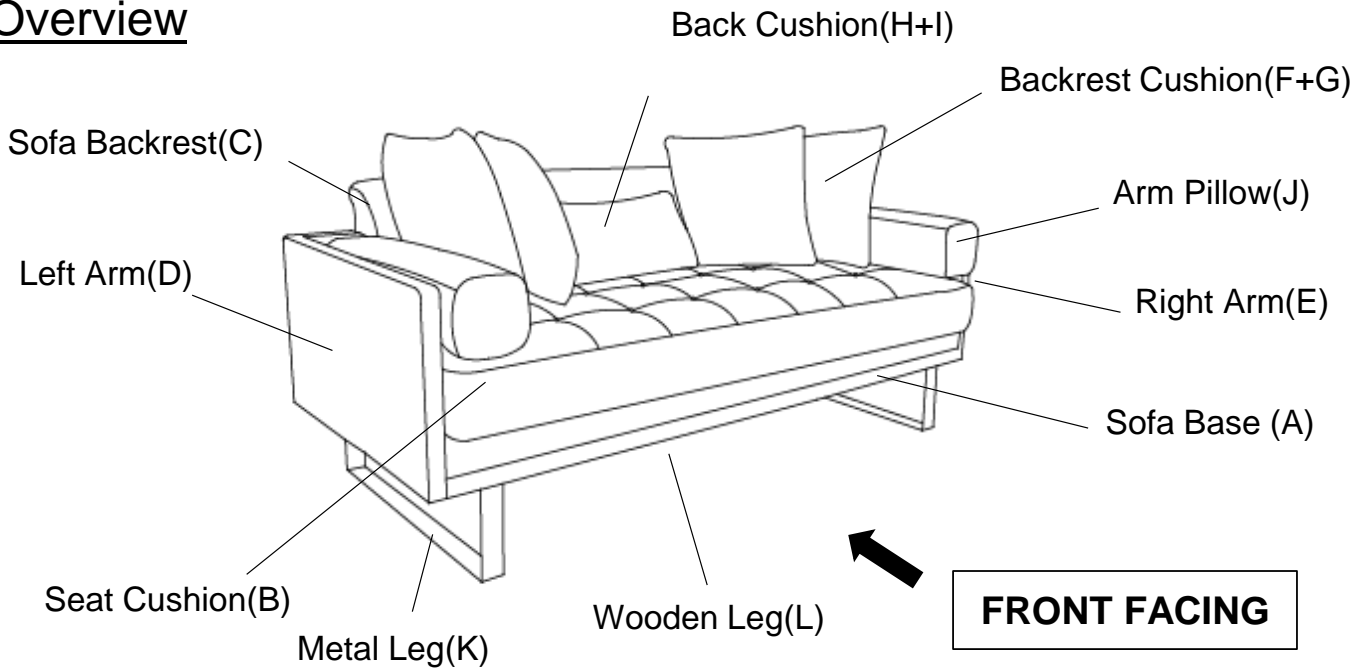

This Sofa has multiple parts and may require about 30 minutes to assemble. To give you an overview of the Sofa parts, the above picture is to help you put the various parts into perspective. Please read through the instructions below to familiarise yourself with the parts and steps before assembly.

## Step 1

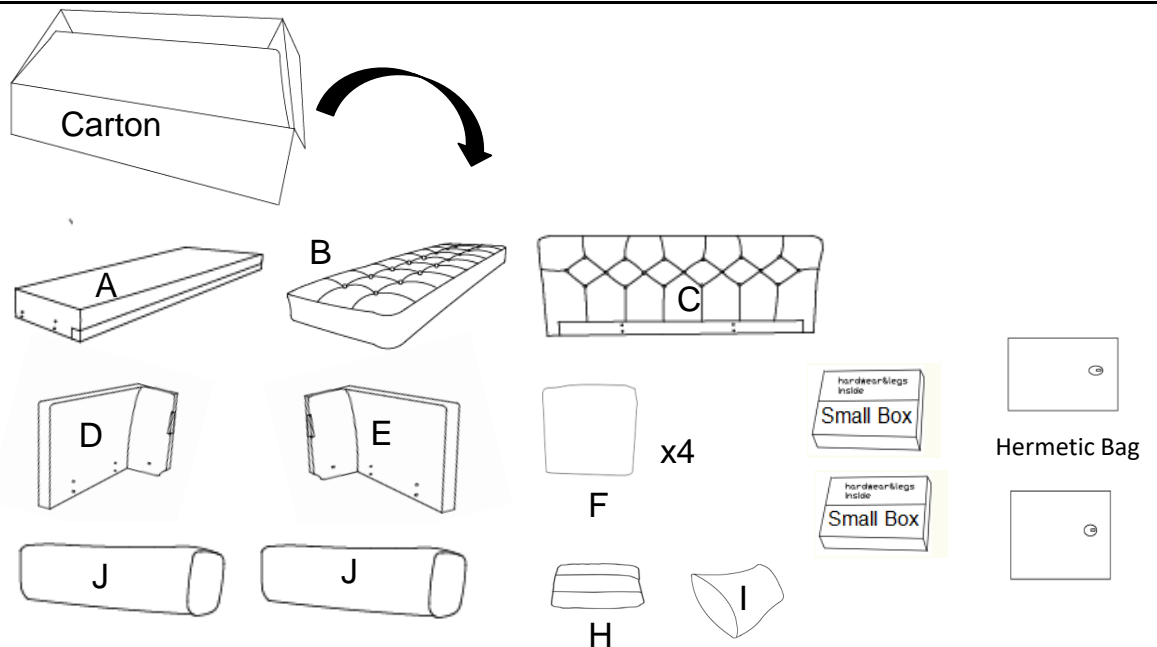

Remove the Sofa Base(A), Seat Cushion(B), Sofa Backrest(C), Left Arm(D), Right Arm(E), Backrest Cushion Cover(Square)(F), Backrest Cushion Interior(Square)(H), Backrest Cushion Cover(Rectangle)(I), Arm Pillow(J), Small Boxes, and Hermetic Bags from the carton, and place them on a clean, non-marring surface.

## Step 2

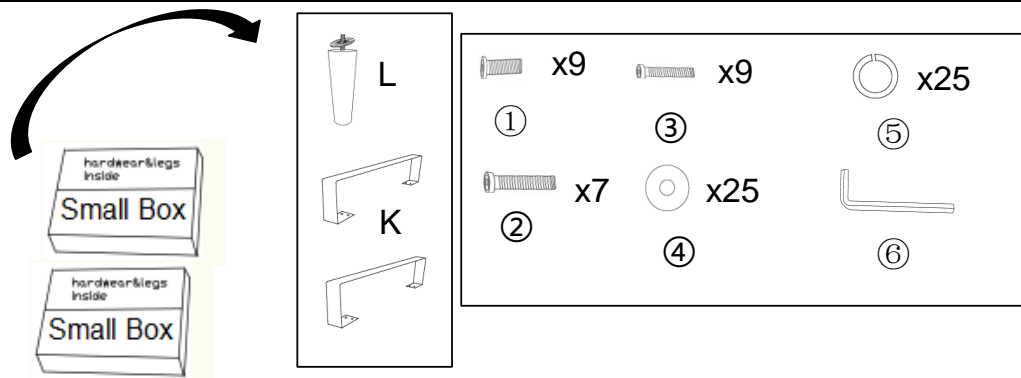

Open the Box and take out the Metal Legs(K), Wooden Leg(L) and Hardware.

## Step 3

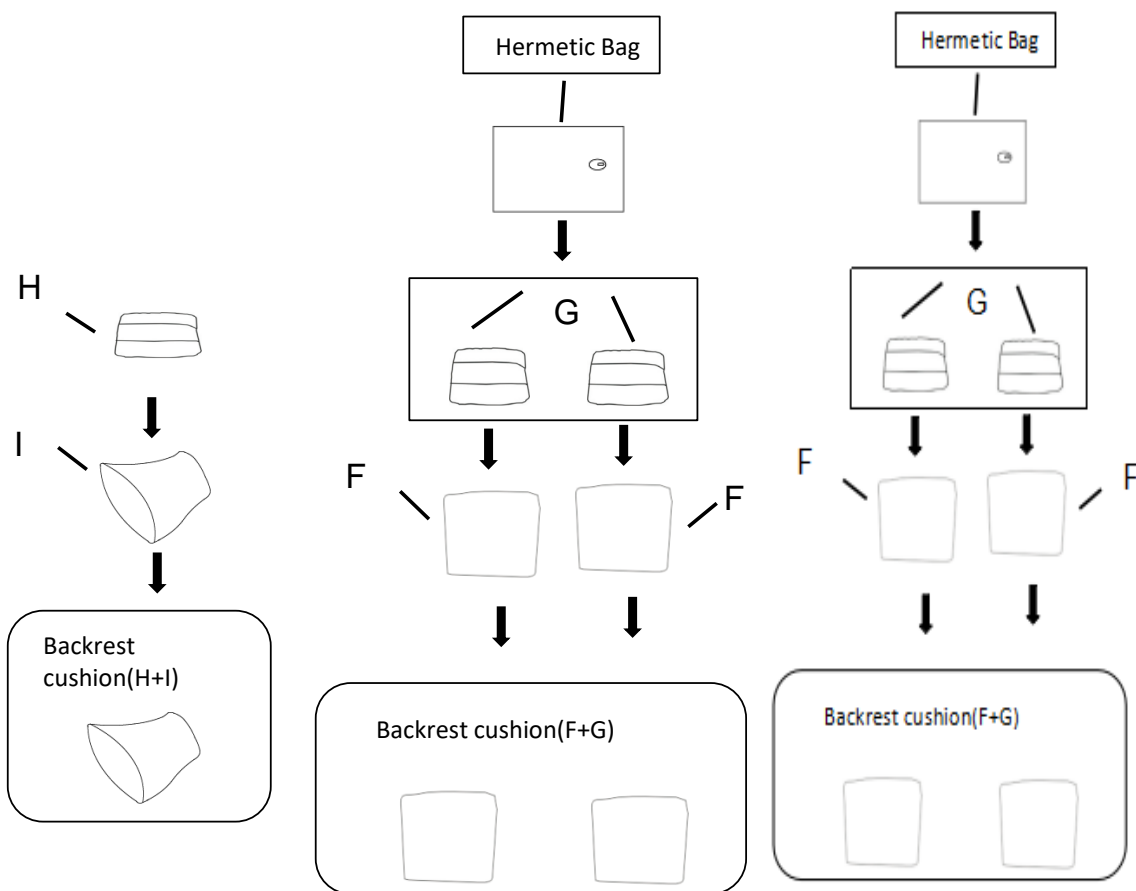

Then take out the 4 Back Cushion Interiors(Square)(G) from the Hermetic Bags. Place each Back Cushion Interior(Square)(G) into a Back Cushion Cover(Square)(F). Repeat the same process to place Backrest Cushion Interior(Rectangle)(H) into the Back Cushion Covers(Rectangle)(I).

## Step 4

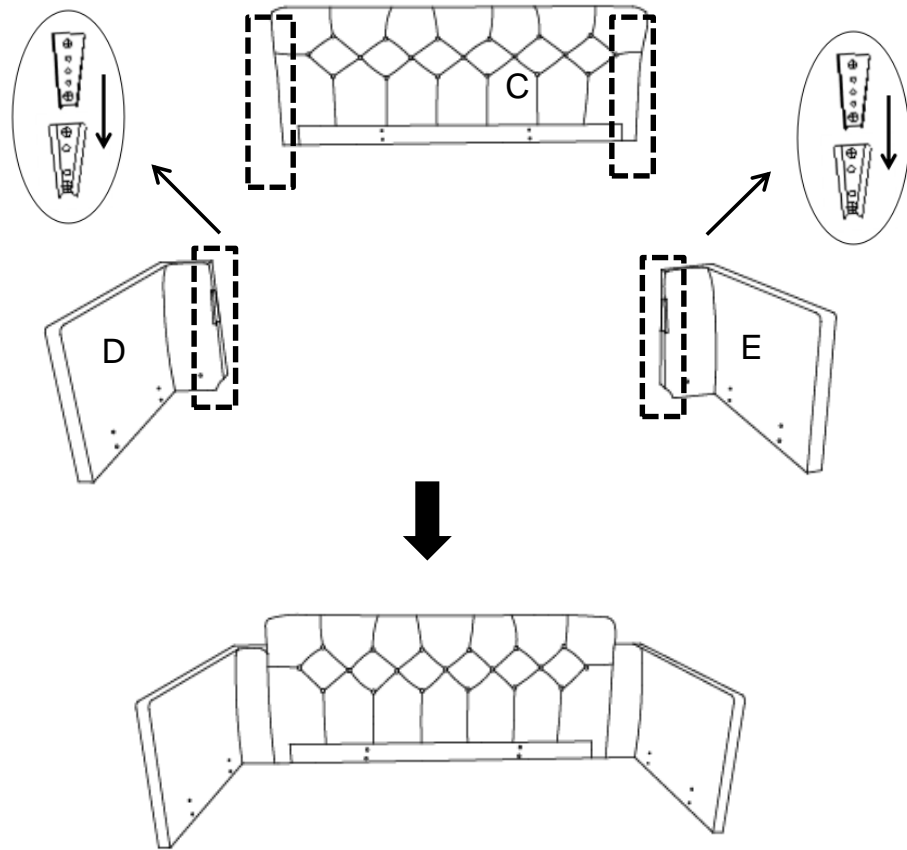

With assistance from your adult partner, align the mounting bracket on the left side of Sofa Backrest(C) with the Left Arm(D) and Right Arm(E), then slide the Sofa Backrest(C) downwards to make sure it locks in place as pictured.

Please squeeze the arm properly against the Sofa Backrest(C) to ensure that the inserts can be assembled smoothly.

## Step 5

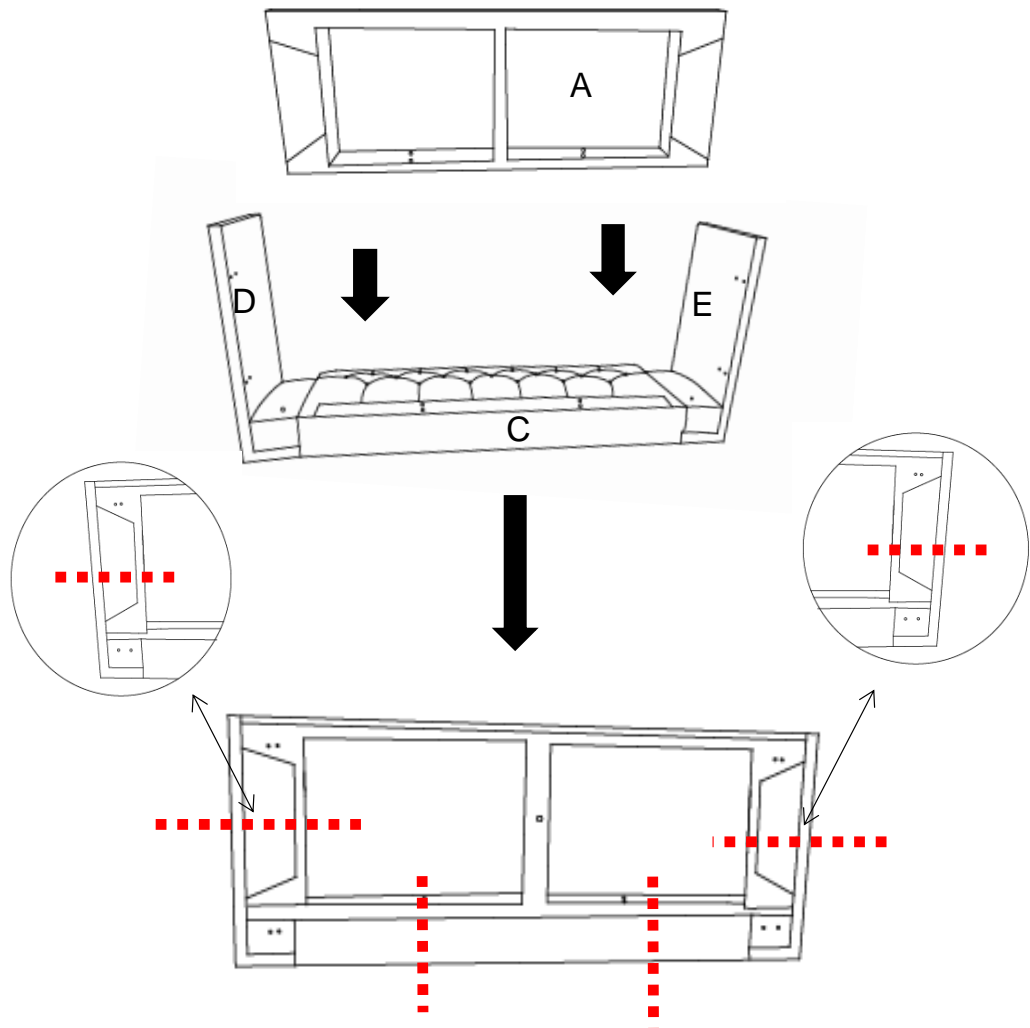

With assistance from your adult partner, align the mounting positions on both sides of the Sofa Base(A) to the mounting positions on the Left Arm(D), Right Arm(E) and Sofa Backrest(C), ensuring the bottom of the Sofa Base(A), Sofa Backrest(C), Left Arm(D) and Right Arm(E) are at the same level.



## Step 6

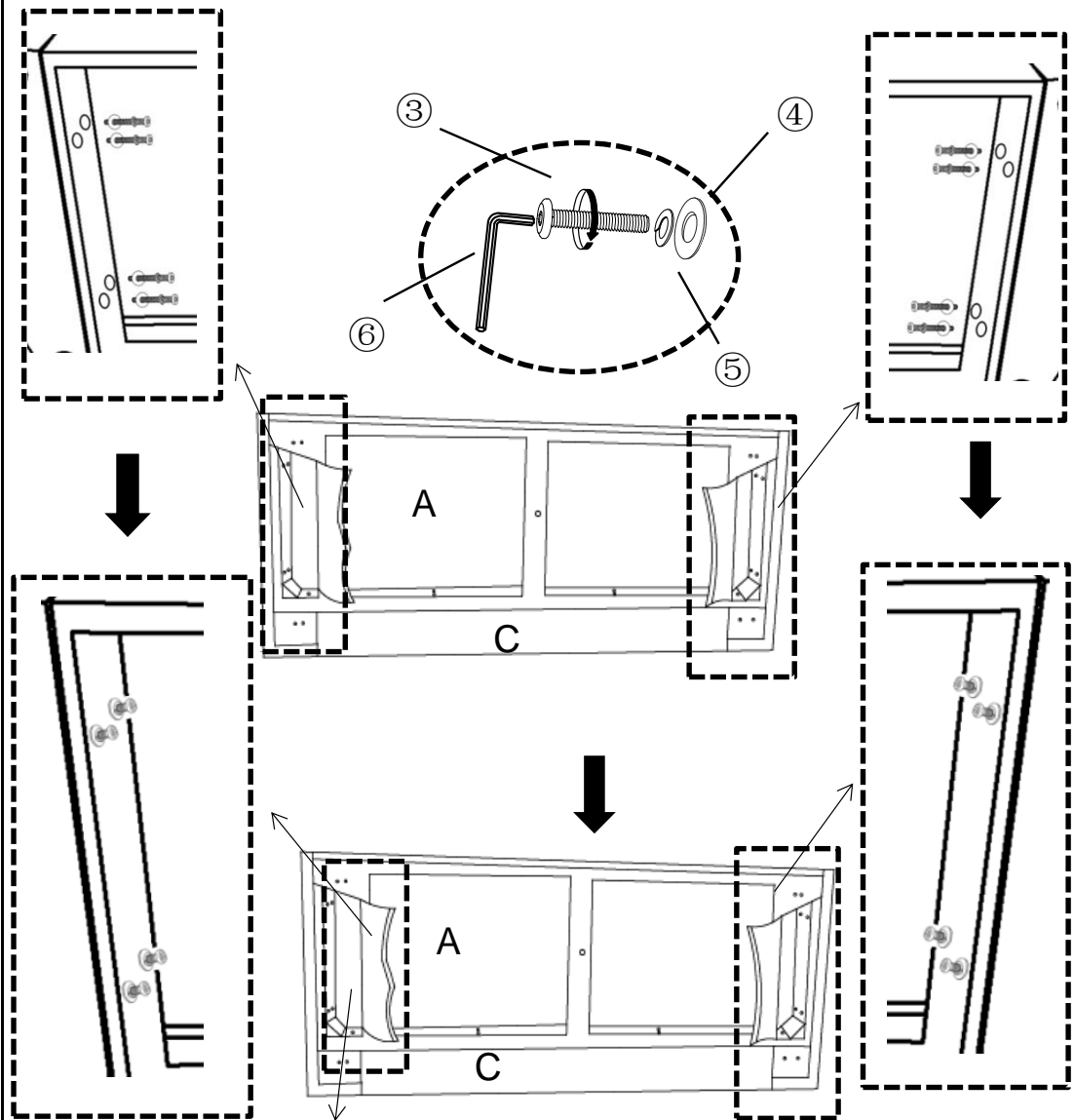

Open the non-woven cover under the Sofa Base(A).

Then secure the Sofa Base(A) to the Sofa arms using Bolts(③), Spring Washers(⑤) and Washers(④) with the Allen Wrench(⑥).

**Do not over tighten.**

**Note: The bottom of the Sofa Base(A) must be aligned with the bottom of the armrests.**

**Step 7**

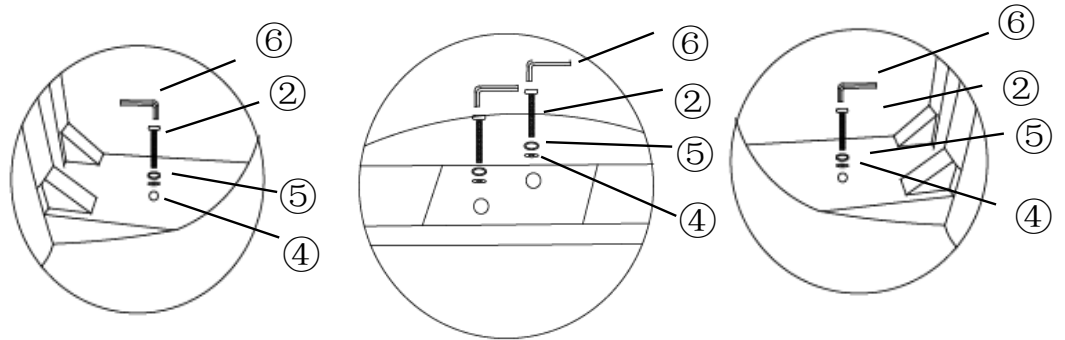
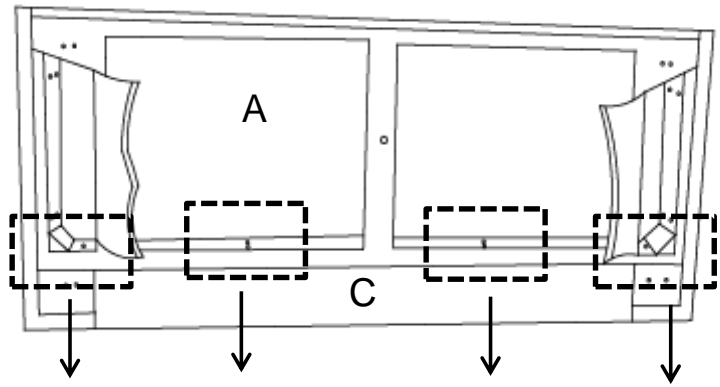

**⚠ Insert the 6 Bolts(②) half-way until all Bolts have been inserted, then proceed to tighten them in using the Allen Wrench(⑥)**

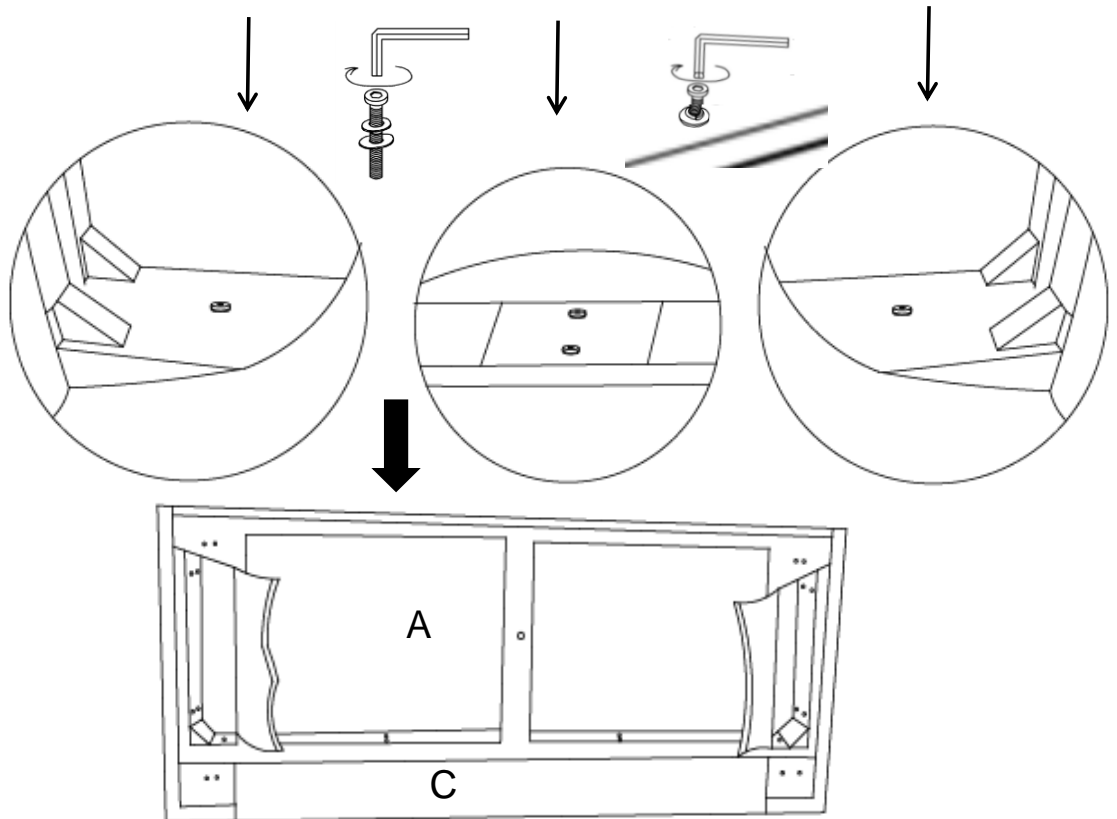

Using the Allen Wrench(⑥) secure the Sofa Base(A) to the front-bottom of the Sofa Backrest(C) with the Bolts(②), Spring Rings(⑤)and Washers(④).

Insert all 6 Bolts(②) half-way starting one by one as pictured.

**Then completely tighten the Bolts(②) together with Bolts(③) in Step 6 using the Allen Wrench(⑥).**

Close the non-woven fabric under the Sofa Base(A) along the Magic Tape.

### Step 8

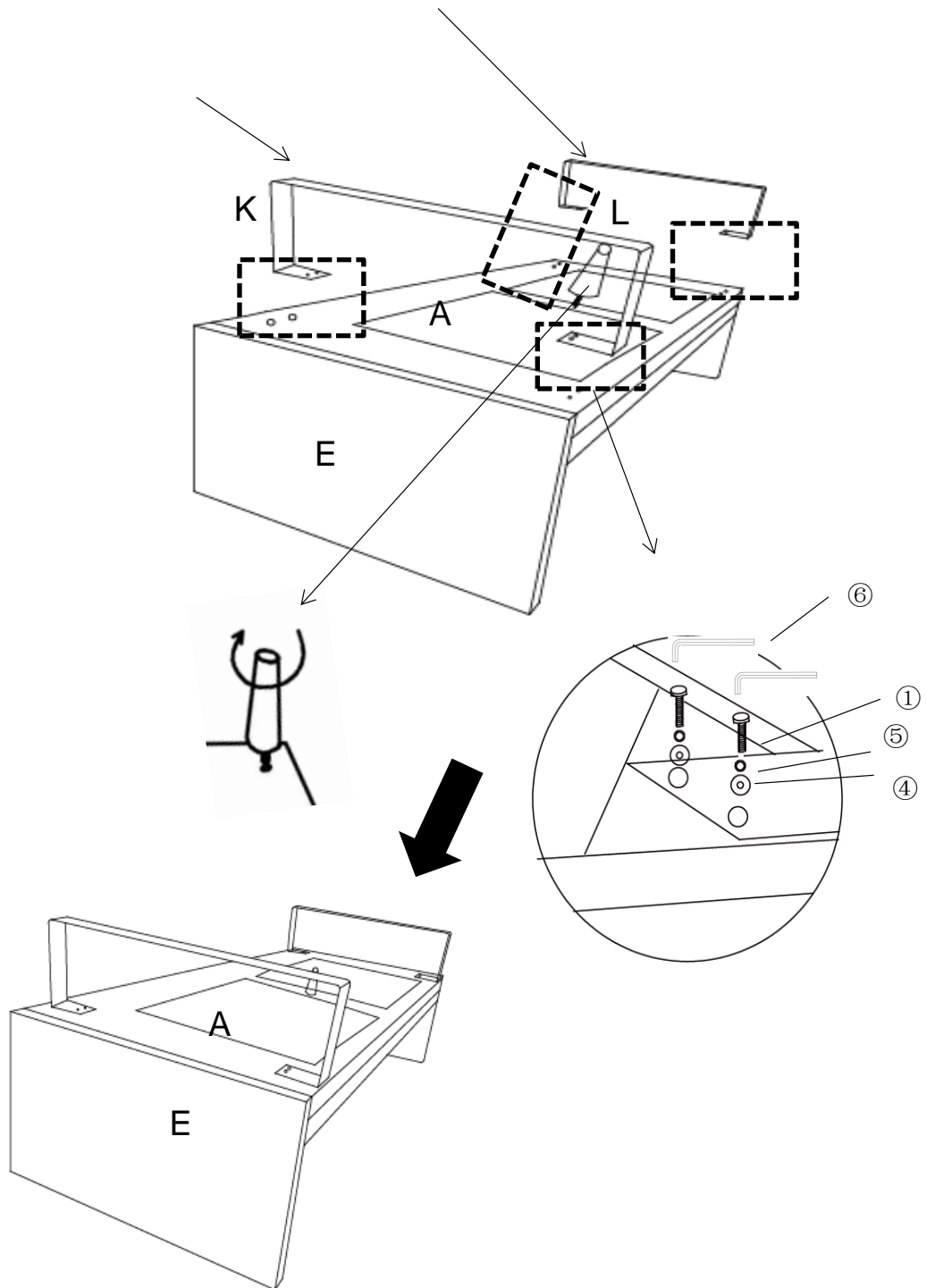

Attach the Metal Legs(K) to the Sofa Base(A) using Bolts(①), Spring Washers(⑤) and Washers(④) with the Allen Wrench((⑥)).

Tighten the Bolts fully in a sequential manner.

Install the Middle Wooden Leg(L) onto the bottom of the Sofa Base(A) by placing one Gasket on the threaded stem.

**Tighten by turning the Leg clockwise.**

**Note: The use of Gaskets are OPTIONAL and are especially useful to help alleviate slight wobbles.**

## Step 9

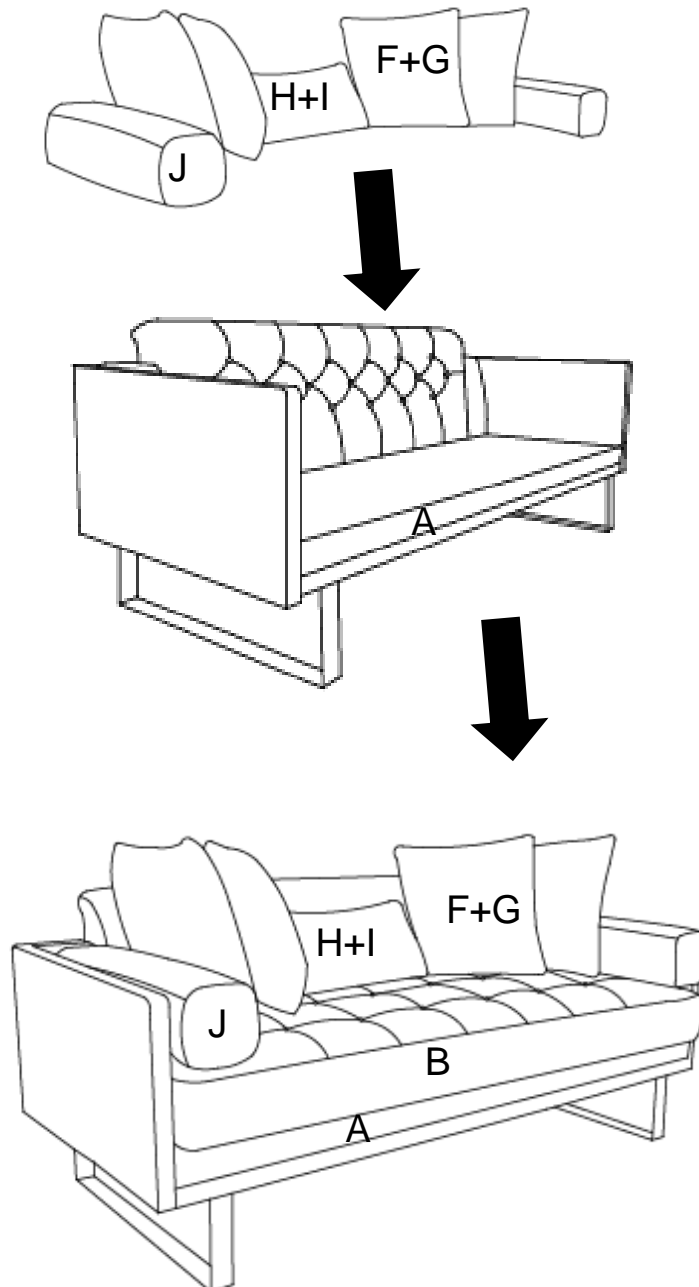

With assistance from your adult partner, turn the Sofa up as pictured.

Place the Seat Cushion(B) on the Sofa Base(A).

Then place the Backrest cushions(F+G), Backrest Cushions(H+I) and Arm Pillows(J) onto the Seat Cushion(B).

## Step 10



There is a leveller under the middle leg, which can be used to adjust the height of the leg, turning it clockwise to increase the height or turning it counterclockwise to reduce the height.

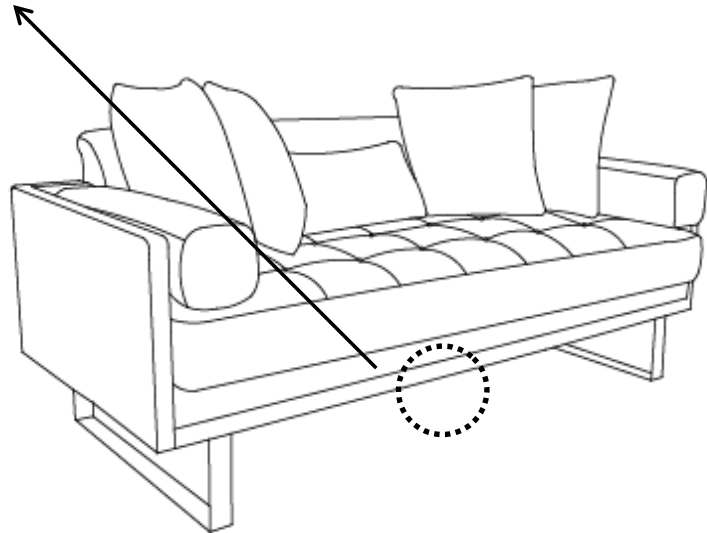









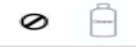

Note: If the sofa is unstable, you can adjust the leveller under the Middle Wooden Leg(L) to make it more stable.

**Your Sofa is ready for use.**

**This Sofa can only be used on a flat, level surface.**

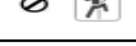
## Care & Maintenance

	<ul style="list-style-type: none"> <li>Furniture may scratch floors. We recommend using furniture pads to protect your floors.</li> </ul>
	<ul style="list-style-type: none"> <li>Do not put hot items directly on furniture surface.</li> </ul>
	<ul style="list-style-type: none"> <li>Do not clean furniture with harsh cleansers or polish.</li> </ul>
	<ul style="list-style-type: none"> <li>Do not place furniture under direct sunlight.</li> </ul>
	<ul style="list-style-type: none"> <li>Do not place furniture near heating or cooling vents.</li> </ul>
	<ul style="list-style-type: none"> <li>Do not write on furniture without a padded barrier to protect the surface.</li> </ul>
	<ul style="list-style-type: none"> <li>Do not place furniture outside . For indoor use only.</li> </ul>
	<ul style="list-style-type: none"> <li>Not for commercial use. For residential use only.</li> </ul>
	<ul style="list-style-type: none"> <li>Stains may be removed with mild soap solution and damp cloth.</li> </ul>
	<ul style="list-style-type: none"> <li>Children should not climb or jump on the furniture.</li> </ul>
	<ul style="list-style-type: none"> <li>Dust and pick-up spills using a clean, non-colored, lint-free cloth.</li> </ul>

### Questions & Answers about Proposition 65

#### • What is Proposition 65?

Proposition 65 requires businesses to provide warnings to Californians about significant exposures to chemicals that cause cancer, birth defects or other reproductive harm. These chemicals can be in the products that Californians purchase, in their homes or workplaces, or that are released into the environment. By requiring that this information be provided, Proposition 65 enables Californians to make informed decisions about their exposures to these chemicals.

Proposition 65 also prohibits California businesses from knowingly discharging significant amounts of listed chemicals into sources of drinking water.

Proposition 65 requires California to publish a list of chemicals known to cause cancer, birth defects or other reproductive harm. This list, which must be updated at least once a year, has grown to include approximately 900 chemicals since it was first published in 1987.

#### • What types of chemicals are on the Proposition 65 list?

The list contains a wide range of naturally occurring and synthetic chemicals that include additives or ingredients in pesticides, common household products, food, drugs, dyes, or solvents. Listed chemicals may also be used in manufacturing and construction, or they may be byproducts of chemical processes, such as motor vehicle exhaust.

#### • What does a warning mean?

If a warning is placed on a product label or posted or distributed at a workplace, a business, or in rental housing, the business issuing the warning is aware or believes that it is exposing individuals to one or more listed chemicals.

By law, a warning must be given for listed chemicals unless the exposure is low enough to pose no significant risk of cancer or is significantly below levels observed to cause birth defects or other reproductive harm.

#### • Where can I get more information on Proposition 65?

If you have specific questions on the administration or implementation of Proposition 65, you can contact OEHHA's Proposition 65 program at [P65.Questions@oehha.ca.gov](mailto:P65.Questions@oehha.ca.gov), or by phone at (916) 445-6900.