

Assembly Instruction

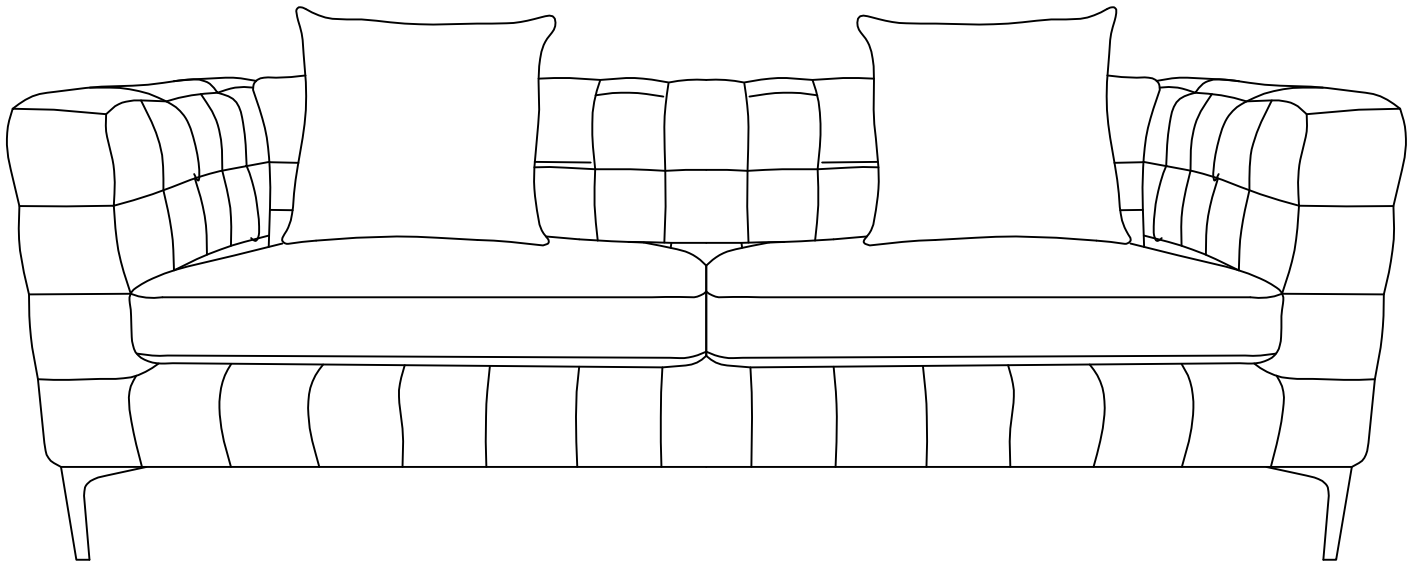

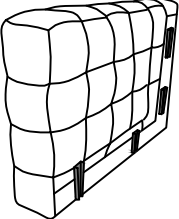

Sofa

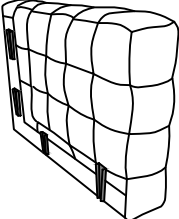
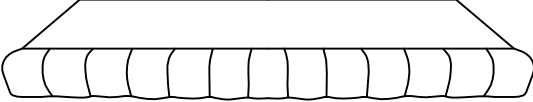
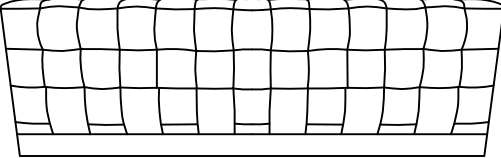
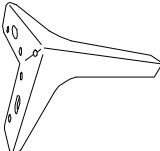
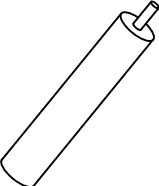
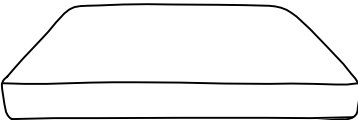
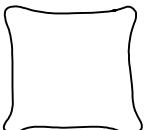

Parts List

Label	Picture	Description	QTY
AL	 A perspective view of a rectangular, tufted armrest with a grid of stitching on its top surface.	Left Armrest	1
AR	 A perspective view of a rectangular, tufted armrest, similar to the left armrest but mirrored.	Right Armrest	1
B	 A perspective view of a rectangular, tufted seat cushion with a grid of stitching on its top surface.	Seat	1
C	 A perspective view of a rectangular, tufted backrest with a grid of stitching on its top surface.	Backrest	1
D	 A perspective view of a single, Y-shaped leg component with a pointed end.	Leg	4
E	 A perspective view of a cylindrical, tufted mid-leg component.	Mid-Leg	1
F	 A perspective view of a rectangular, tufted seat cushion with a grid of stitching on its top surface.	Seat cushion	2
G	 A perspective view of a square, tufted pillow with a grid of stitching on its top surface.	Pillow	2





Hardware

Label	Picture	Description	QTY
①		Bolt (M8*25MM)	8
②		Washer	8
③		Allen Key	1
④		Plastic washer	1

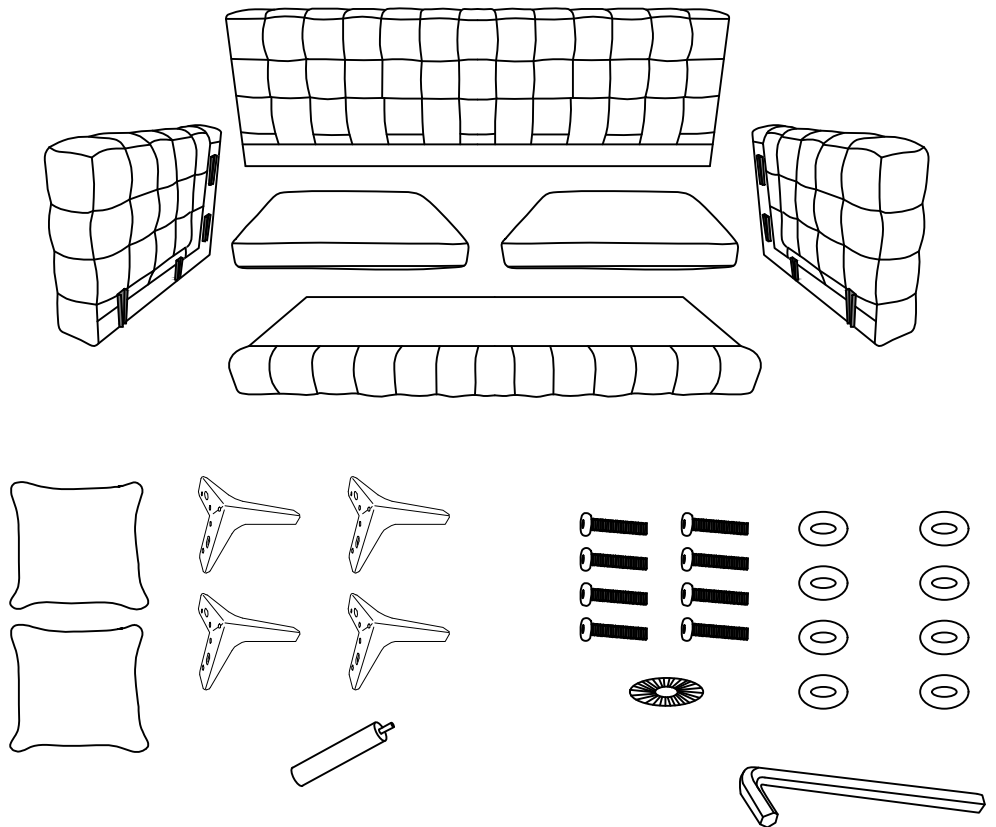
Assembly Preparation

Before Beginning Assembly:



-  ● Read instructions, cover to cover.
-  ● Have 2 adults on hand for assembly.
-  ● Do not assemble on flooring or carpet.
-  ● Assemble on a clean non-marring surface (packing foam).
-  ● Save all packaging until finished.

Step1

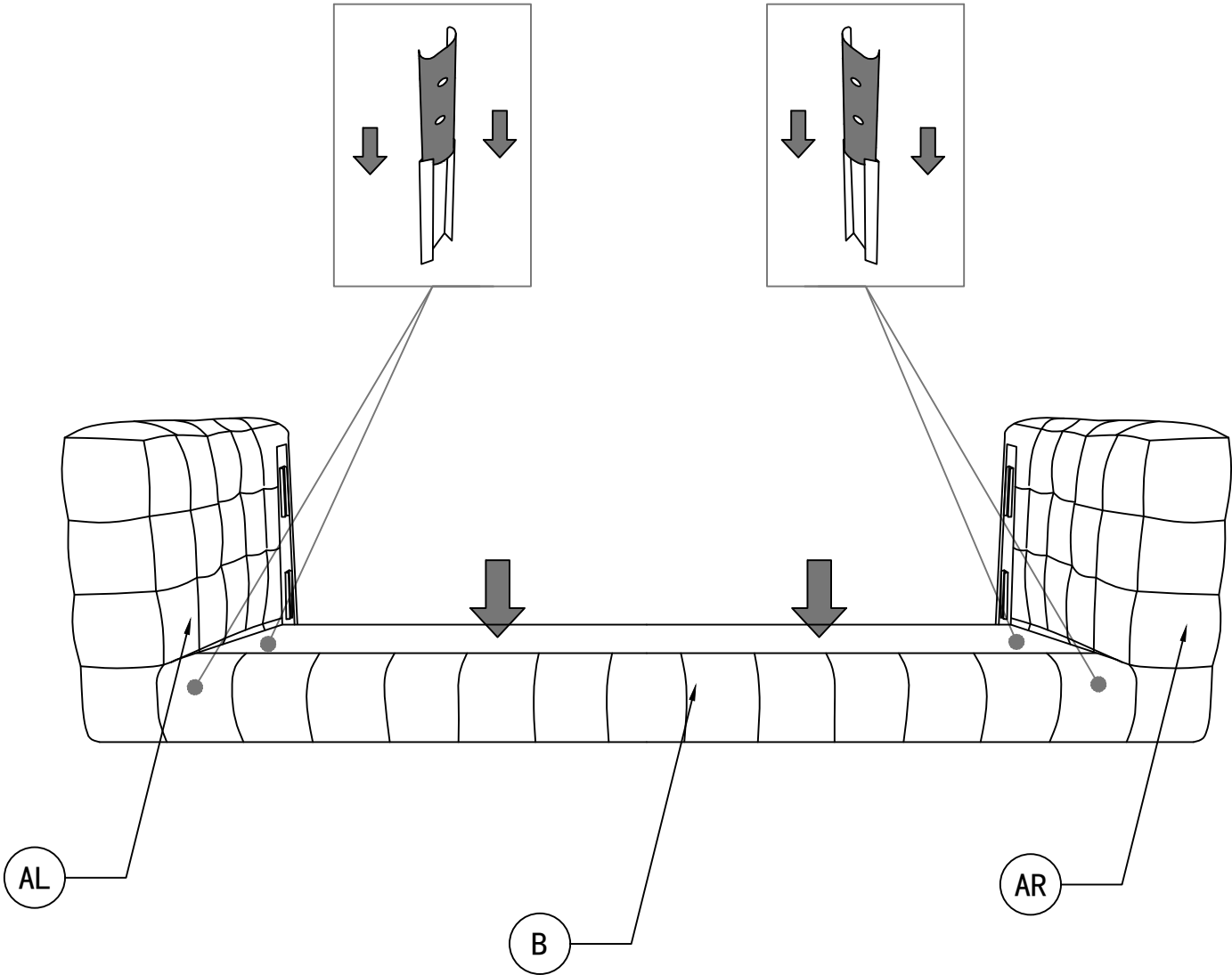

Step2

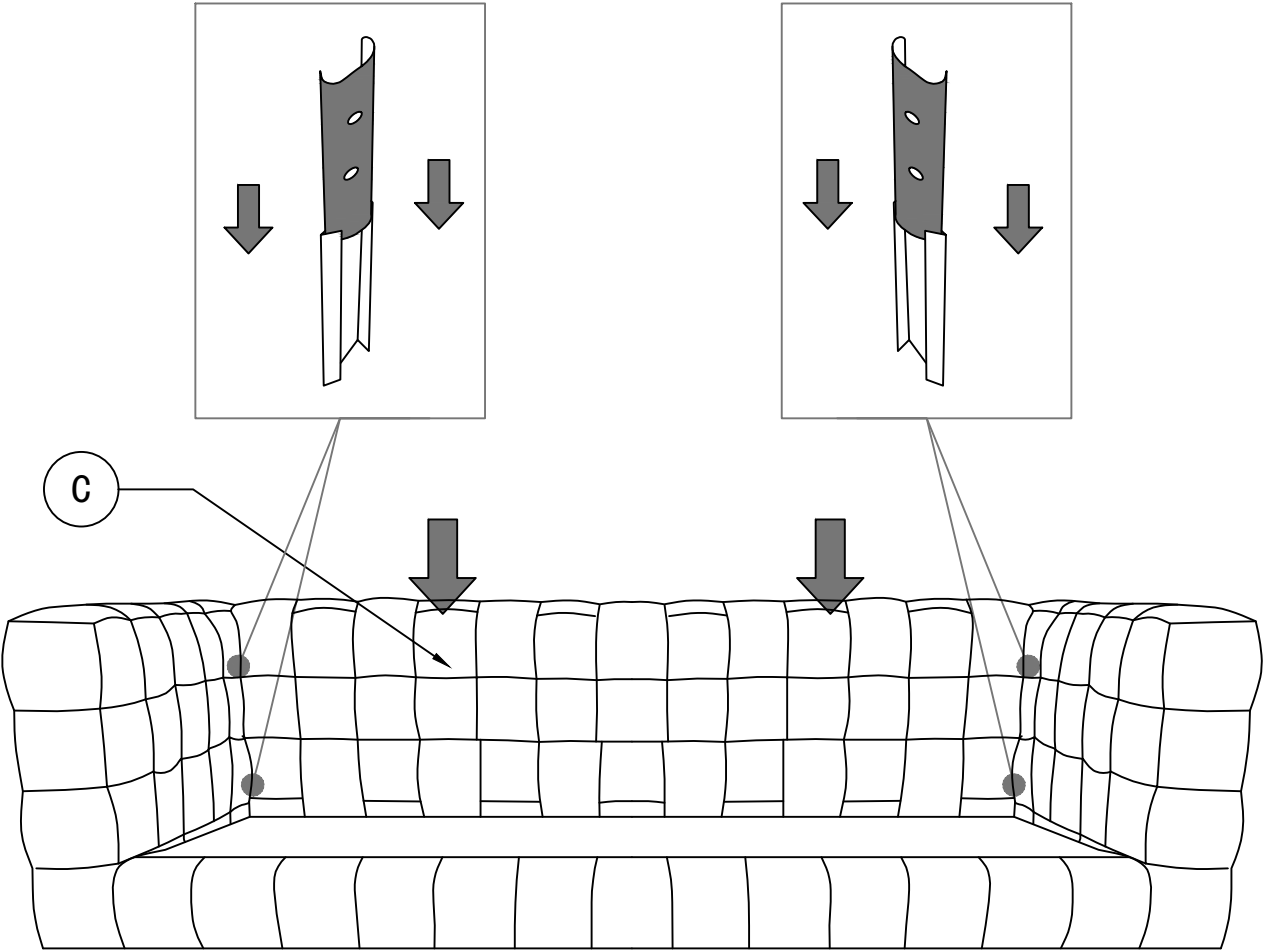

Step3

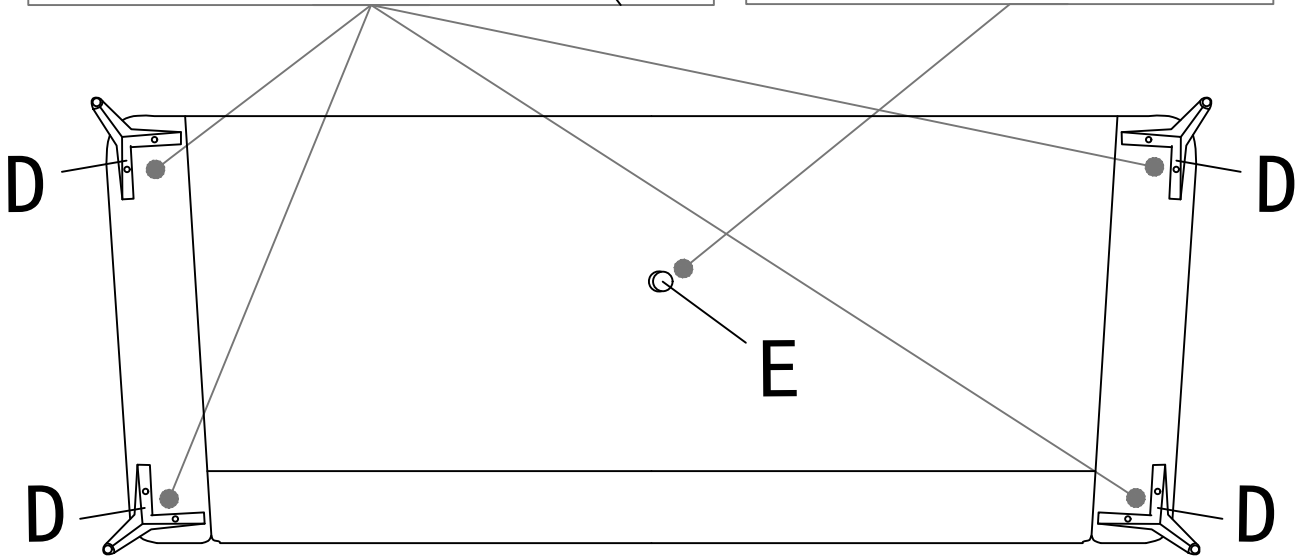
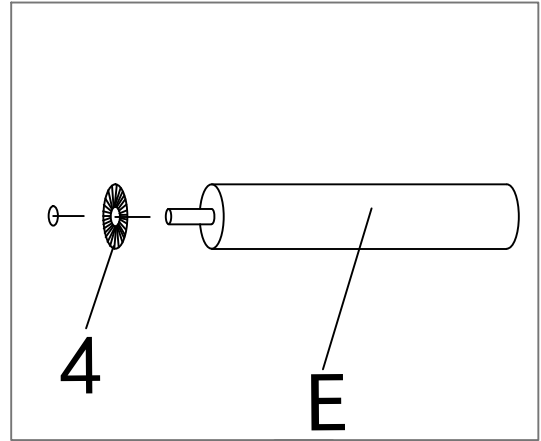
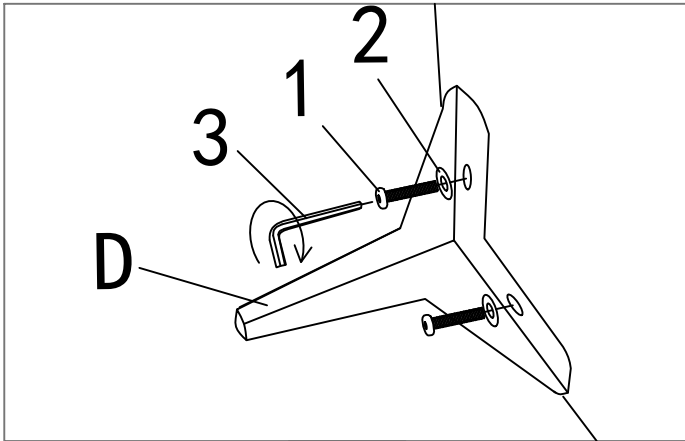
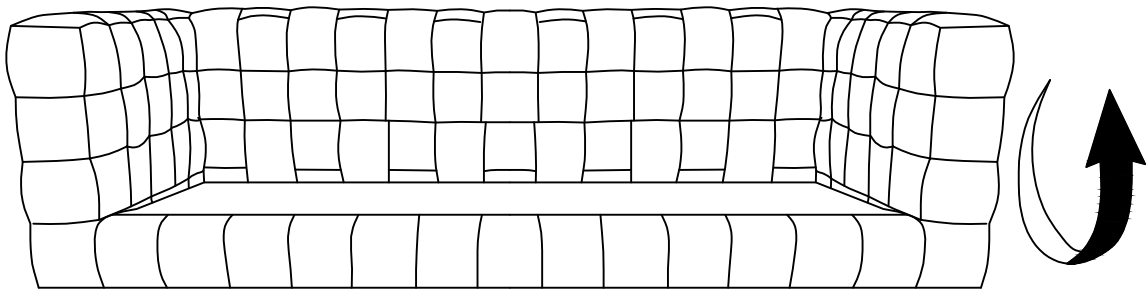

Step4

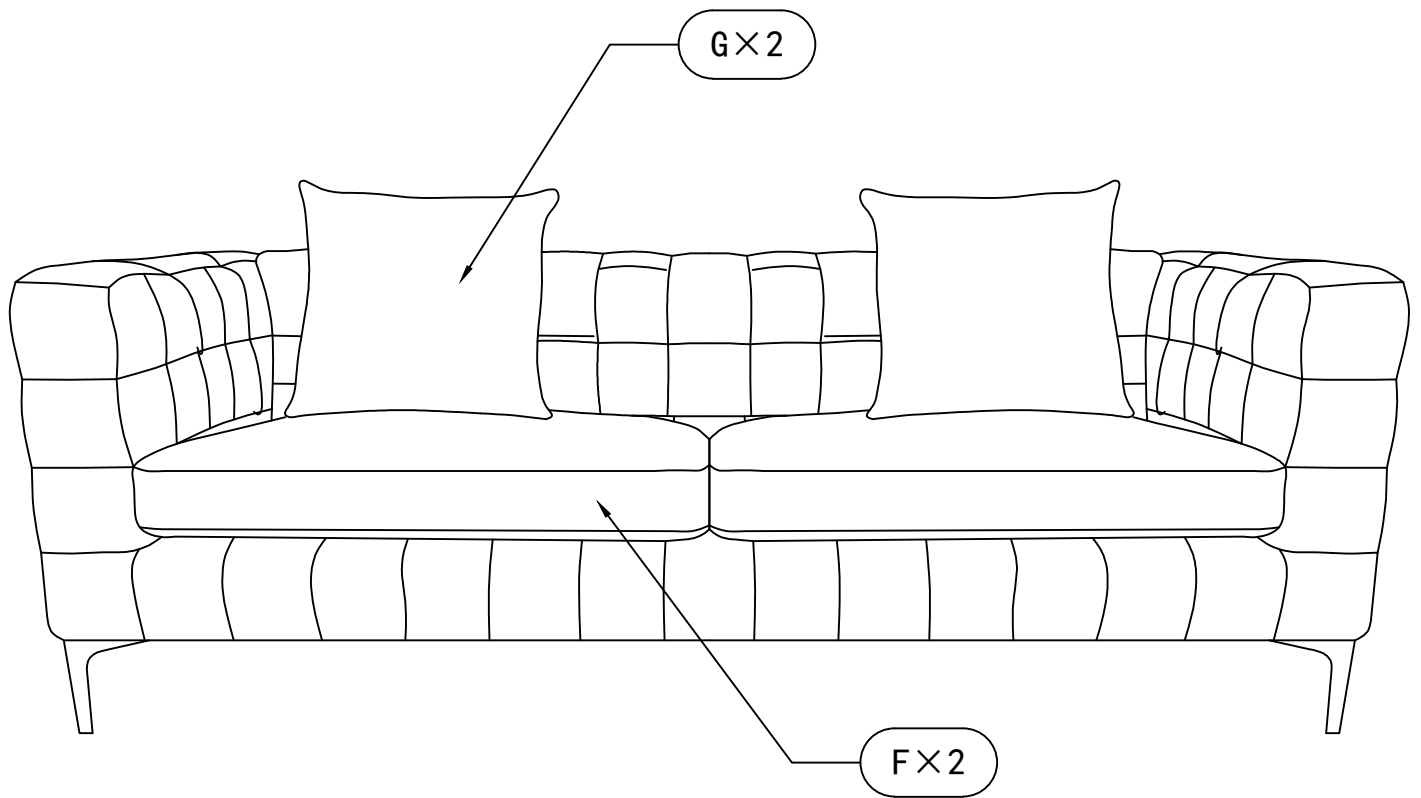



Assembly Instruction

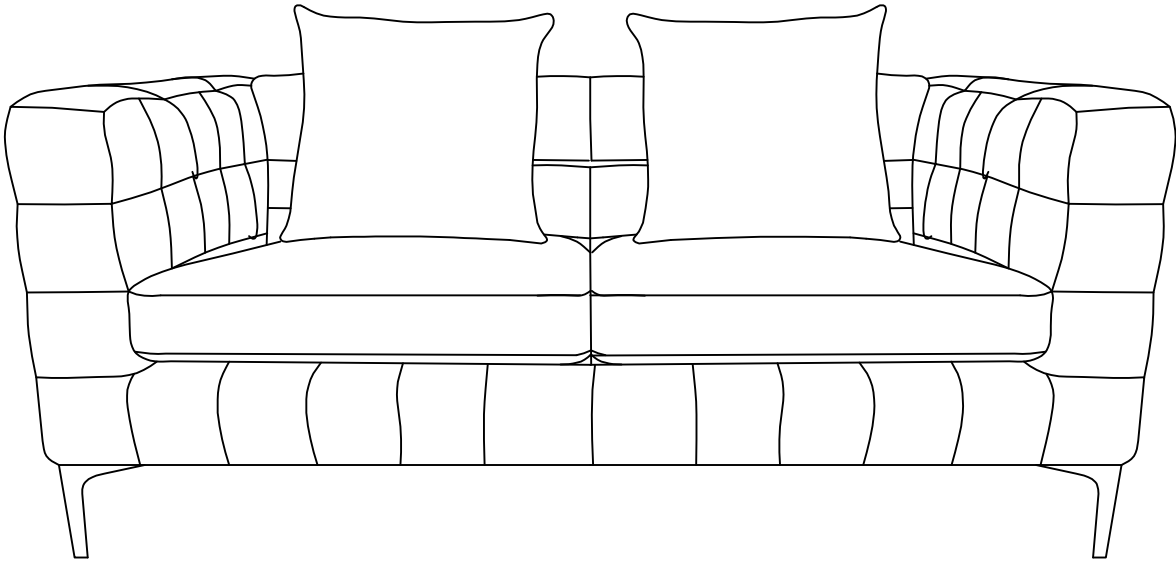

Sofa

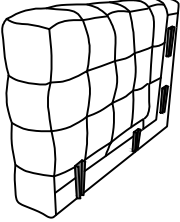
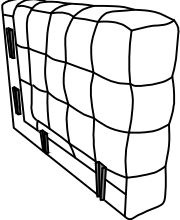
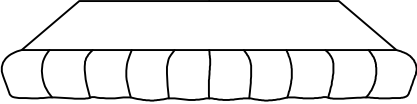
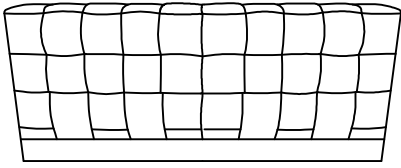
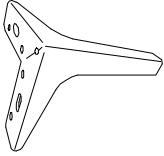

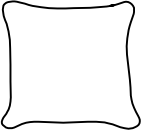
Parts List

Label	Picture	Description	QTY
AL		Left Armrest	1
AR		Right Armrest	1
B		Seat	1
C		Backrest	1
D		Leg	4
E		Seat cushion	2
F		Pillow	2





Hardware

Label	Picture	Description	QTY
①		Bolt (M8*25MM)	8
②		Washer	8
③		Allen Key	1

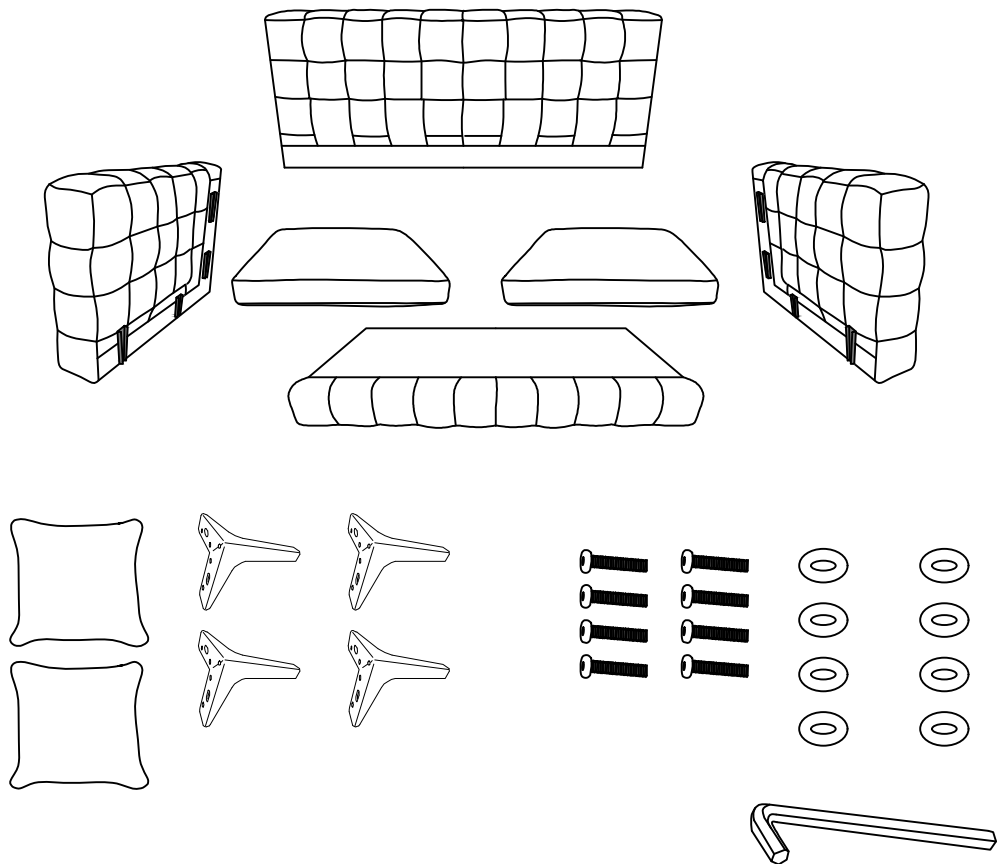
Assembly Preparation

Before Beginning Assembly:



-  ● Read instructions, cover to cover.
-  ● Have 2 adults on hand for assembly.
-  ● Do not assemble on flooring or carpet.
-  ● Assemble on a clean non-marring surface (packing foam).
-  ● Save all packaging until finished.

Step 1

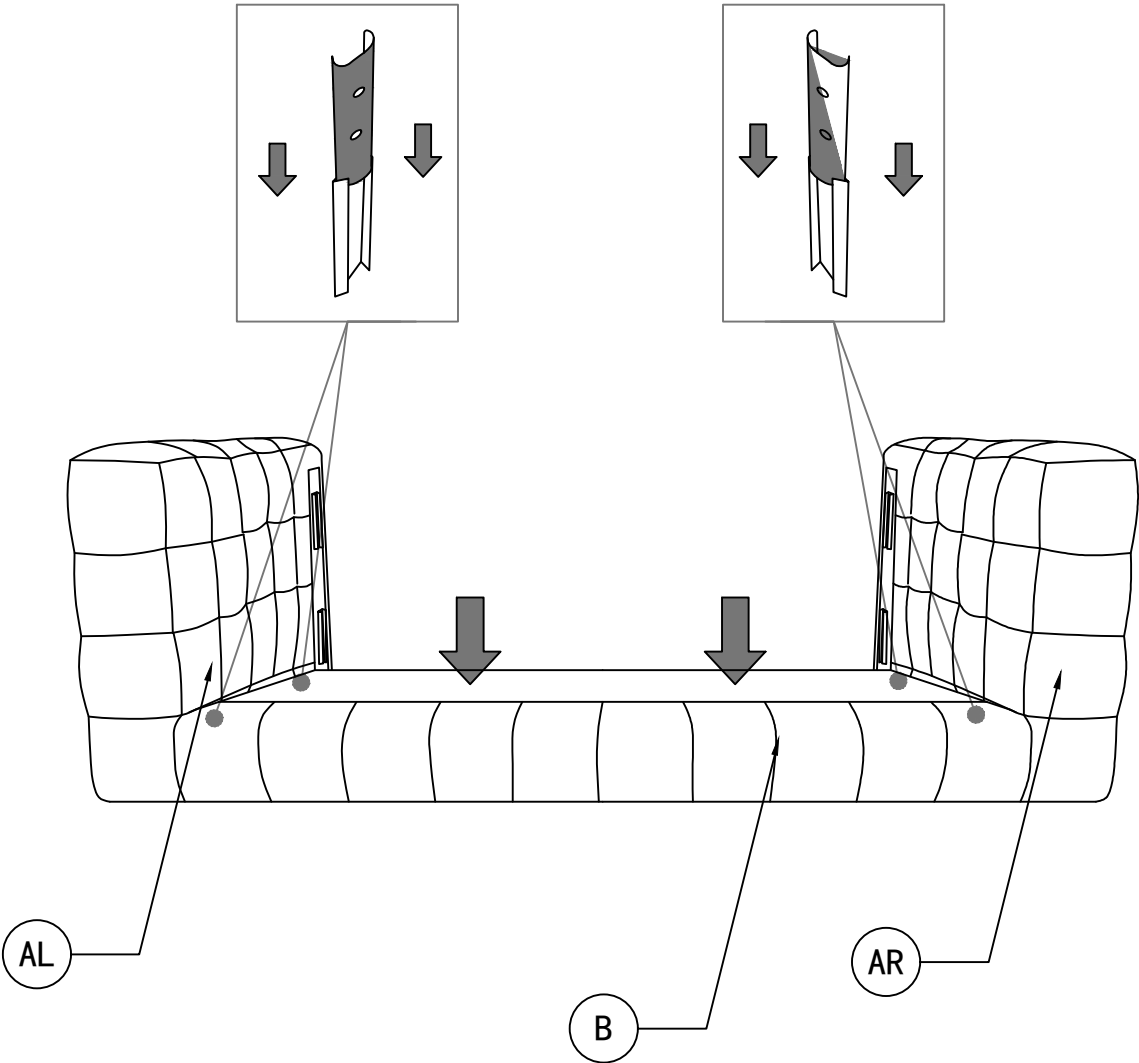

Step2

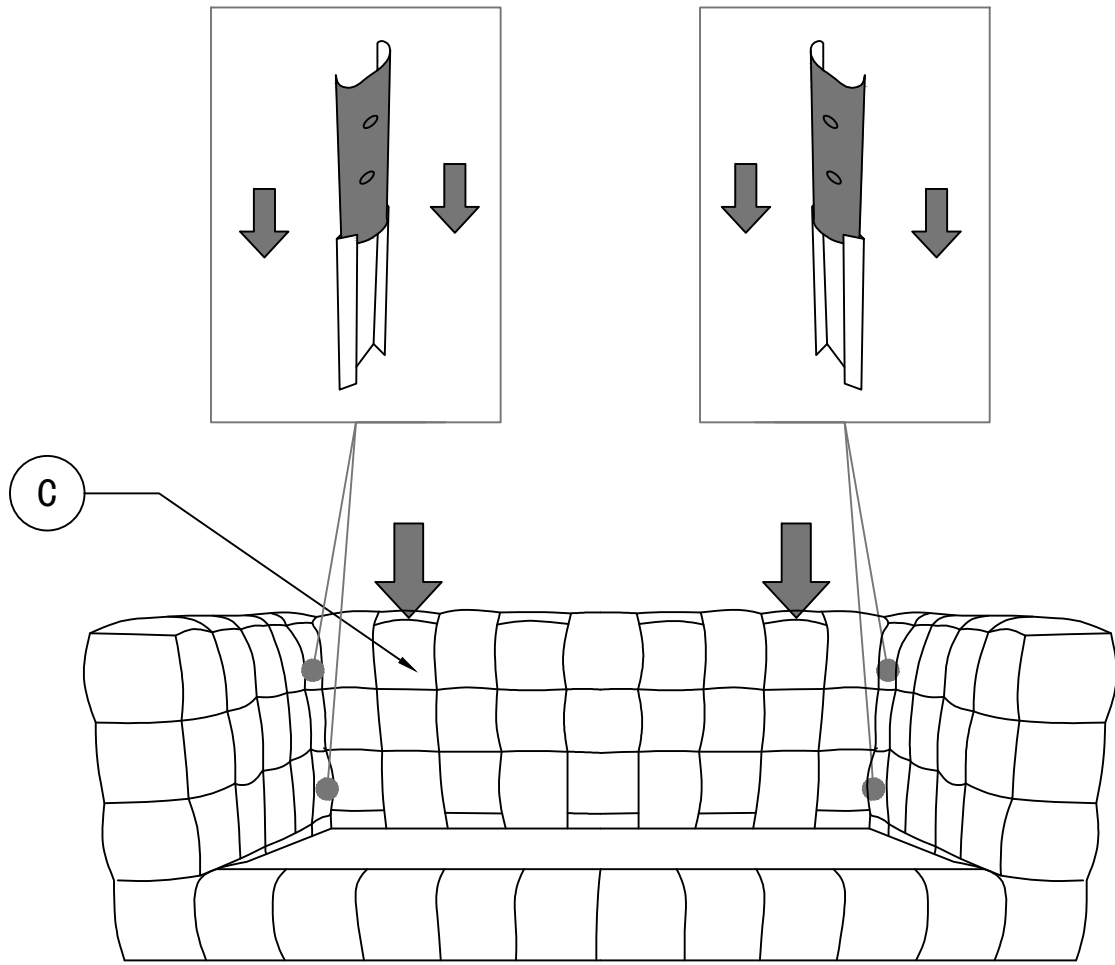

Step3

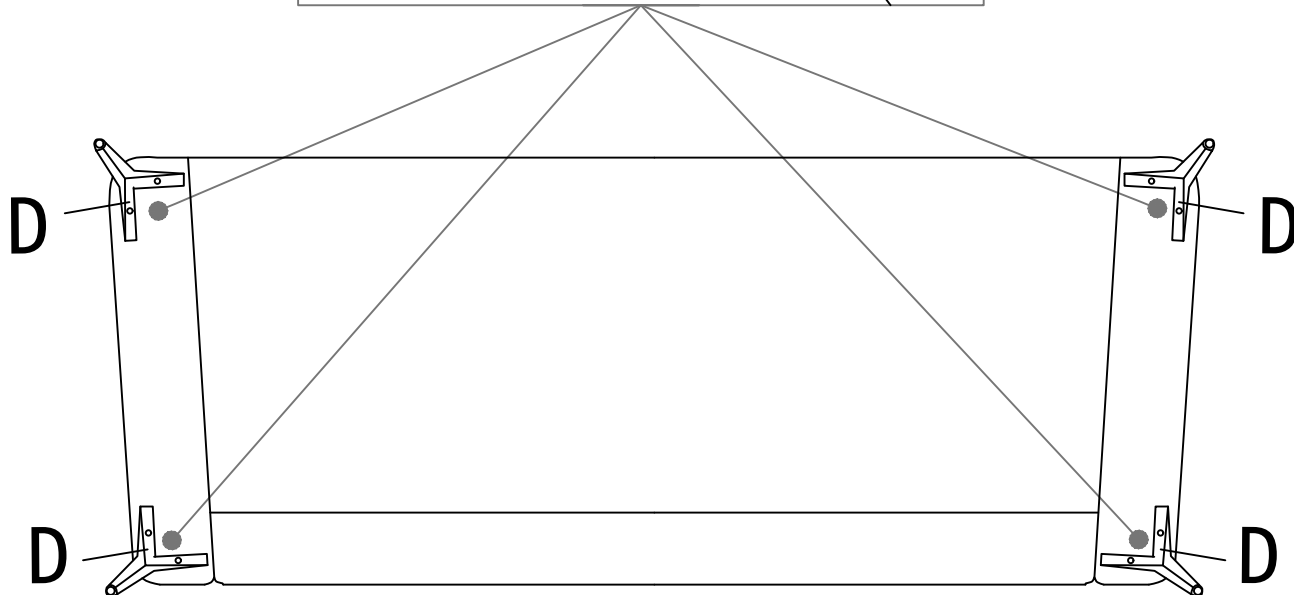
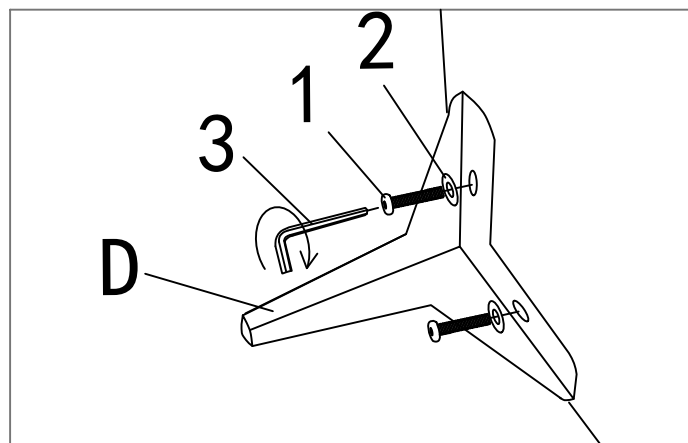
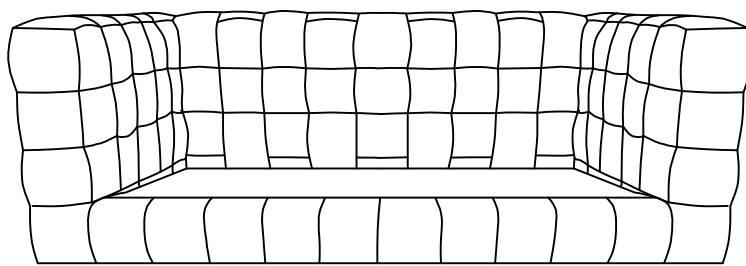

Step4

