

ASSEMBLY INSTRUCTION

W2325P173115

W2325P173113

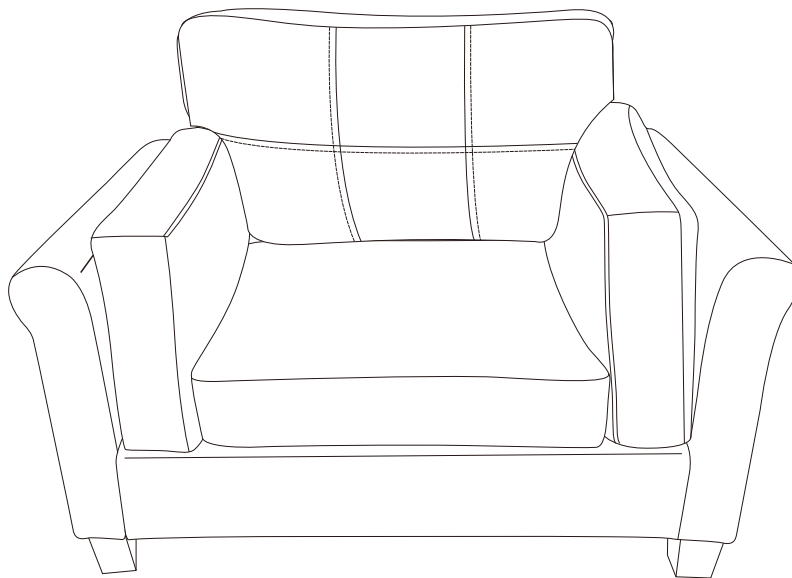

Return & Warranty policy:

-We strive to offer the highest quality products, and we also try our best to satisfy each and every customer that orders from us with replacement parts/or service as needed.

-1.If the items is damaged or defective, please take photos as evidence for replacements and refunds.

-Please do not return to store, contact the seller if you have any troubles with this product.

-2.As the cushions are all vacuum compressed, there will be some wrinkles.

Please give your cushions up to 72 hours to reach its original size and the wrinkles will basically disappear.

-3.Please do not open the compressed packages until your sofa frame is completely assembled.

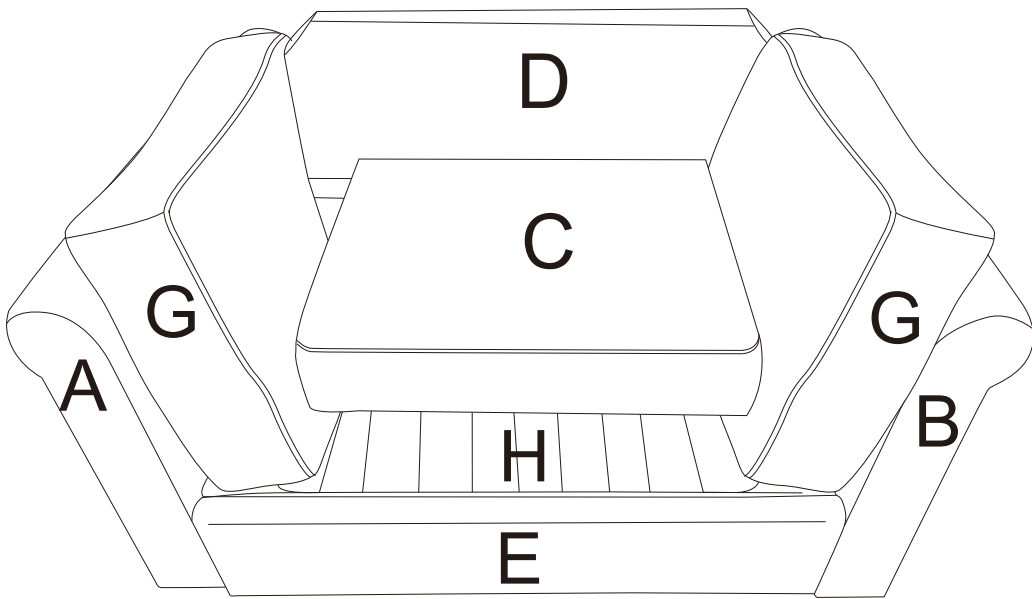
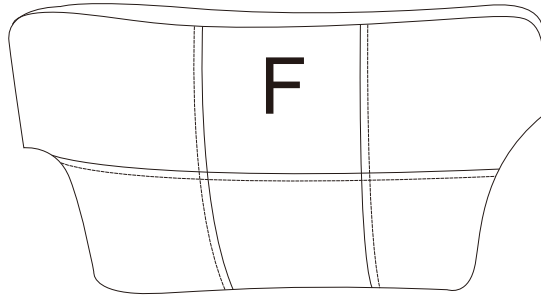

ASSEMBLY INSTRUCTION











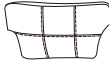
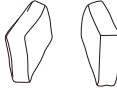
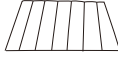

PARTS LIST				
	NO	DESCRIPTION	SKETCH	QTY
W2325P173115 W2325P173113	A/B	LEFT ARM / RIGHT ARM		1PC
	C	SEAT CUSHION		1PC
	D	BACK FRAME		1PC
	E	FRONT BOARD		1PC
	F	BACK CUSHION		PC
	G	ARM CUSHION		2PCS
	H	SEAT SLATS		1PC
	I	LEG		4PCS
	J	SPARE ANTI-SLIP MAT		1PC
	HARDWARE LIST			
	NO	DESCRIPTION	SKETCH	QTY
	1	INSERT		2PCS
	2	SCREWS M8*15MM		8PCS
	3	ALLEN KEY		1PC

DIAGRAM1

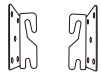
Install The Leg(I)

A		1PC
B		1PC
I		4PC

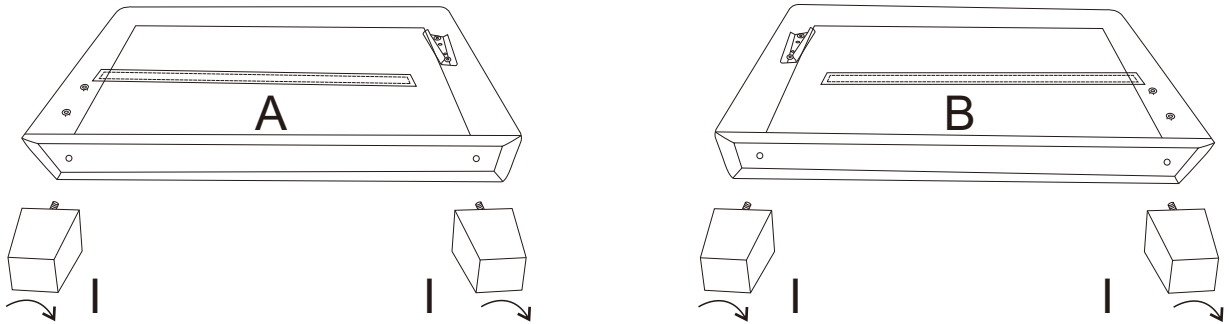

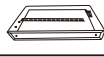



DIAGRAM2

Assemble the Arm(A,B)and the Back Frame(D)

D		1PC
A		1PC
B		1PC

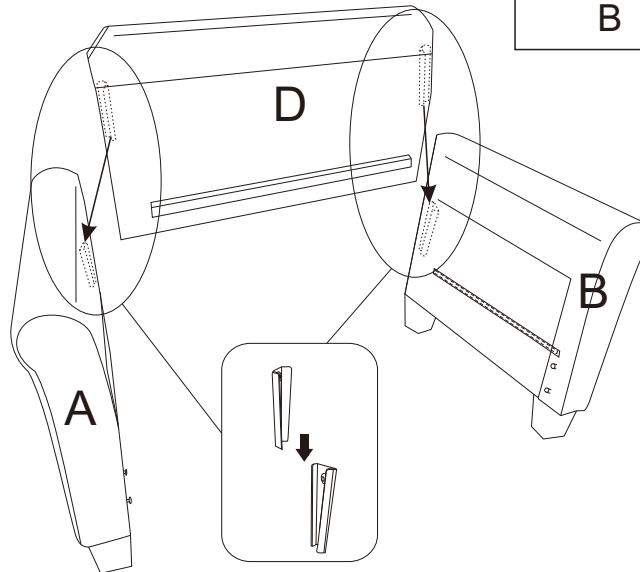

DIAGRAM3

Connect the Insert(1)to the Front Board (E)
with Screws M8*15mm(2)







E		1PC
1		2PCS
2		8PCS
3		1PC



DIAGRAM4

Assemble the Front Board(E)

E		1PC
A		1PC
B		1PC

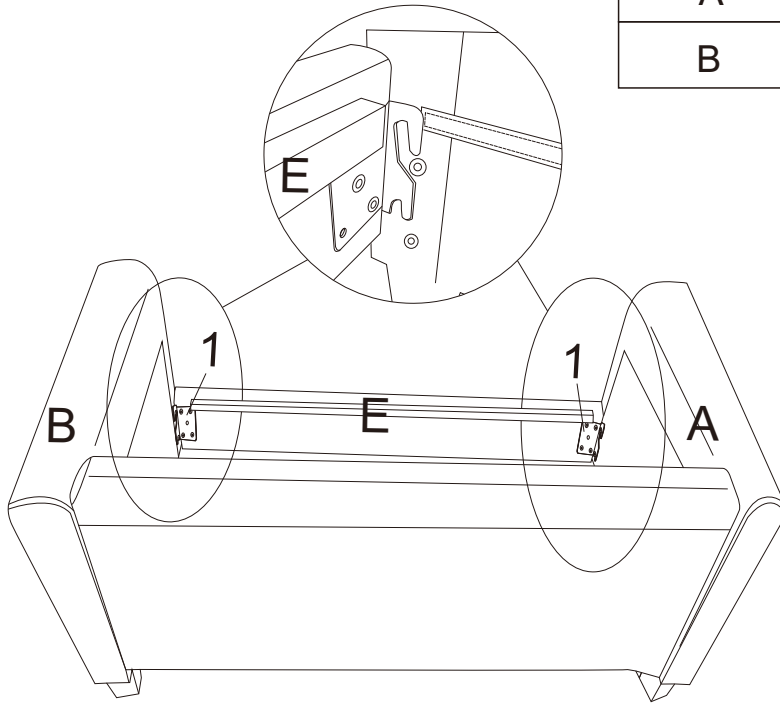
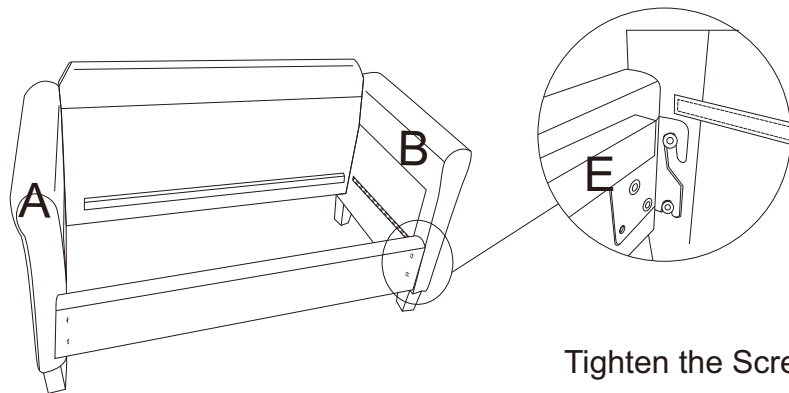





DIAGRAM5



Tighten the Screws

DIAGRAM6

D		1PC
A		1PC
B		1PC

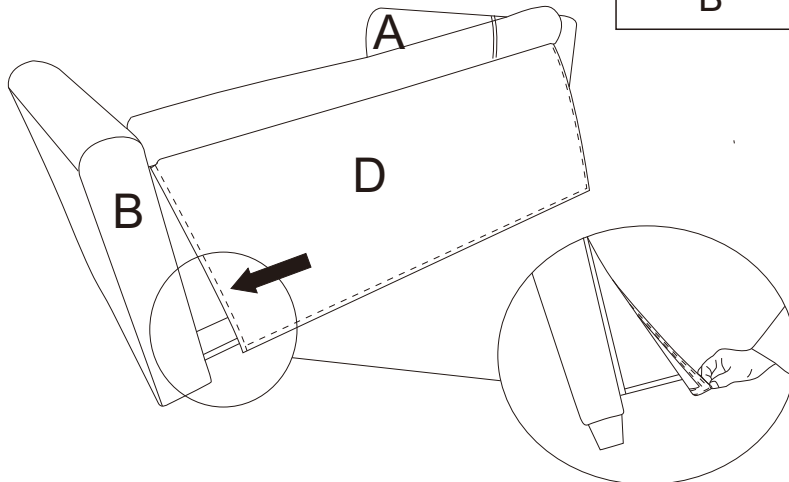
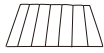

DIAGRAM7

Install Seat Slats(H)

H		1PC
---	------------------------------------------------------------------------------------	-----

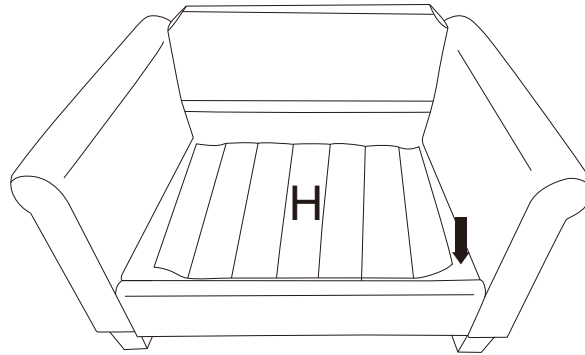

DIAGRAM8

(Removal of compression bags)

Remove the ARM cushion(Parts G) the Seat cushion(Parts C)the Back cushion(Parts F)

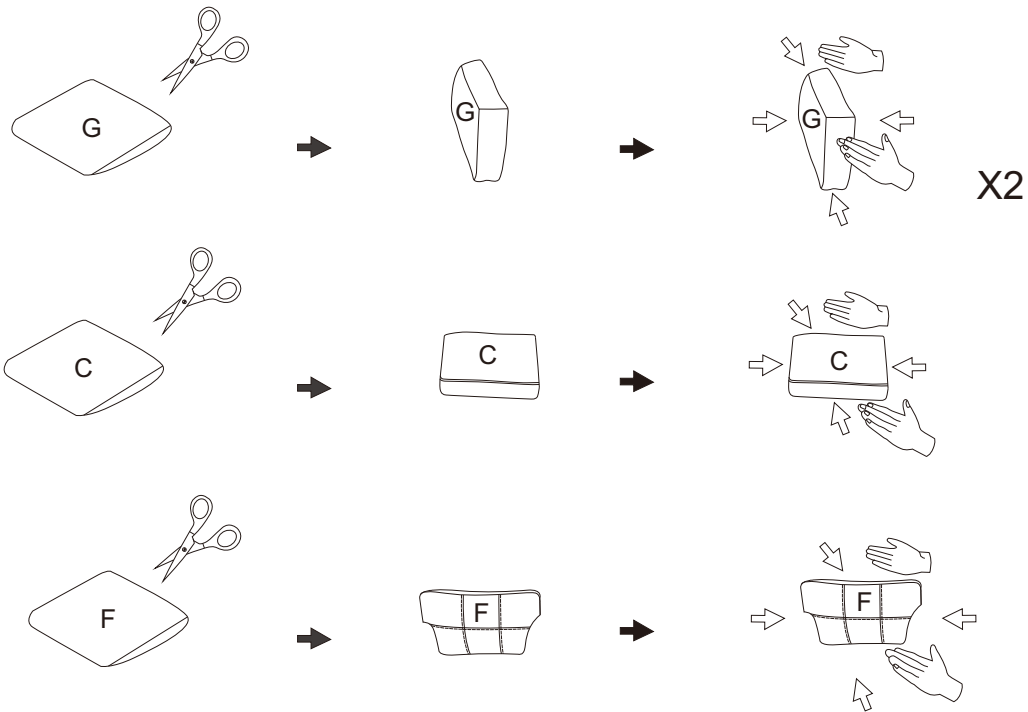

DIAGRAM9

TIPS:

1. Please do not open the compressed packages until your sofa frame is completely assembled.
2. Compressed back cushions and pillows need to be fully fulfilled within 72 hours for your perfect use
3. Please keep children away from plastic bags or any small pieces of stu .

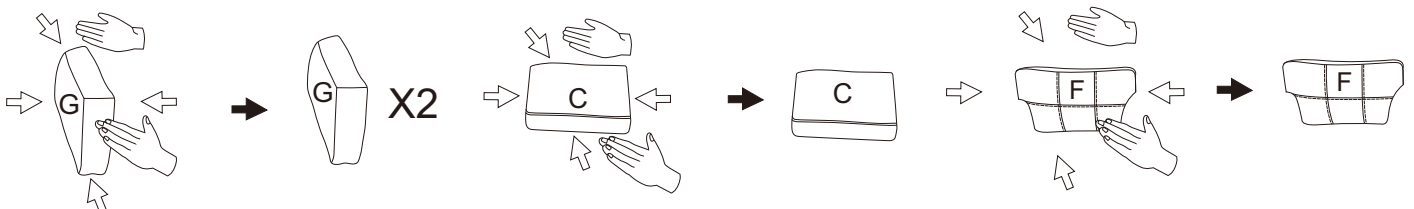



DIAGRAM10

G		2PCS
---	-------------------------------------------------------------------------------------	------

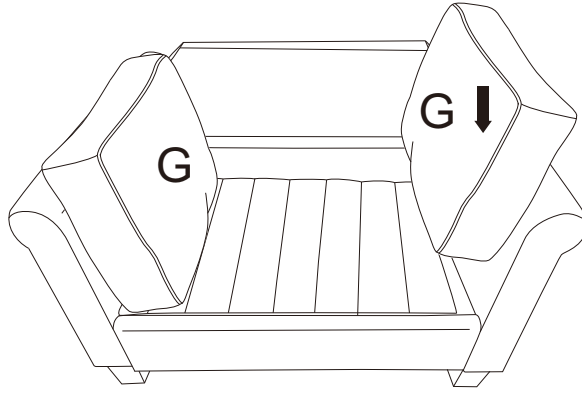

DIAGRAM11

C		1PC
---	-------------------------------------------------------------------------------------	-----

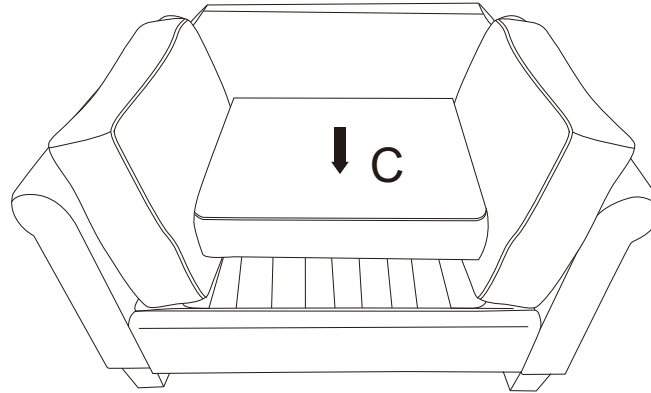

DIAGRAM12

F		1PC
---	---------------------------------------------------------------------------------------	-----

